

- Microhmmètre
- Microhmmeter
- Micro-Ohmmeter
- Microhmmetro
- Micróhmetro

C.A 6240





FRANÇAIS
ENGLISH
DEUTSCH
ITALIANO
ESPAÑOL

Notice de fonctionnement
User's manual
Bedienungsanleitung
Libretto d'Istruzioni
Manual de Instrucciones

 **CHAUVIN®
ARNOUX**
CHAUVIN ARNOUX GROUP

English	23
Deutsch	43
Italiano	63
Español	83

 ATTENTION, risque de DANGER ! Consulter la notice de fonctionnement.
 Dans la présente notice de fonctionnement, les instructions précédées de ce symbole, si elles ne sont pas bien respectées ou réalisées, peuvent occasionner un accident corporel ou endommager l'appareil et les installations.

 Appareil entièrement protégé par isolation double ou isolation renforcée.

 La poubelle barrée signifie que, dans l'Union Européenne, le produit doit faire l'objet d'un tri sélectif des déchets pour le recyclage des matériels électriques et électroniques conformément à la directive WEEE 2002/96/EC.

 Borne de terre.

Définition des catégories de mesure :

- La catégorie de mesure III correspond aux mesurages réalisés dans l'installation du bâtiment.
- La catégorie de mesure II correspond aux mesurages réalisés sur les circuits directement branchés à l'installation basse tension.
- La catégorie de mesure I correspond aux mesurages réalisés sur des circuits non reliés directement au réseau.

Vous venez d'acquérir un **microhmmètre C.A 6240** et nous vous remercions de votre confiance.

Pour obtenir le meilleur service de votre appareil :

- lisez attentivement cette notice de fonctionnement
- respectez les précautions d'emploi

Coller une des 5 étiquettes caractéristique fournies à l'intérieur du couvercle de l'appareil dans la langue appropriée.

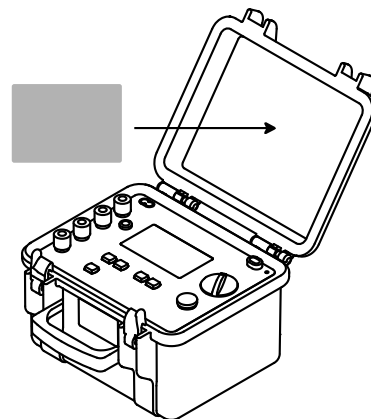

⚠ PRÉCAUTIONS D'EMPLOI ⚠

Cet appareil est protégé contre des tensions accidentelles n'excédant pas 50V par rapport à la terre en catégorie de mesure III. La protection assurée par l'appareil peut-être compromise si celui-ci est utilisé de façon non spécifiée par le constructeur.

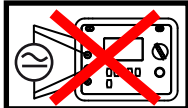

Ne pas utiliser sur des conducteurs susceptibles d'être reliés au réseau ou sur des conducteurs de terre non déconnectés.

Vérifier que le commutateur est en position OFF avant de brancher la prise secteur pour recharger la batterie de l'appareil.

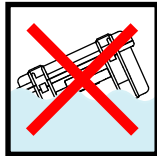
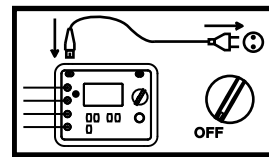

Ne pas immerger le microhmmètre C.A 6240.

Utiliser des accessoires de branchement dont la catégorie de surtension et la tension de service sont supérieures ou égales à celles de l'appareil de mesure (50V Cat III). N'utiliser que des accessoires conformes aux normes de sécurité (IEC 61010-2-031).

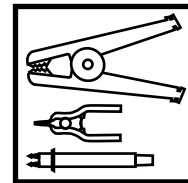

Toute procédure de dépannage ou de vérification métrologique doit être effectuée par du personnel compétent et agréé.

SOMMAIRE

1. PRÉSENTATION	6
2. CHARGE BATTERIE	8
3. MESURE DE RÉSISTANCE	9
3.1. Mesure de très faible valeur.....	10
3.2. Mesures répétitives	11
3.3. Messages d'erreur.....	11
4. MÉMORISATION DE RÉSULTATS	13
4.1. Mise en mémoire	13
4.2. Relecture mémoire	14
4.3. Effacement mémoire	14
4.4. Informations complémentaires	14
4.5. Enregistrement automatique.....	14
4.6. Transfert des données sur PC	15
5. AUTRES FONCTIONS (SET-UP)	16
5.1. Effacement complet de la mémoire.....	16
5.2. Programmation de l'heure.....	16
5.3. Programmation de la date.....	16
5.4. Programmation du temps d'arrêt automatique.....	17
5.5. Visualisation des paramètres internes de l'appareil	17
6. CARACTÉRISTIQUES	18
6.1. Conditions de référence.....	18
6.2. Caractéristiques des mesures de résistance.....	18
6.3. Caractéristiques des mesures de tension aux bornes de la résistance mesurée.....	18
6.4. Caractéristiques des mesures de courant circulant dans la résistance mesurée.....	19
6.5. Influences sur la mesure de résistance	19
6.6. Alimentation	19
6.7. Conditions d'environnement.....	20
6.8. Caractéristiques constructives	20
6.9. Conformité aux normes internationales	20
6.10. Compatibilité électromagnétique	20
7. MAINTENANCE	21
7.1. Entretien.....	21
7.2. Réparation	22
8. GARANTIE	22
9. POUR COMMANDER	22
9.1. Accessoires	22
9.2. Rechanges	22

1. PRÉSENTATION

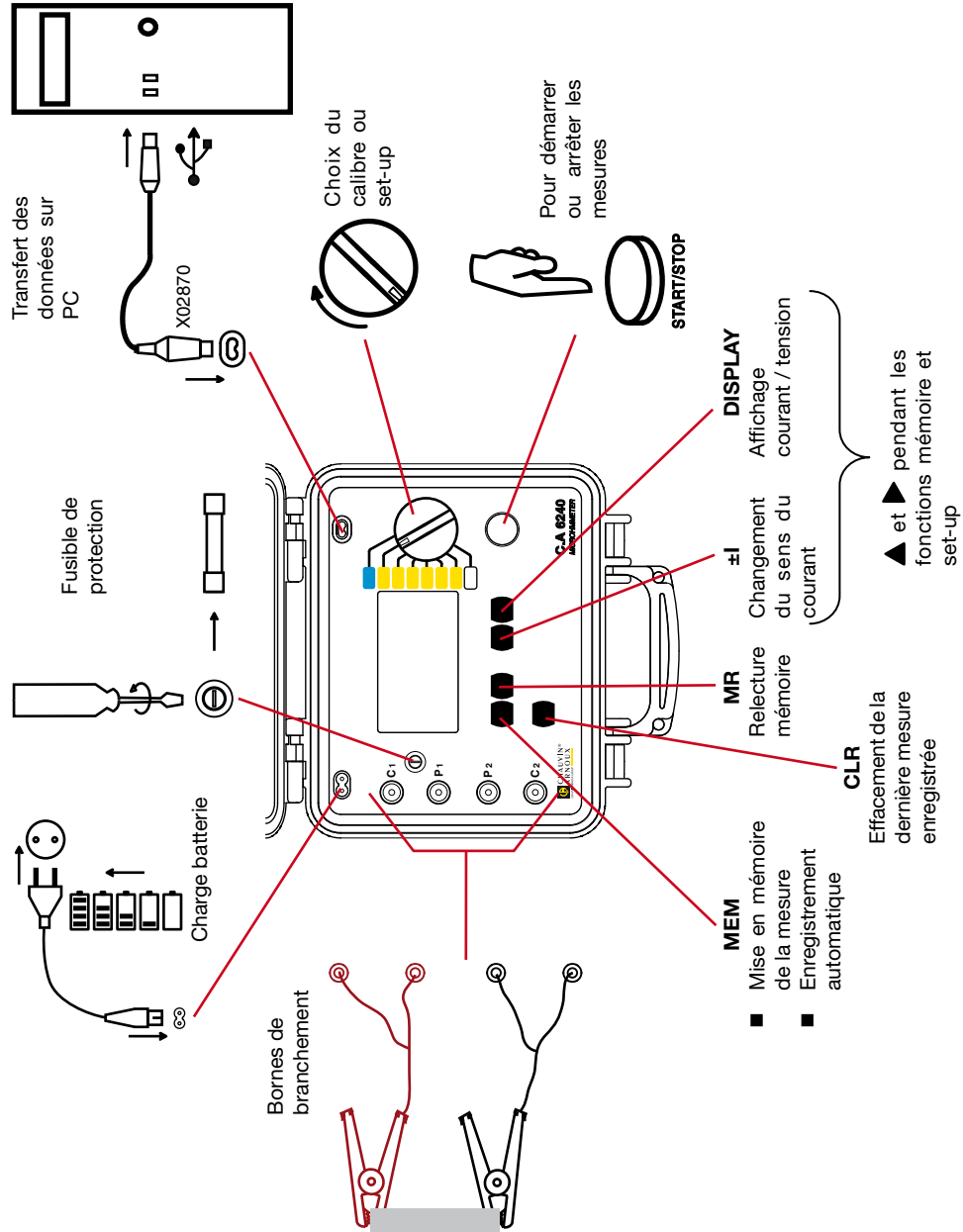

Le Microohmmètre C.A 6240 est un appareil de mesure portatif destiné à la mesure de très faibles valeurs de résistances. Il est présenté dans un boîtier chantier. Il est alimenté par une batterie rechargeable avec chargeur intégré.

- Fonction de mesure : résistance
- Mise en oeuvre : commutateur 8 positions, clavier 5 touches et 1 bouton START/STOP
- Affichage : afficheur LCD 100 x 57 mm, rétro-éclairé, comportant 2 niveaux d'affichage numérique simultanés

Représentation de l'afficheur

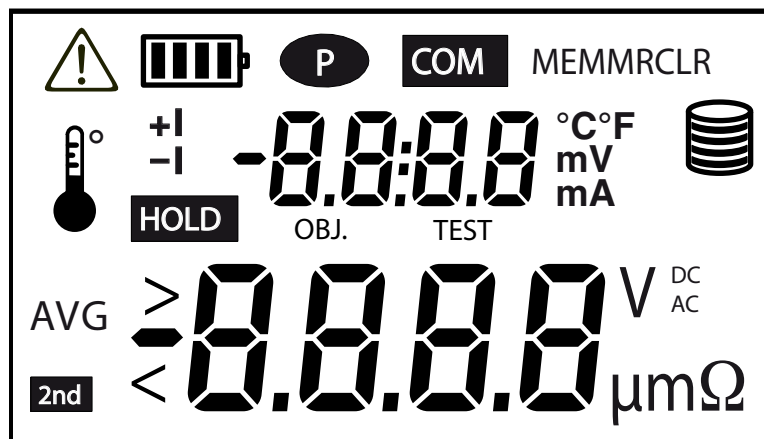

indique un clignotement

2. CHARGE BATTERIE

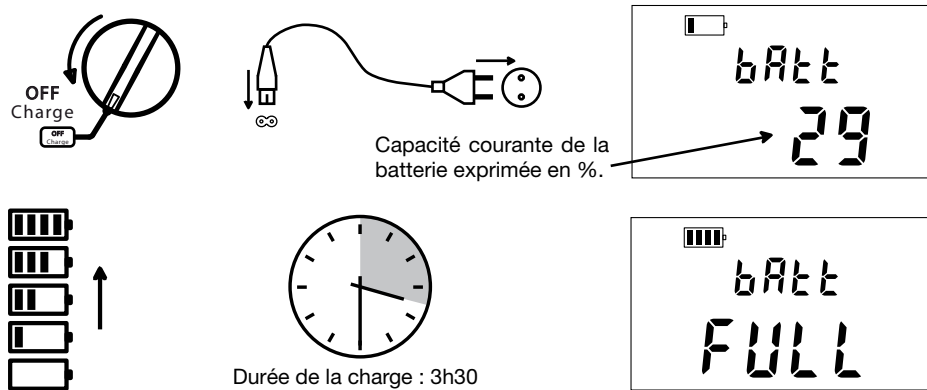

Commencer par charger complètement la batterie avant la première utilisation.
 Sur le calibre 10A, l'autonomie est de 1h20 environ. Il est donc préférable de charger la batterie avant d'entamer une campagne de mesures. La charge doit s'effectuer entre 0 et 40°C.
 L'autonomie de l'appareil dépend du calibre. Pour la visualiser (avant d'effectuer une mesure) :

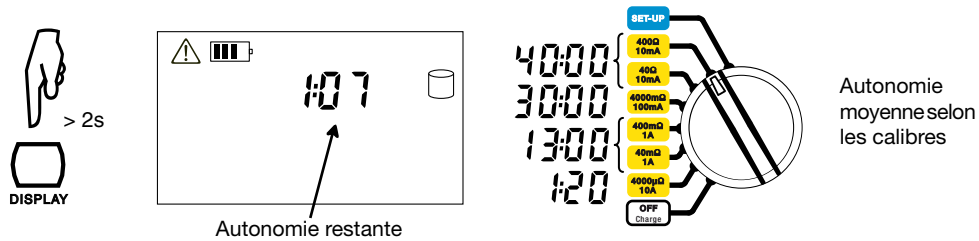

Suite à un stockage de longue durée, il se peut que la batterie soit complètement déchargée. Dans ce cas, la première charge peut durer plusieurs heures. La capacité de la batterie et donc l'autonomie de l'appareil seront temporairement moindres. La batterie retrouvera sa capacité initiale après 5 cycles de recharge.

3. MESURE DE RÉSISTANCE

1) Brancher les 2 câbles sur les 4 bornes de mesure, puis les 2 pinces Kelvin sur l'objet à tester. Ce dernier doit être hors tension.

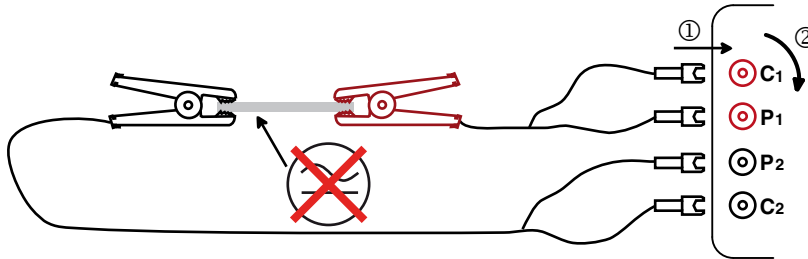

2) Placer le commutateur sur la position $400\Omega - 10\text{mA}$.

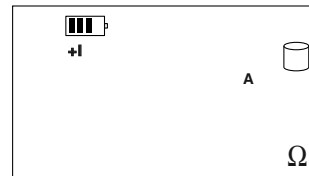
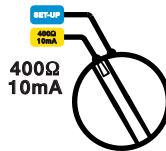

3) Démarrer la mesure en appuyant sur le bouton START/STOP.

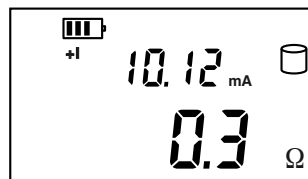

Si la mesure est trop faible, tourner alors le commutateur sur le calibre précédent, et relancer la mesure. Continuer tant que l'affichage ne se fait pas sur au moins 3 chiffres.

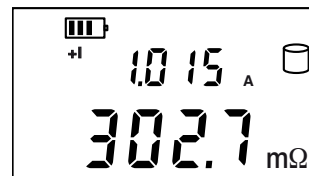
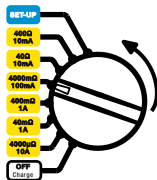

4) Appuyer à nouveau sur le bouton START/STOP pour arrêter la mesure ...

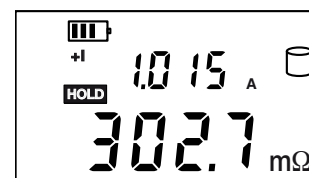

... ou débrancher une des 2 pinces.

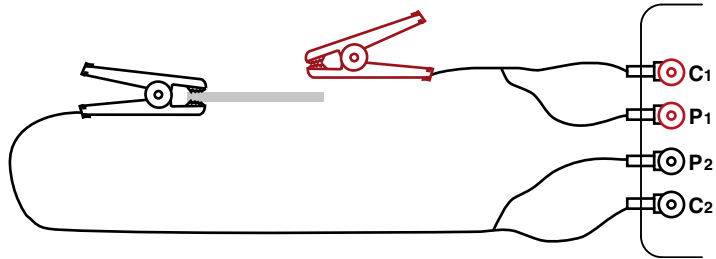

Dans les deux cas, la dernière mesure effectuée est affichée ainsi que le symbole **HOLD**

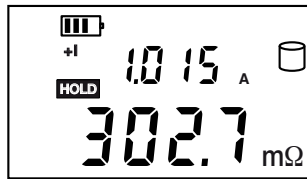

Si la mesure est arrêtée par le débranchement d'une pince, il suffit de les rebrancher sur un nouvel objet pour démarrer une nouvelle mesure, sans avoir à appuyer sur la touche START/STOP.

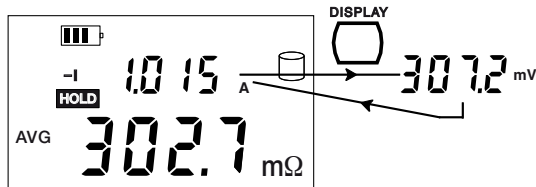

Pour afficher la tension aux bornes de la résistance au lieu du courant de mesure, appuyer sur la touche DISPLAY.

3.1. MESURE DE TRÈS FAIBLE VALEUR

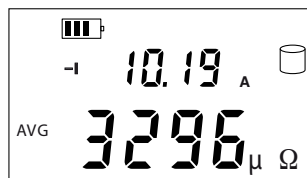
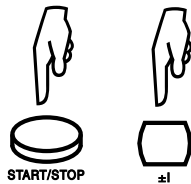

Inverser le sens du courant en appuyant sur la touche ± I, et l'appareil affiche la moyenne :

$$R_{AVG} = \frac{R(+I) + R(-I)}{2}$$

Cela permet de s'affranchir des effets des thermocouples.

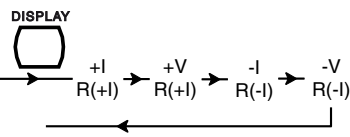
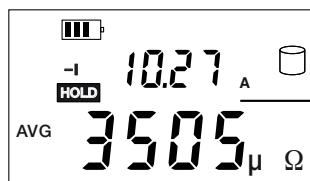

Pour visualiser les valeurs R(+I) et R(-I), appuyer sur la touche DISPLAY.

3.2. MESURES RÉPÉTITIVES

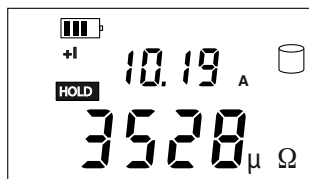
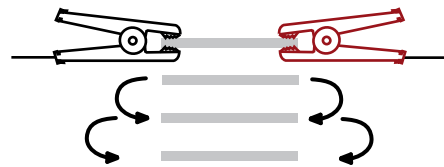
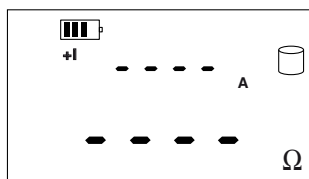
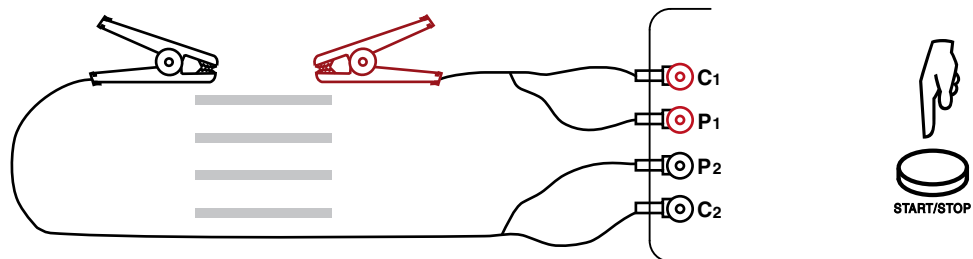

Brancher les pinces sur le premier objet à mesurer. La mesure démarre automatiquement. Retirer les pinces, la mesure s'arrête et le résultat s'affiche. Brancher les pinces sur le deuxième objet à mesurer. La mesure redémarre automatiquement. Et ainsi de suite. A la fin de la dernière mesure, appuyer à nouveau sur le bouton START/STOP.

3.3. MESSAGES D'ERREUR

3.3.1. PRÉSENCE D'UNE TENSION ⚠

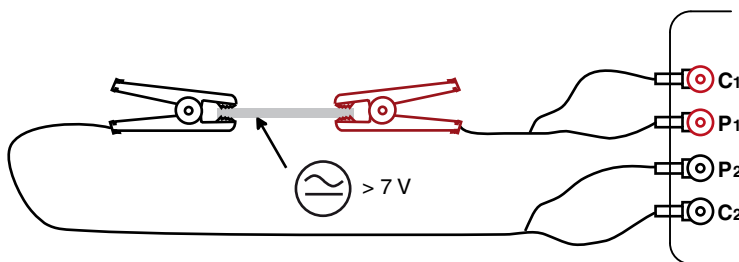

En cas de présence d'une tension externe sur le dispositif à mesurer, ...

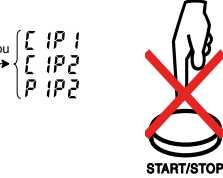
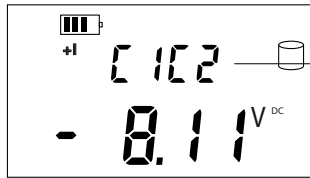

... l'appui sur le bouton START/STOP est sans effet, la mesure est impossible. Supprimer la tension pour effectuer la mesure.

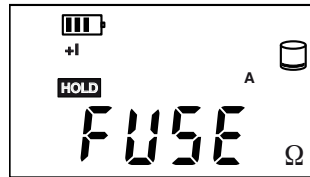
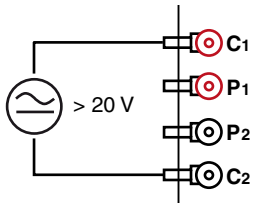

Si une tension supérieure à 20 V est appliquée entre les bornes C1 et C2, le fusible situé sur la face avant de l'appareil est détruit et il faut le remplacer (voir § 7.1.2)

3.3.2. DÉPASSEMENT DE CALIBRE



Si l'appareil indique un dépassement de calibre (symbole >), tourner alors le commutateur sur le calibre suivant, et relancer la mesure. Continuer tant que le message de dépassement de calibre s'affiche.

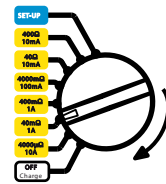

3.3.3. MESURE BRUITÉE

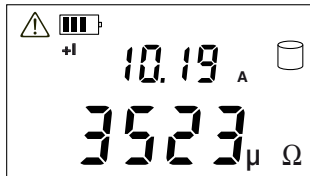

Le symbole  signale que la mesure est bruitée et que la précision de la mesure n'est pas garantie.

3.3.4 ECHAUFFEMENT EXCESSIF

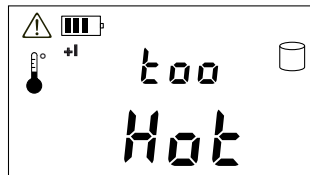

Si une mesure sur le calibre 10A dure plusieurs minutes, il se produit un échauffement interne trop important interdisant toute mesure. Il faut attendre que l'appareil refroidisse pour refaire des mesures.

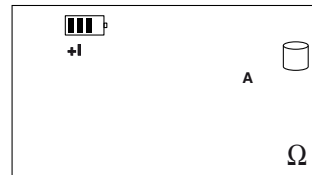

4. MÉMORISATION DE RÉSULTATS

Le stockage des données est organisé en objets (OBJ.), chacun pouvant contenir plusieurs tests (TEST). OBJ. correspond à l'objet testé et chaque test correspond à une mesure effectuée sur cet objet. L'appareil peut stocker 100 mesures.

4.1 MISE EN MÉMOIRE

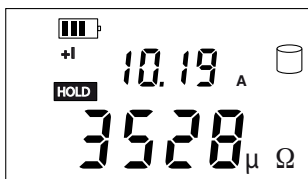

Une fois la mesure terminée, elle peut être enregistrée. Appuyer sur la touche MEM.



L'appareil propose la première case mémoire libre. Si elle convient, faites un appui long sur la touche MEM.

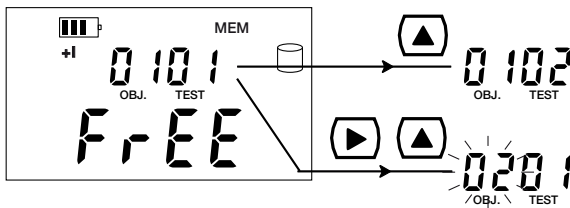
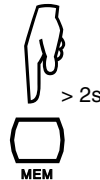

Pour modifier le numéro du test ou de l'objet, utiliser les flèches.

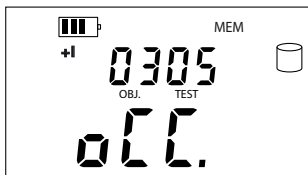

Si l'emplacement choisi est déjà occupé, l'appareil le signale. Mais il est possible de le remplacer par la nouvelle mesure.

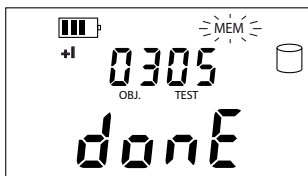
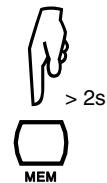

OU

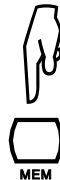

Pour sortir de la fonction sans rien enregistrer, appuyer sur la touche MEM.

4.2. RELECTURE MÉMOIRE

Il faut tout d'abord arrêter la mesure en appuyant sur le bouton START/STOP.

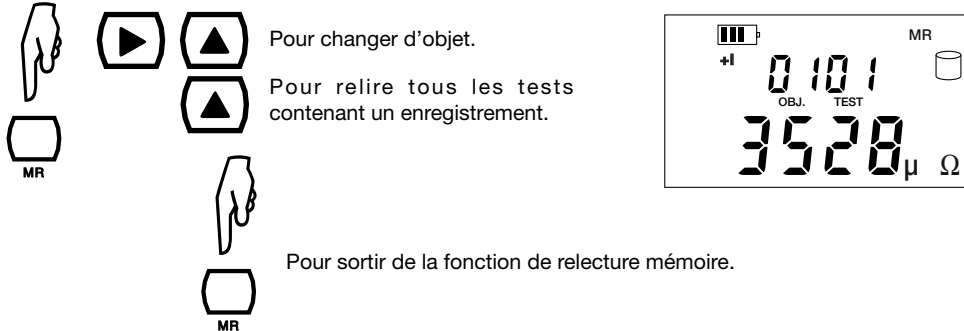

4.3. EFFACEMENT MÉMOIRE

Pour effacer un enregistrement (relecture mémoire ou non) :

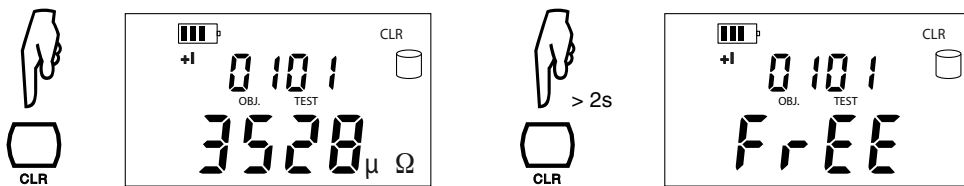

A l'aide des flèches, sélectionner le test à supprimer. L'effacement complet de la mémoire est décrit au § 5.1.

4.4. INFORMATIONS COMPLÉMENTAIRES



4.5. ENREGISTREMENT AUTOMATIQUE

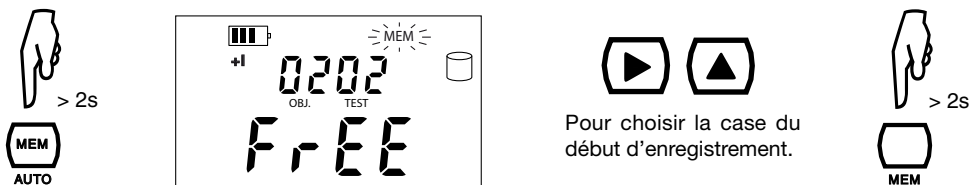

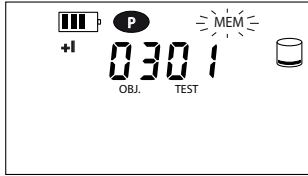

L'enregistrement automatique est activé.

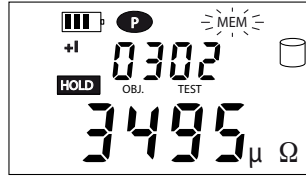

A chaque nouvelle mesure, le numéro du test est incrémenté et la mesure est enregistrée.

Pour arrêter l'enregistrement automatique, appuyer sur le bouton START/STOP.

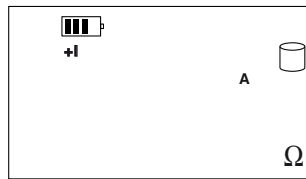

4.6. TRANSFERT DES DONNÉES SUR PC

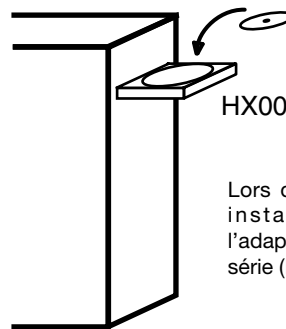
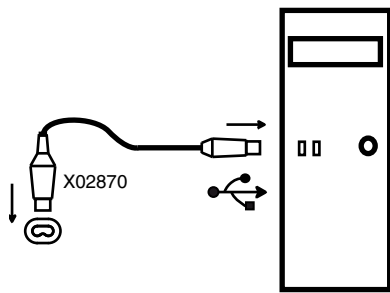

Lors du premier transfert, installer le driver de l'adaptateur USB / optique série (HX0056-Z).

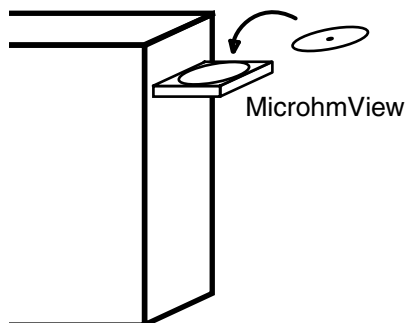

Puis, installer le logiciel d'application MicrohmView à l'aide du readme.txt.

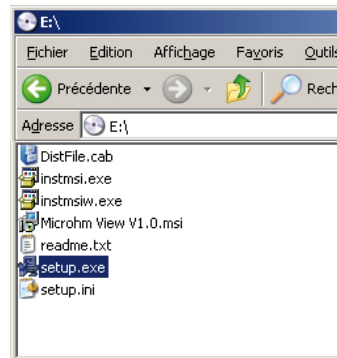

Pour utiliser Microhmview, se reporter à l'aide.

5. AUTRES FONCTIONS (SET-UP)

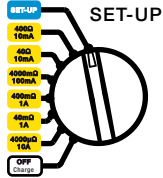

5.1. EFFACEMENT COMPLET DE LA MÉMOIRE

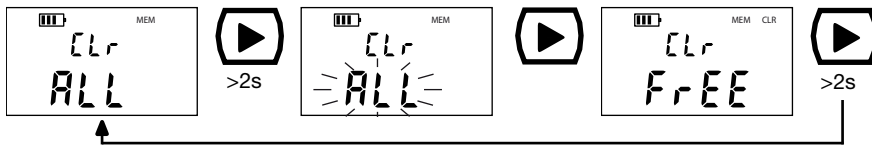

5.2. PROGRAMMATION DE L'HEURE



5.3. PROGRAMMATION DE LA DATE

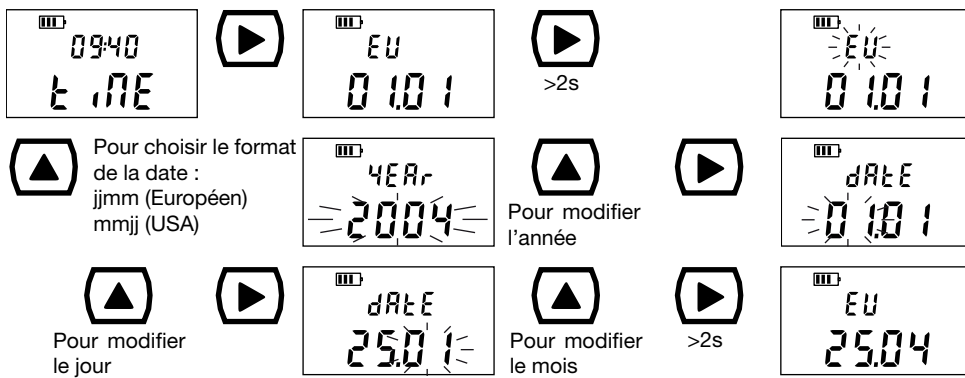

5.4. PROGRAMMATION DU TEMPS D'ARRÊT AUTOMATIQUE

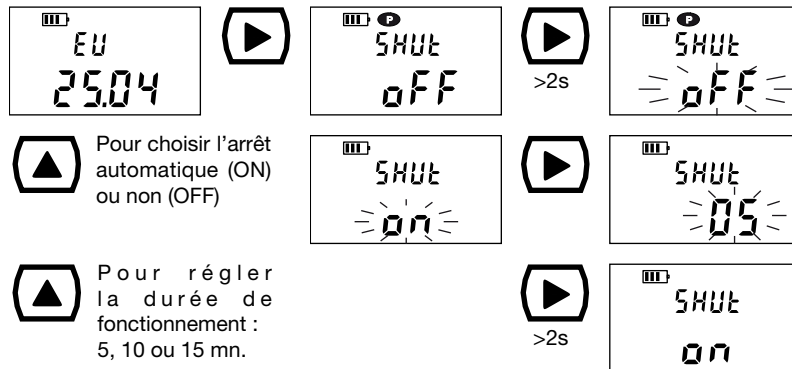

5.5. VISUALISATION DES PARAMÈTRES INTERNES DE L'APPAREIL

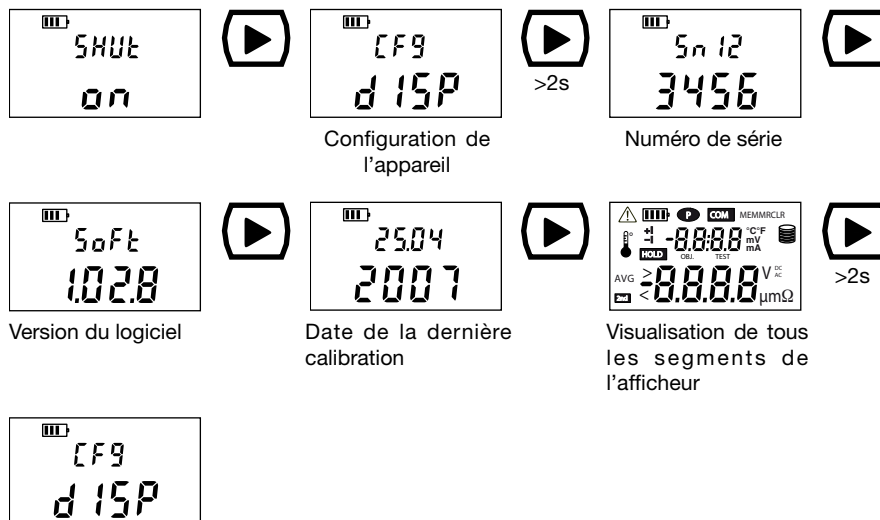

6. CARACTÉRISTIQUES

6.1. CONDITIONS DE RÉFÉRENCE

Grandeurs d'influence	Valeurs de référence
Température	23 ± 3 °C
Humidité relative	45 à 55 % HR
Tension d'alimentation	6 V ± 0,2 V
Tension externe présente aux bornes de la résistance sous test	nulle
Inductance de la résistance sous test	nulle
Champ électrique	nul
Champ magnétique	< 40 A/m

6.2. CARACTÉRISTIQUES DES MESURES DE RÉSISTANCE

Aucune tension ne doit être présente sur l'élément à mesurer.

Domaine de mesure	5 - 3999 $\mu\Omega$	4,00 - 39,99 m Ω	40,0 - 399,9 m Ω	400 - 3999 m Ω	4,00 - 39,99 Ω	40,0 - 399,9 Ω
Résolution	1 $\mu\Omega$	10 $\mu\Omega$	100 $\mu\Omega$	1 m Ω	10 m Ω	100 m Ω
Précision	± 0,25% ± 2 pt					
Courant de mesure	10,2 A ± 2% (1)	1,02 A ± 2%		102 mA ± 2%	10,2 mA ± 2% (2)	
Tension à vide	4 à 6 V					

(1) Avec une valeur nominale à 10,2 A, le courant de mesure minimal est de 10 A quelque soit l'état de la batterie.

(2) Le courant ne vaut 10 mA que jusqu'à 300 Ω . Si la batterie est faible, il peut baisser jusqu'à 8 mA.

6.3. CARACTÉRISTIQUES DES MESURES DE TENSION AUX BORNES DE LA RÉSISTANCE MESURÉE

Domaine de mesure	0,010 - 3,999 mV	4,00 - 39,99 mV	40,0 - 399,9 mV	0,400 - 3,999 V	4,00 - 4,70 V
Résolution	1 μ V	10 μ V	100 μ V	1 mV	10 mV
Précision	± 0,5% ± 10 pt		± 0,5% ± 1 pt		

6.4. CARACTÉRISTIQUES DES MESURES DE COURANT CIRCULANT DANS LA RÉSISTANCE MESURÉE

Domaine de mesure	5,00 – 39,99 mA	40,0 – 399,9 mA	0,400 – 3,999 A	4,00 – 11,00 A
Résolution	10 μ A	100 μ A	1 mA	10 mA
Précision	$\pm 0,5\% \pm 2$ pt	$\pm 0,5\% \pm 1$ pt		

6.5. INFLUENCES SUR LA MESURE DE RÉSISTANCE

Grandeurs d'influence	Limites du domaine d'utilisation	Variation de la mesure	
		Typique	Maximale
Température	-10 à + 55 °C	0,1 %/10 °C	0,5 %/10 °C + 2pt
Humidité relative	10 à 85 % HR @ 45°C	0,1 %	0,5 % + 2pt
Tension d'alimentation	5 à 7 V	2 pt	0,2%/ V + 2pt
Réjection de mode série 50/60 Hz (1)	$U (AC) = (R_{mesurée} \times I_{mesure})$	< 0,2%	2% + 1pt
Réjection de mode commun en AC 50/60 Hz	0 à 50 V AC	> 80 dB	> 60 dB

(1) Exemple : Si la résistance mesurée est de 1 m Ω et que le courant de mesure est de 10 A, une tension alternative de 1 mV eff en série avec la résistance à mesurer ne créera pas une erreur supérieure à 2%.

6.6. ALIMENTATION

L'alimentation de l'appareil est réalisée par un pack de batteries rechargeables à technologie NiMH 6V 8,5Ah. Cela vous permet de disposer de nombreux avantages :

- une grande autonomie pour un encombrement et un poids limité,
- la possibilité de recharger rapidement votre batterie,
- un effet mémoire très réduit : vous pouvez recharger rapidement votre batterie même si elle n'est pas complètement déchargée sans diminuer sa capacité,
- respect de l'environnement : absence de matériaux polluants comme le plomb ou le cadmium.

La technologie NiMH permet un nombre limité de cycle de charge/décharge qui dépend des conditions d'utilisation et des conditions de charge. Dans des conditions optimales, ce nombre de cycles est de 200.

L'appareil dispose de 2 modes de charges :

- une charge rapide : la batterie recouvre 90% de sa capacité en 3h;
- une charge d'entretien : ce mode apparaît lorsque la batterie est très faible et à la fin de la charge rapide.

L'autonomie est fonction des calibres utilisés

	Nombre de mesures (1)
Calibre 10 A	850
Calibre 1 A	3 500
Calibre 100 mA	4 500
Calibre 10 mA	5 000
Appareil en veille ou à l'arrêt	autonomie de 4 à 6 mois

(1) établi pour des mesures d'une durée de 5 s toutes les 25 s.

6.7. CONDITIONS D'ENVIRONNEMENT

Utilisation en intérieur et en extérieur.

Domaine d'utilisation	- 10 à +55 °C	10 à 85 %HR
Stockage (sans batterie)	- 40 à +70 °C	10 à 90 %HR
Altitude	< 2000 m	
Degré de pollution	2	

Pour un stockage de longue durée (2 ans) avec la batterie, il ne faut pas sortir de la plage -20 à +30 °C et 85 %HR sinon, les caractéristiques de la batterie se détériorent. Pour un stockage de courte durée (1 mois), la température peut monter jusqu'à 50 °C.

6.8. CARACTÉRISTIQUES CONSTRUCTIVES

Dimensions hors tout de l'appareil (L x l x h) : 273 x 247 x 176 mm

Masse : 4,5 kg environ

IP 53 selon NF EN 60529 (Ed. 92)

IK 04 selon NF EN 50102 (Ed. 95)

6.9. CONFORMITÉ AUX NORMES INTERNATIONALES

Sécurité électrique selon EN 61010-1 (Ed. 2 de 2001).

Mesure selon EN 61557 (Ed. 2 de 2007) parties 1 et 4.

Caractéristiques assignées : catégorie de mesure III, 50 V par rapport à la terre, 500 V en différentiel entre les bornes et 300 V cat II sur l'entrée chargeur

6.10. COMPATIBILITÉ ÉLECTROMAGNÉTIQUE

L'appareil répond aux directives CEM et DBT nécessaires au marquage CE et à la norme produit EN 61326-1 (Ed. 97) + A1 (Ed. 98)

- Emission en milieu résidentiel
- Immunité en milieu industriel

7. MAINTENANCE

⚠ Pour la maintenance, utilisez seulement les pièces de rechange qui ont été spécifiées. Le fabricant ne pourra être tenu pour responsable de tout accident survenu suite à une réparation effectuée en dehors de son service après-vente ou des réparateurs agréés.

7.1. ENTRETIEN

7.1.1. RECHARGE DE LA BATTERIE



⚠ Le remplacement de la batterie devra être effectué par Manumasure ou un réparateur agréé par CHAUVIN ARNOUX. Ne monter que la batterie préconisée par le constructeur. Le changement de batterie n'entraîne pas la perte des données en mémoire. Par contre, il faut reprogrammer la date et l'heure (voir § 5.2 et 5.3).

7.1.2. REMPLACEMENT DU FUSIBLE

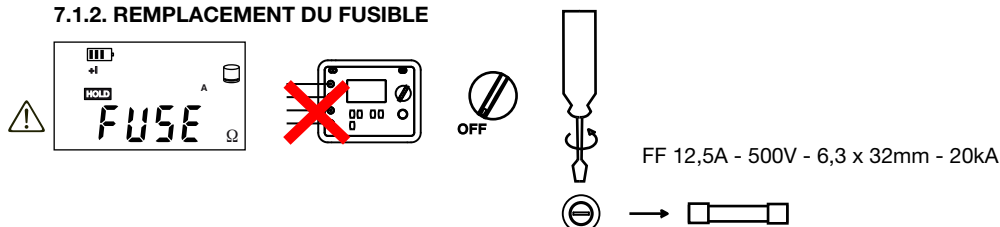

7.1.3. NETTOYAGE

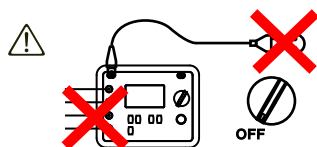

Utiliser un chiffon doux, légèrement imbibé d'eau savonneuse. Rincer avec un chiffon humide et sécher rapidement avec un chiffon sec ou de l'air pulsé. Ne pas utiliser d'alcool, de solvant ou d'hydrocarbure.

7.1.4. VÉRIFICATION MÉTROLOGIQUE

Comme tous les appareils de mesure ou d'essais, une vérification périodique est nécessaire.

Nous vous conseillons au moins une vérification annuelle de cet appareil. Pour les vérifications et étalonnages, adressez-vous à nos laboratoires de métrologie accrédités COFRAC ou aux agences MANUMESURE.

Renseignements et coordonnées sur demande :

Tél. : 02 31 64 51 43 - Fax : 02 31 64 51 09

7.1.5. MISE À NIVEAU DU LOGICIEL DE L'APPAREIL

Dans un souci constant de fournir le meilleur service rendu en termes de performances et d'évolution technique, CHAUVIN ARNOUX vous offre la possibilité de mettre à jour le logiciel intégré à l'appareil (firmware) en téléchargeant gratuitement la nouvelle version disponible sur notre site internet.

Pour plus d'information, veuillez consulter notre site <http://www.chauvin-arnoux.com> à la rubrique «Espace Support Logiciel».

7.2. RÉPARATION

Pour les réparations sous garantie et hors garantie, adressez votre appareil à l'une des agences régionales MANUMESURE, agréées CHAUVIN ARNOUX

Renseignements et coordonnées sur demande :

Tél. : 02 31 64 51 43 - Fax : 02 31 64 51 09

Pour les réparations hors de France métropolitaine, sous garantie et hors garantie, retournez l'appareil à votre distributeur.

8. GARANTIE

Notre garantie s'exerce, sauf stipulation expresse, pendant **douze mois** après la date de mise à disposition du matériel. Extrait de nos Conditions Générales de Vente, communiquées sur demande.

9. POUR COMMANDER

C.A 6240 P01.1432.00

Le C.A 6240 est livré dans une boîte en carton avec une sacoche de transport d'accessoires contenant :

un jeu de 2 pinces Kelvin 10A avec câble de 3m,

un cordon d'alimentation secteur de 2m,

un câble de communication optique / USB,

le logiciel « Microhmview »,

5 notices de fonctionnement simplifiées,

et cette notice de fonctionnement 5 langues.

9.1. ACCESSOIRES

cordon d'alimentation secteur GB de 2m P01.2952.53

jeu de 2 pointes de touche doubles P01.1017.82

jeu de 2 mini-pinces Kelvin P01.1017.83

thermo-hygromètre C.A 846 P01.1563.01Z

câble de communication optique / RS P01.2952.52

9.2. RECHANGES

lot de 10 fusible FF 12,5A - 500V - 6,3x32mm P01.2970.91

jeu de 2 pinces Kelvin 10A avec câble de 3m P01.1017.94

cordon d'alimentation secteur 2P EURO de 2m P01.2951.74

sac de transport standard P01.2980.66

câble de communication optique / USB HX0056-Z

ENGLISH

 **WARNING, risk of DANGER !** Refer to the operating manual.
Failure to perform the instructions in this operating manual preceded by this symbol, or to perform them correctly, may cause bodily injury or damage to the instrument and the installations.

 Equipment protected throughout by double or reinforced insulation.

 The crossed-out trash can means that, in the European Union, the product, when disposed of, must be sorted for the recycling of electrical and electronic equipment in accordance with WEEE directive 2002/96/EC.

 Earth terminal.

Definition of measurement categories:

- Measurement category III corresponds to measurements on building installations.
- Measurement category IV corresponds to measurements taken on circuits directly connected to low-voltage installations.
- Measurement category I corresponds to measurements taken on circuits not directly connected to the network.

Thank you for buying a **C.A 6240 microhmmeter**.

For best results:

- read this operating manual carefully
- observe the precautions for use

Attach one of the 5 specifications labels, with your appropriate language, on the inside of the lid.

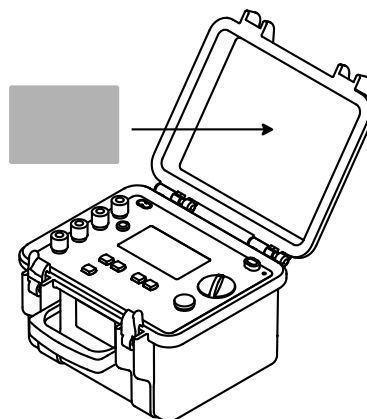

⚠ PRECAUTIONS FOR USE ⚠

This instrument is protected from accidental voltages of not more than 50V with respect to earth in measurement category III. The guaranteed level of protection of this equipment may be compromised if used in a manner not specified by the manufacturer.

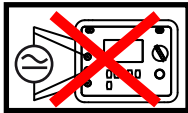

Do not use on conductors likely to be connected to line power or on earth conductors that are not disconnected.

Check that the switch is set to OFF before plugging in the mains cord to recharge the battery of the instrument.

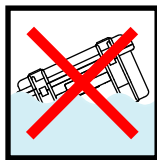
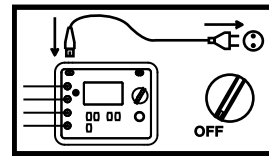

Do not immerse the C.A 6240 microhmmeter in water.

Use connection accessories which have an overvoltage category and service voltage greater than or equal to those of the measuring instrument (50 V Cat III). Use only accessories that comply with safety standards (IEC 61010-2-031).

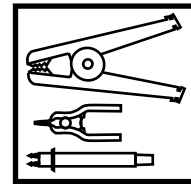

All troubleshooting and metrological checks must be performed by competent and accredited personnel.

CONTENTS

1. PRESENTATION	26
2. BATTERY CHARGE	28
3. RESISTANCE MEASUREMENT	29
3.1. Measurement of a very low value	30
3.2. Repetitive measurements	31
3.3. Error messages	31
4. STORAGE OF RESULTS	33
4.1. Storing	33
4.2. Read memory	34
4.3. Erase memory	34
4.4. Further information	34
4.5. Automatic recording	34
4.6. Transfer of data to PC	35
5. OTHER FUNCTIONS (SET-UP)	36
5.1. Complete erasure of memory	36
5.2. Programming the time	36
5.3. Programming the date	36
5.4. Programming of automatic stopping time	37
5.5. Displaying the internal parameters of the instrument	37
6. CHARACTERISTICS	38
6.1. Reference conditions	38
6.2. Characteristics of the resistance measurements	38
6.3. Characteristics of the voltage measurements on the terminals of the resistance measured	38
6.4. Characteristics of the measurements of the current flowing in the resistance measured	39
6.5. Influences on the resistance measurement	39
6.6. Power supply	39
6.7. Environmental conditions	40
6.8. Characteristics of construction	40
6.9. Conformity to international standards	40
6.10. Electromagnetic compatibility	40
7. MAINTENANCE	41
7.1. Servicing	41
7.2. Repair	41
8. WARRANTY	42
9. TO ORDER	42
9.1. Accessories	42
9.2. Spares	42

1. PRESENTATION

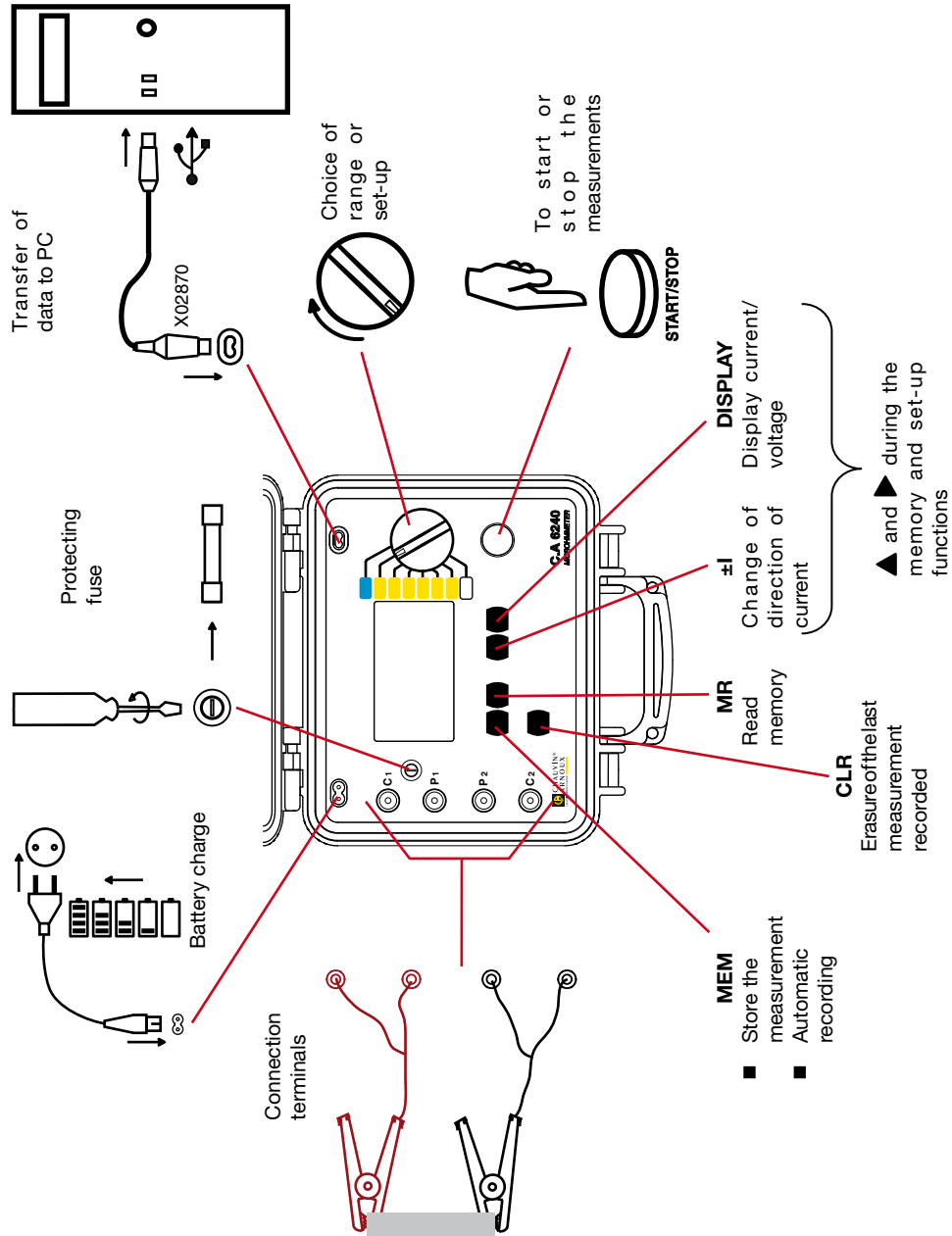

The C.A 6240 Microhmmeter is a portable measuring instrument intended for the measurement of very low resistance values. It is enclosed in a site case and powered by a rechargeable battery with a built-in charger.

- Measurement functions : resistance
- Controls : 8-position switch, 5-key keypad, and 1 START/STOP button
- Display : LCD display unit, 100 x 57 mm, back-lit, having 2 simultaneous digital display levels

Representation of the display

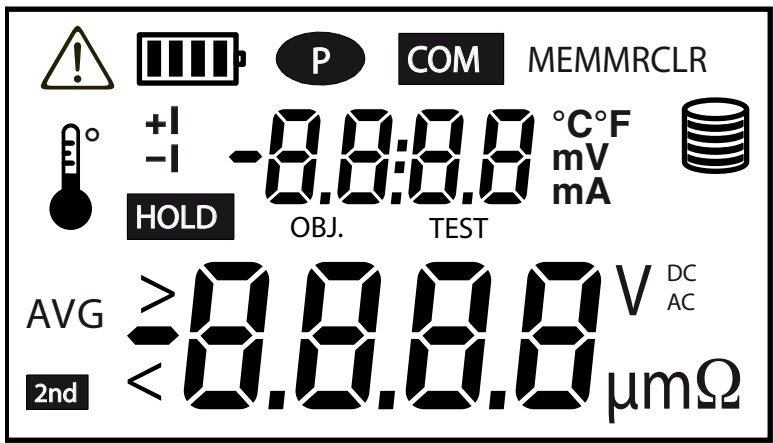

 indicates flashing

2. BATTERY CHARGE

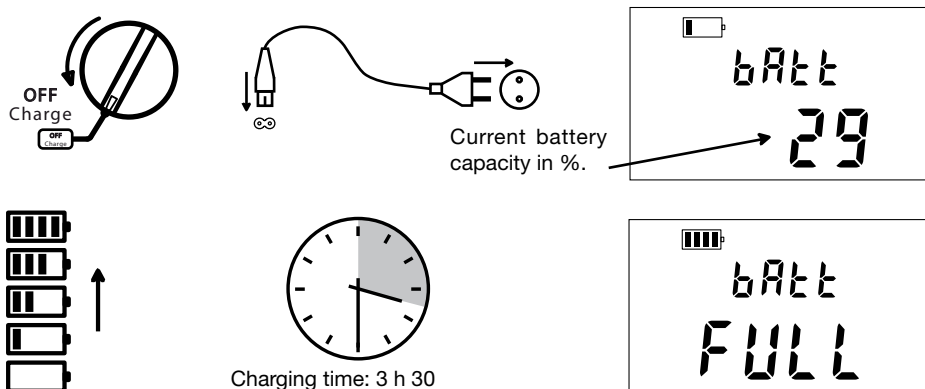

Start by fully charging the battery before the first use.

In the 10 A range, the battery life is approximately 1h20. It is therefore best to charge the battery before starting series of measurements. Charging must be done between 0 and 40°C.

The battery life of the instrument depends on the range. To display it (before making the measurement):

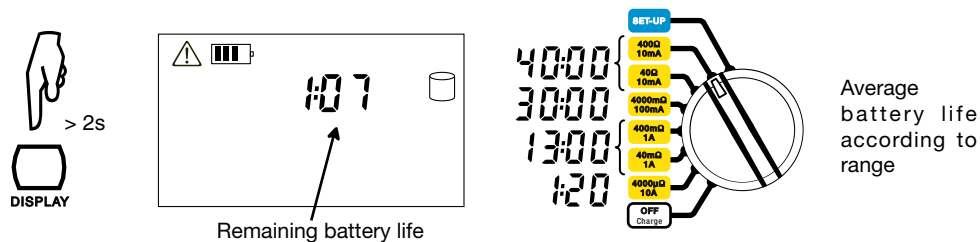

Following long-term storage, the battery may be completely discharged. In this case, the first charge may last several hours. The capacity of the battery and therefore the battery life of the instrument will be temporarily reduced. The battery will recover its initial capacity after 5 recharging cycles.

3. RESISTANCE MEASUREMENT

1) Connect the 2 cables to the 4 measurement terminals, then the 2 Kelvin clips to the object to be tested, which must not be live.

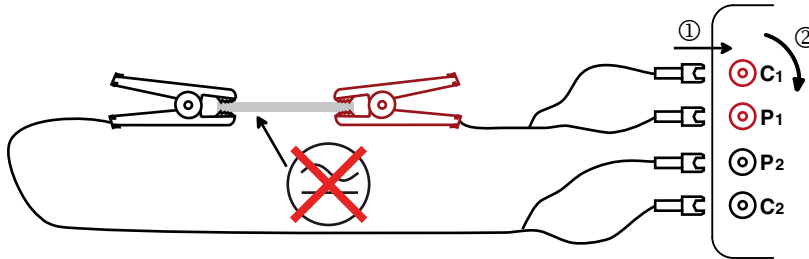

2) Set the switch to 400Ω - 10 mA.

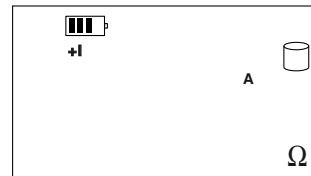
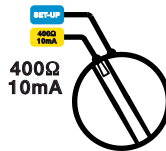

3) Start the measurement by pressing the START/STOP button.

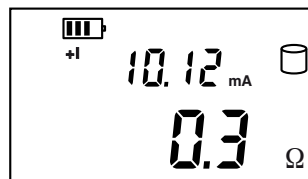

If the measurement is too low, turn the switch to the next lower range and restart the measurement. Continue until the display shows at least 3 digits.

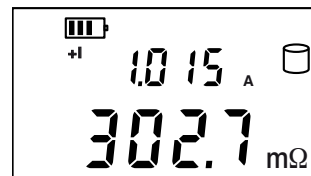
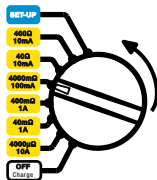

4) Press the START/STOP button again to stop the measurement...

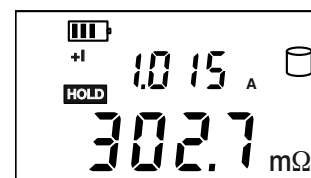

...or disconnect one of the 2 clips.

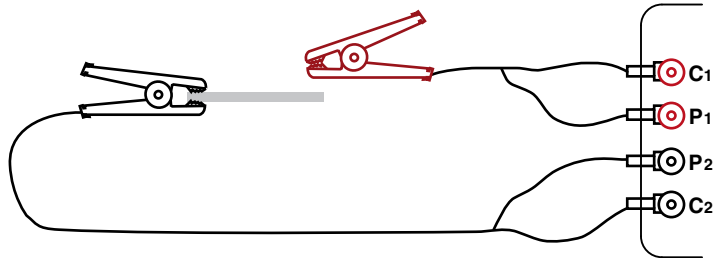

In both cases, the last measurement made is displayed, along with the **HOLD** symbol.

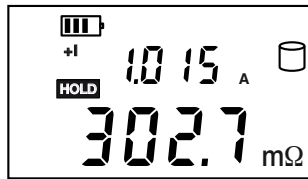

If the measurement is stopped by the disconnection of a clip, simply connecting it to another object starts another measurement, with no need to press the START/STOP key.

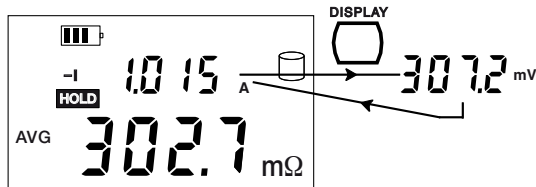

To display the voltage on the terminals of the resistance instead of the measurement current, press the DISPLAY key.

3.1. MEASUREMENT OF A VERY LOW VALUE

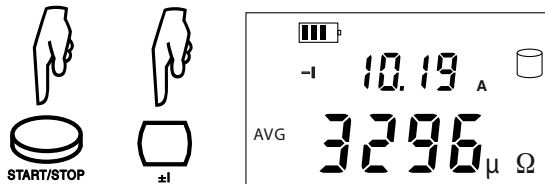

Reverse the direction of the current by pressing the $\pm I$ key and the instrument displays the average:

$$R_{AVG} = \frac{R(+I) + R(-I)}{2}$$

This serves to eliminate any thermoelectric effect.

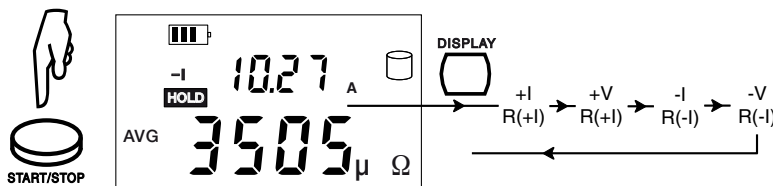

To display the values $R(+I)$ and $R(-I)$, press the DISPLAY key.

3.2. REPETITIVE MEASUREMENTS

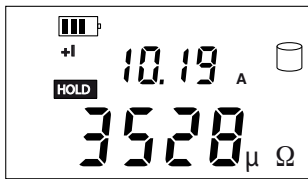
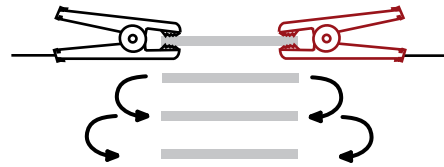
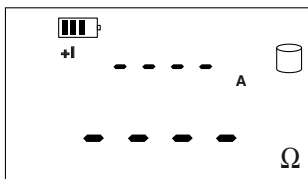
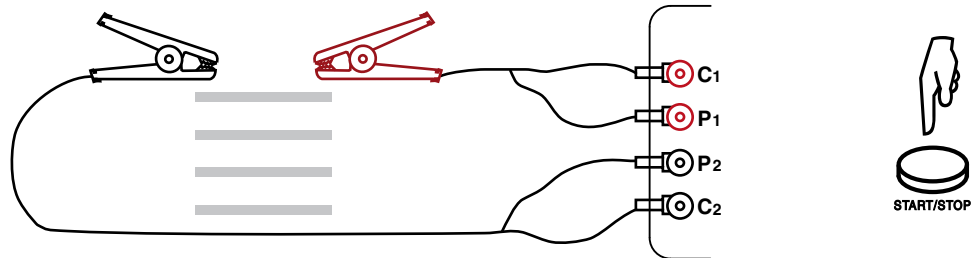

Connect the clips to the first object to be measured. The measurement starts automatically. Withdraw the clips: the measurement stops and the result is displayed. Connect the clips to the second object to be measured. The measurement restarts automatically. And so on. After the last measurement, press the START/STOP button again.

3.3. ERROR MESSAGES

3.3.1. PRESENCE OF A VOLTAGE ⚠

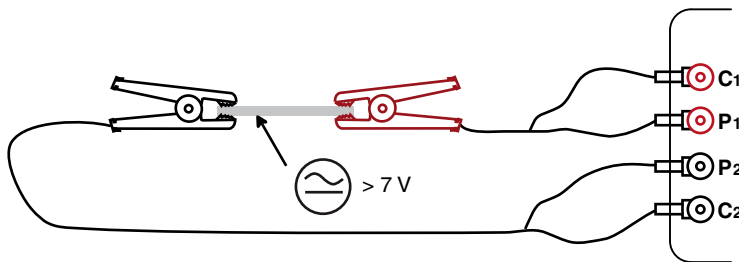

If there is an external voltage on the device to be measured...

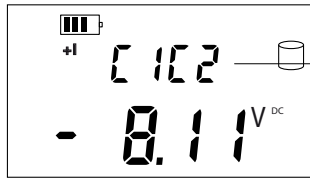

...pressing the START/STOP button has no effect: the measurement is impossible. Remove the voltage to make the measurement.

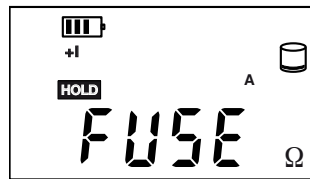
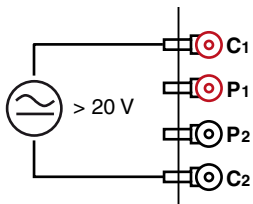

If a voltage greater than 20 V is applied between terminals C1 and C2, the fuse on the front panel of the instrument will blow and must be replaced (see §7.1.2)

3.3.2. RANGE OVERTHOOT

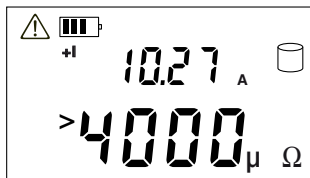

If the instrument indicates a range overshoot (> symbol), turn the switch to the next higher range and restart the measurement. Continue for as long as the range overshoot message is displayed.

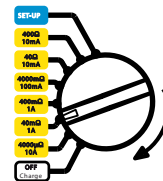

3.3.3. NOISY MEASUREMENT

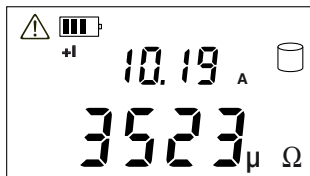

The  symbol indicates that the measurement is noisy and that its accuracy is not guaranteed.

3.3.4 OVERHEATING

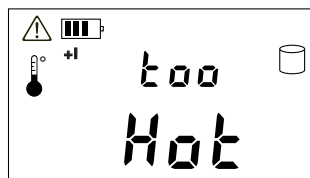

If a measurement in the 10 A range lasts several minutes, it causes internal overheating, making all measurements impossible. It is then necessary to wait for the instrument to cool before resuming the measurements.

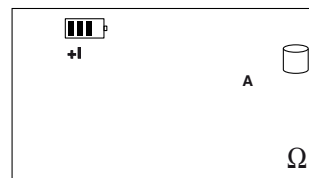

4. STORAGE OF RESULTS

Data storage is organised into objects (OBJ.), each of which can contain several tests (TEST). OBJ. corresponds to the object tested and each test corresponds to a measurement made on the object. The instrument can store 100 measurements.

4.1 STORING

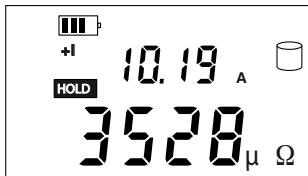

Once the measurement is over, it can be recorded. Press the MEM key.



The instrument proposes the first free location in memory. If it is acceptable, execute a long press on the MEM key.

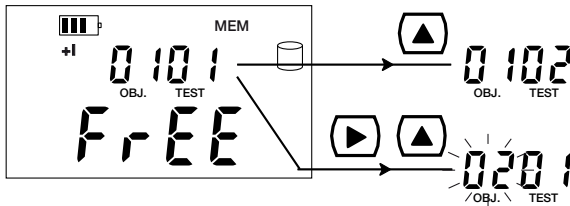
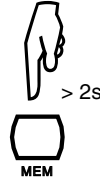

To change the number of the test or of the object, use the arrows.

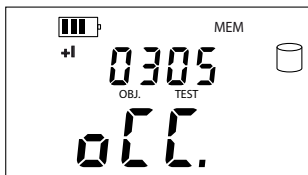

If the location chosen is already occupied, the instrument so indicates. But it is possible to overwrite the old measurement with the new one.

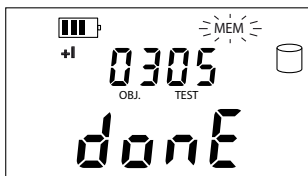
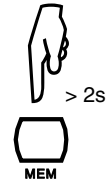

or

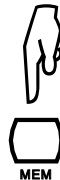

To exit from the function without recording anything, press the MEM key.

4.2. READ MEMORY

It is necessary first of all to stop the measurement by pressing the START/STOP button.

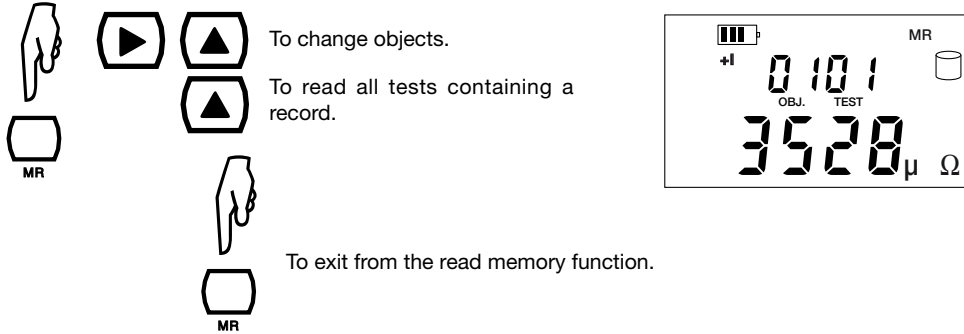

4.3. ERASE MEMORY

To erase a record (read memory or not):

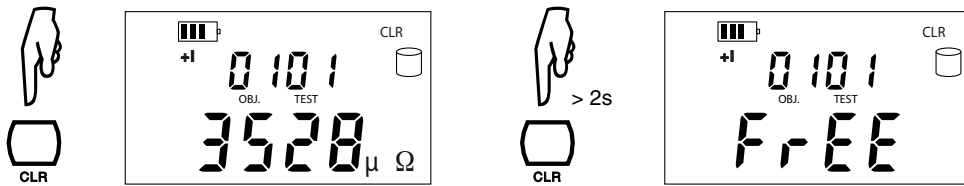

4.4. FURTHER INFORMATION

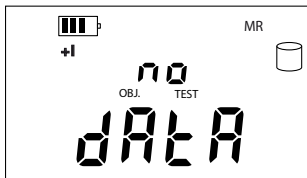

Memory empty

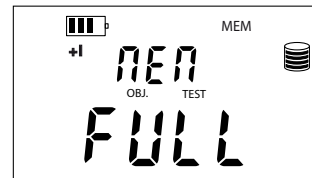

Memory full

4.5. AUTOMATIC RECORDING

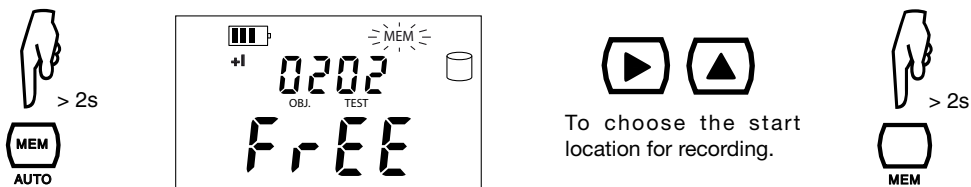

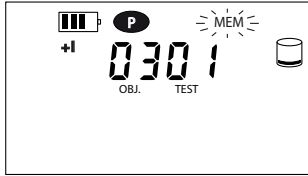

Automatic recording activated.

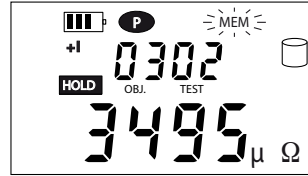

At each new measurement, the test number is incremented and the measurement is recorded.

To stop automatic recording, press the START/STOP button.

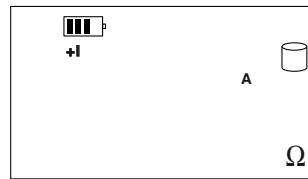

4.6. TRANSFER OF DATA TO PC

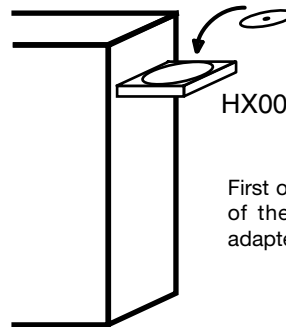
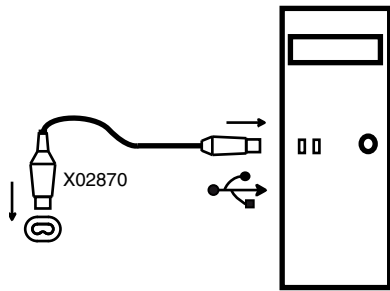

HX0056-Z

First of all, install the driver of the USB/serial optical adapter (HX0056-Z).

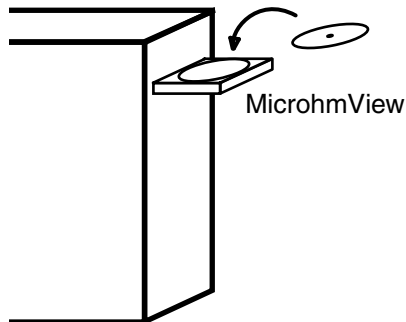

Then install the MicrohmView application software as explained in readme.txt.

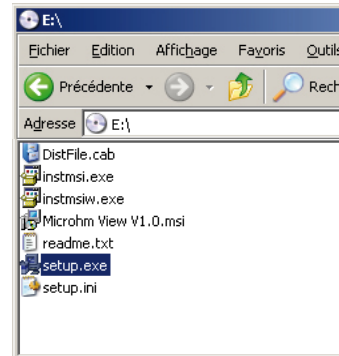

To use Microhmview, refer to the help function.

5. OTHER FUNCTIONS (SET-UP)

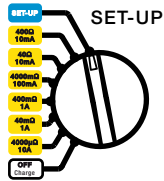

5.1. COMPLETE ERASURE OF MEMORY

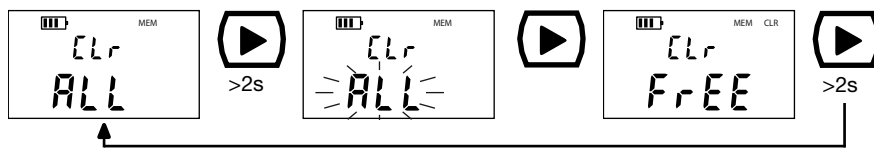

5.2. PROGRAMMING THE TIME



5.3. PROGRAMMING THE DATE

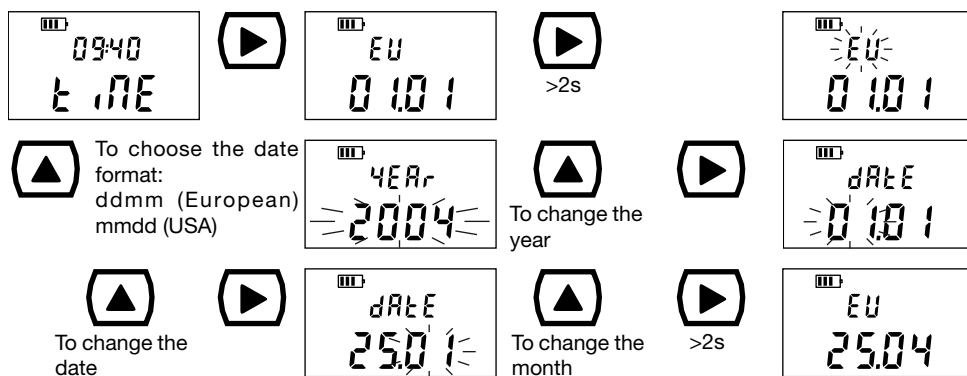

6. CHARACTERISTICS

6.1. REFERENCE CONDITIONS

Quantities of influence	Reference values
Temperature	23 ± 3 °C
Relative humidity	45 to 55 % RH
Supply voltage	6 V ± 0,2 V
External voltage present on the terminals of the resistance being tested	zero
Inductance of the resistance being tested	zero
Electric field	zero
Magnetic field	< 40 A/m

6.2. CHARACTERISTICS OF THE RESISTANCE MEASUREMENTS

There must be no voltage on the element to be measured.

Measurement range	5 - 3999 μΩ	4,00 - 39,99 mΩ	40,0 - 399,9 mΩ	400 - 3999 mΩ	4,00 - 39,99 Ω	40,0 - 399,9 Ω
Resolution	1 μΩ	10 μΩ	100 μΩ	1 mΩ	10 mΩ	100 mΩ
Accuracy	± 0,25% ± 2 pt					
Measurement current	10,2 A ± 2% (1)	1,02 A ± 2%		102 mA ± 2%	10,2 mA ± 2% (2)	
No-load voltage	4 to 6 V					

(1) With a nominal value of 10.2 A, the measurement current is at least 10 A whatever the charge condition of the battery.

(2) The current is 10 mA only up to 300 Ω. If the battery is low, it can fall to as low as 8 mA.

6.3. CHARACTERISTICS OF THE VOLTAGE MEASUREMENTS ON THE TERMINALS OF THE RESISTANCE MEASURED

Measurement range	0,010 - 3,999 mV	4,00 - 39,99 mV	40,0 - 399,9 mV	0,400 - 3,999 V	4,00 - 4,70 V
Resolution	1 μV	10 μV	100 μV	1 mV	10 mV
Accuracy	± 0,5% ± 10 pt		± 0,5% ± 1 pt		

6.4. CHARACTERISTICS OF THE MEASUREMENTS OF THE CURRENT FLOWING IN THE RESISTANCE MEASURED

Measurement range	5,00 – 39,99 mA	40,0 – 399,9 mA	0,400 – 3,999 A	4,00 – 11,00 A
Resolution	10 μ A	100 μ A	1 mA	10 mA
Accuracy	$\pm 0,5\% \pm 2$ pt	$\pm 0,5\% \pm 1$ pt		

6.5. INFLUENCES ON THE RESISTANCE MEASUREMENT

Quantities of influence	Range of use	Variation of the measurement	
		Typical	Maximum
Temperature	-10 to + 55 °C	0,1 %/10 °C	0,5 %/10 °C + 2pt
Relative humidity	10 to 85 % RH @ 45°C	0,1 %	0,5 % + 2pt
Supply voltage	5 to 7 V	2 pt	0,2%/ V + 2pt
Series mode rejection, 50/60 Hz (1)	$U (AC) = (R_{measured} \times I \text{ measurement})$	< 0,2%	2% + 1pt
Common mode rejection, 50/60 Hz AC	0 to 50 V AC	> 80 dB	> 60 dB

(1) Example: If the measured resistance is 1 m Ω and the measurement current is 10 A, an alternating voltage of 1 mV RMS in series with the resistance to be measured will induce an error of not more than 2%.

6.6. POWER SUPPLY

The instrument is powered by a rechargeable 6 V 8.5Ah NiMH battery pack. This has many advantages :

- long life with small size and weight,
- the possibility of recharging your battery rapidly,
- a very small memory effect: you can recharge your battery rapidly, even if it is not fully discharged, without reducing its capacity,
- protection of the environment: no polluting materials such as lead or cadmium.

The NiMH technology allows a limited number of charging/discharging cycles. The number depends on the conditions of use and on the charging conditions. Under optimum conditions, the number of cycles is 200.

The instrument has 2 charging modes:

- rapid charging: the battery recovers 90% of its capacity in 3h;
- maintenance charging: this mode cuts in when the battery is very low and at the end of rapid charging.

The battery life depends on the ranges used

	Number of measurements (1)
10 A range	850
1 A range	3 500
100 mA range	4 500
10 mA range	5 000
Instrument on standby or off	battery life 4 to 6 months

(1) established for measurements lasting 5s, every 25s.

6.7. ENVIRONMENTAL CONDITIONS

Use indoors or outdoors.

Range of use	- 10 to +55 °C	10 to 85 % RH
Storage (without battery)	- 40 to +70 °C	10 to 90 % RH
Altitude	< 2000 m	
Degree of pollution	2	

For long-term storage (2 years) with the battery, conditions must not depart from the range -20 to +30°C and 85% RH; otherwise, the battery life will be degraded. For short-term storage (1 month), the temperature can reach 50°C.

6.8. CHARACTERISTICS OF CONSTRUCTION

Overall dimensions of the instruments (L x W x H): 273 x 247 x 176 mm

Mass: approximately 4.5 kg

IP 53 per NF EN 60529 (Ed. 92)

IK 04 per NF EN 50102 (Ed. 95)

6.9. CONFORMITY TO INTERNATIONAL STANDARDS

Electrical safety as per EN 61010-1 (Ed. 2 of 2001)

Measurement according to EN 61557 (Ed. 2 of 2007) parts 1 and 4.

Safety level categories: measurement category III, 50V with respect to earth, 500V differential between terminals, and 300V cat II on the charger input

6.10. ELECTROMAGNETIC COMPATIBILITY

The instrument satisfies the CEM and DBT directives required for the CE marking and product standard

EN 61326-1 (Ed. 97) + A1 (Ed. 98)

- Emissions in residential environment
- Immunity in industrial environment

7. MAINTENANCE

 For maintenance, use only the spare parts specified. The manufacturer cannot be held liable for any accident that occurs following a repair not performed by its customer service department or by an approved repairer.



7.1. SERVICING

7.1.1. RECHARGING THE BATTERY

 → Recharge the battery (see §2)

 The battery must be replaced by Manumasure or by a repairer approved by Chauvin Arnoux. Only fit the battery recommended by the manufacturer. Replacing the battery does not cause a loss of the data in memory. However, the date and time must be reprogrammed (see § 5.2 and 5.3).

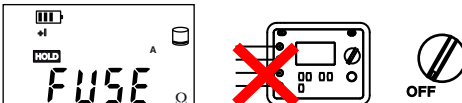
7.1.2. REPLACEMENT OF THE FUSE

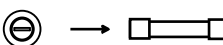
   FF 12,5 A - 500 V - 6,3 x 32 mm - 20 kA

7.1.3. CLEANING

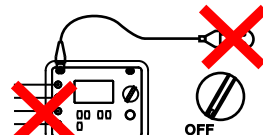
  Use a soft cloth, dampened with soapy water. Rinse with a damp cloth and dry rapidly with a dry cloth or forced air. Do not use alcohol, solvents, or hydrocarbons.

7.1.4. METROLOGICAL CHECK

As with all measuring and testing instruments, a periodic check is necessary. We recommend having this instrument checked at least once a year. For checks and calibrations, get in touch with our accredited metrology laboratories (information and coordinates on request), with the Chauvin Arnoux subsidiary, or with the agent for your country.

7.1.5. UPGRADING THE SOFTWARE OF THE INSTRUMENT

To provide the best possible service at all times - in terms of performance and technical progress -, Chauvin Arnoux makes it possible for you to update the instrument's firmware by downloading the new version, available free of charge on our Web site.

For more information, go to our site <http://www.chauvin-arnoux.com>, under the heading "Software Support Space".

7.2. REPAIR

For all repairs, whether or not under the warranty, send the instrument back to your dealer.

8. WARRANTY

Except as otherwise stated, our warranty is valid for **twelve months** counting from the date on which the equipment is made available. Extract from our General Conditions of Sale, communicated on request.

9. TO ORDER

C.A 6240 P01.1432.00

The C.A 6240 is delivered in a cardboard box with a carrying bag of accessories containing:
one set of two 10 A Kelvin clips with a 3 m cable,
one 2 m power cord,
one optical / USB communication cable,
"Microhmview" software,
5 simplified operating manuals,
and this user manual in 5 languages.





9.1. ACCESSORIES

GB power cord 2 m long P01.2952.53
set of 2 double probe tips P01.1017.82
set of 2 miniature Kelvin clips..... P01.1017.83
C.A 846 thermo-hygrometer P01.1563.01Z
optical / RS communication cable P01.2952.52

9.2. SPARES

set of 10 FF 12 fuses, 5 A – 500 V - 6.3 x 32 mm P01.2970.91
set of two 10 A Kelvin clips with 3 m cable P01.1017.94
2P EURO power cord 2 m long P01.2951.74
standard carrying bag P01.2980.66
optical / USB communication cable HX0056-Z

DEUTSCH

	ACHTUNG, GEFAHRENRISIKO! Bitte lesen Sie die gesamte Betriebsanleitung vor der ersten Verwendung des Geräts sorgfältig durch. Alle mit diesem Symbol versehenen Anweisungen in dieser Betriebsanleitung müssen besonders sorgfältig eingehalten werden, weil sonst Körperverletzungen oder Schäden am Gerät und den Anlagen auftreten könnten.
	Gerät vollständig doppelt- bzw. schutzisoliert.
	Das Symbol „durchgestrichener Mülleimer“ weist darauf hin, dass dieses Gerät in der EU gemäß der EC-Richtlinie für Elektro- und Elektronikschrott WEEE 2002/96/EC entsorgt und recycelt werden muss.
	Erdungsbuchse.

Definition der Messkategorien:

- Die Messkategorie III bezieht sich auf Messungen, die an Gebäudeinstallationen durchgeführt werden.
- Die Messkategorie II bezieht sich auf Messungen, die an Kreisen durchgeführt werden, die direkt an Niederspannungsinstallationen angeschlossen sind.
- Die Messkategorie I bezieht sich auf Messungen an Kreisen, die nicht direkt mit dem Stromnetz verbunden sind.

Sie haben ein **C.A 6240 Micro-Ohmmeter** erworben, und wir danken Ihnen für Ihr Vertrauen. Für die Erlangung eines optimalen Betriebsverhaltens Ihres Gerätes:

- Lesen Sie bitte diese Betriebsanleitung aufmerksam durch.
- Beachten Sie bitte die Bedienungshinweise.

Eines der 5 gelieferten Etiketten mit den technischen Daten in der gewünschten Sprache in den Gehäusedeckel kleben.

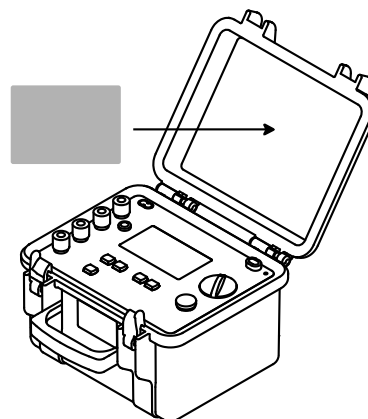

⚠ BEDIENUNGSHINWEISE ⚠

Das Gerät ist gegen Spannungen bis zu 50V gegen Erde bei Messkategorie III geschützt. Die Sicherheit des Gerätes kann bei einer vom Hersteller nicht spezifizierten Anwendung beeinträchtigt werden.

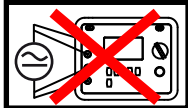

Verwenden Sie dieses Gerät nicht an Leitern mit Netzanschluss oder angeschlossenen Erdleitern.

Stellen Sie sicher, dass der Wahlschalter in Position OFF steht bevor der Netzstecker zur Aufladung des Akkus ans Netz angeschlossen wird.

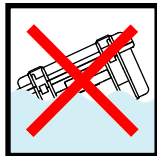
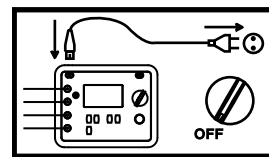

Micro-Ohmmeter C.A 6240 nicht eintauchen.

Verwenden Sie Anschlusszubehör, dessen Überspannungskategorie und Betriebsspannung dem Messgerät entsprechen (50 V Cat III). Verwenden Sie nur Zubehör, das den Sicherheitsauflagen entspricht (IEC 61010-2-031).

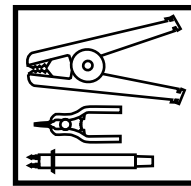

Reparaturen und messtechnische Überprüfungen dürfen nur durch zugelassenes Fachpersonal erfolgen.

INHALTSVERZEICHNIS

1. PRÄSENTATION	46
2. AKKULADUNG	48
3. MESSUNG DES WIDERSTANDES	49
3.1. Messen kleinster Widerstände.....	50
3.2. Mehrfachmessungen.....	51
3.3. Fehlermeldungen.....	51
4. MESSWERTSPEICHER	53
4.1 Speichern.....	53
4.2. Ablesen aus Speicher.....	54
4.3. Löschung eines Speicherwerts.....	54
4.4. Sonstige Informationen	54
4.5. Automatisches Speichern	54
4.6. Datenübertragung auf PC	55
ANDERE FUNKTIONEN (SET-UP)	56
5.1. Löschen des gesamten Speichers	56
5.2. Uhrzeiteinstellung.....	56
5.3. Datumseinstellung.....	56
5.4. Programmieren der automatischen Abschaltfunktion	57
5.5. Anzeige der Geräteparameter.....	57
6. ALLGEMEINE TECHNISCHE DATEN	58
6.1. Referenz Bedingungen.....	58
6.2. Technische Daten der Widerstandsmessung.....	58
6.3. Technische Daten der Spannungsmessung an den Buchsen des Messwiderstands ..	58
6.4. Technische Daten der strommessung im Messwiderstand.....	59
6.5. Einfluß auf Widerstandsmessung	59
6.6. Stromversorgung	59
6.7. Umweltbedingungen	60
6.8. Allgemeine Baudaten	60
6.9. Konformität mit internationalen Normen	60
6.10. Elektromagnetische Verträglichkeit	60
7. WARTUNG	61
7.1. Instandhaltung.....	61
7.2. Reparatur	61
8. GARANTIE	62
9. BESTELLANGABEN	62
9.1. Zubehör.....	62
9.2. Ersatzteile	62

1. PRÄSENTATION

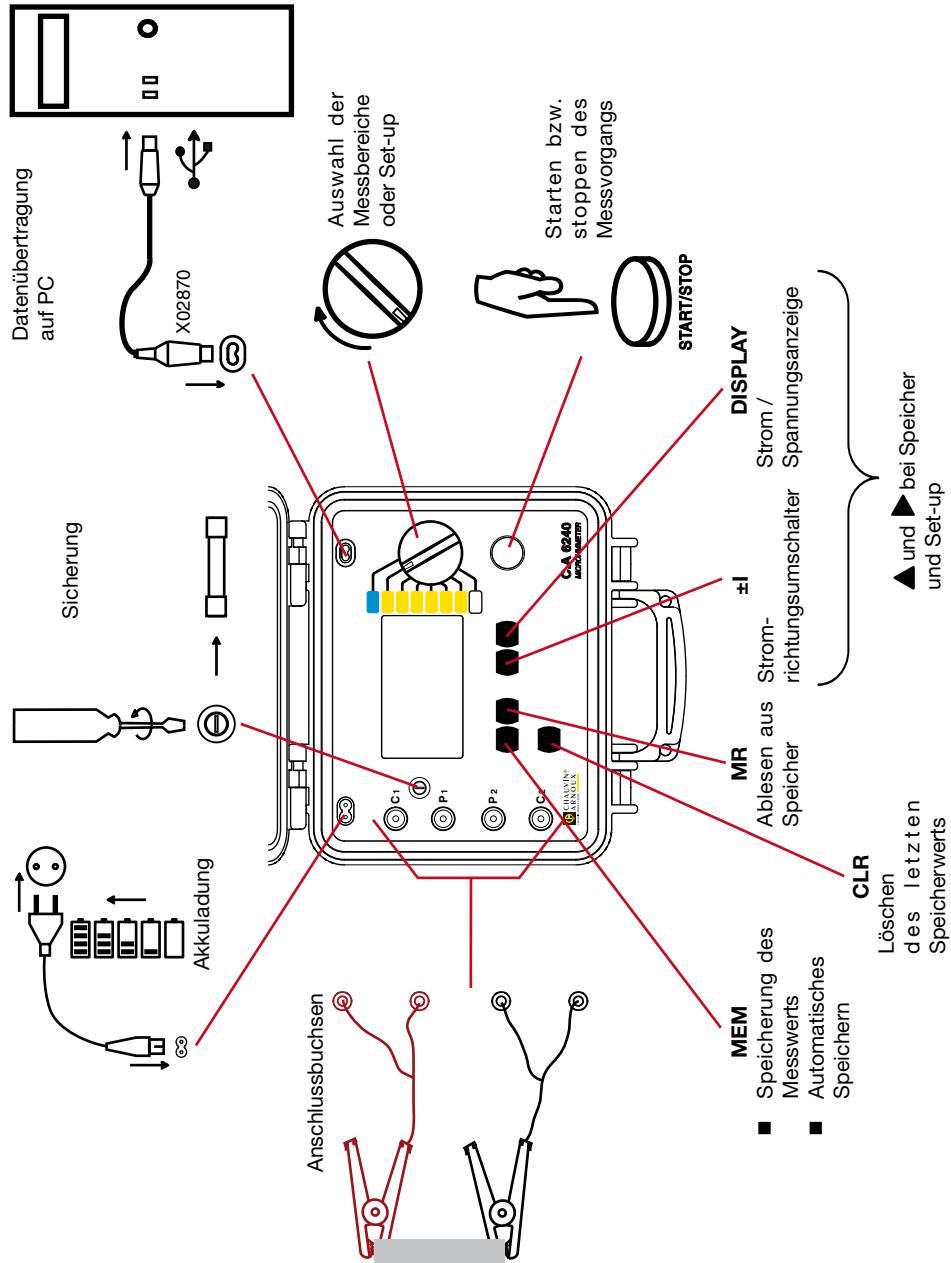

C.A 6240 ist ein tragbares Micro-Ohmmeter zum Messen kleinster Widerstände. Es verfügt über ein baustellentaugliches Gehäuse und wird mit einem wiederaufladbaren Akku versorgt (eingebautes Ladegerät).

Messfunktionen : Widerstand
 Vorgangsweise : 8-Stellungsschalter, 5 Tasten, 1 Ein-Aus-Knopf
 Anzeige : beleuchtete LCD-Anzeige 100 x 57 mm, 2 Zeilen Simultan-Digitalanzeige

Abbildung der Anzeige

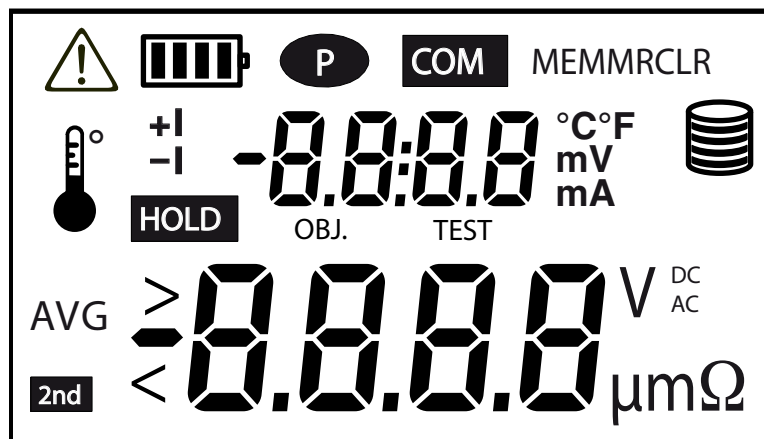

Anzeige blinkt

2. AKKULADUNG

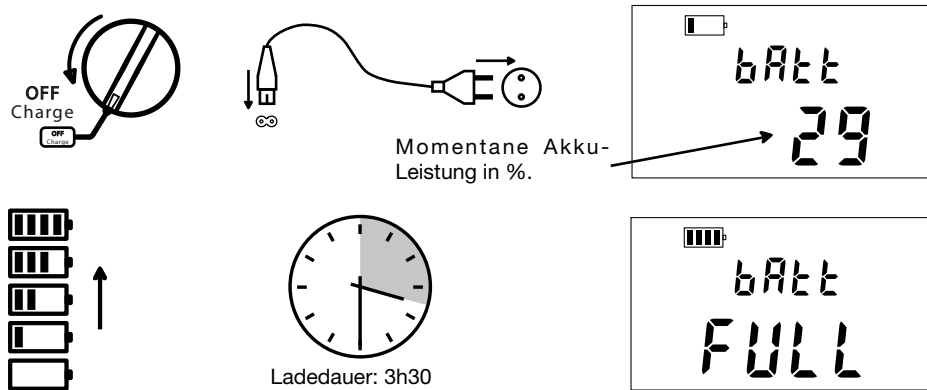

Vor der ersten Verwendung muss der Akku vollständig aufgeladen werden.

Im Messbereich 10A bietet der Akku ca. 1h20 Betriebsdauer. Bevor Sie längere Messungen vornehmen, sollte daher der Akku aufgeladen werden. Ladevorgang bei 0 bis 40°.

Die Betriebsdauer hängt vom Messbereich ab. Anzeigen der Betriebsdauer (bevor eine Messung durchgeführt wird):

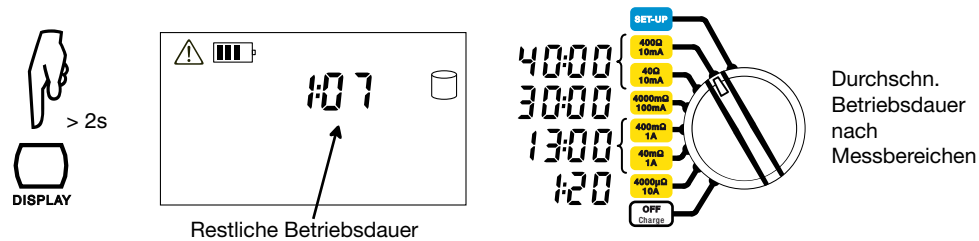

Nach längerer Lagerung ist der Akku eventuell entladen, in diesem Fall dauert das Aufladen mehrere Stunden. Die Akkukapazität und daher die Gerätebetriebsdauer werden dadurch vorübergehend verringert. Nach 5 Ladezyklen erreicht der Akku wieder seine ursprüngliche Kapazität.

3. MESSUNG DES WIDERSTANDES

1) Die 2 Kabel an die 4 Messbuchsen anschließen, dann die 2 Kelvin-Klemmen an das Testobjekt anschließen. Das Testobjekt darf nicht unter Spannung stehen.

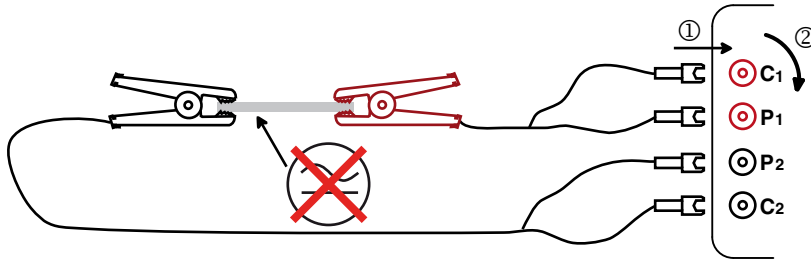

2) Schalter auf $400\Omega - 10\text{ mA}$ stellen.

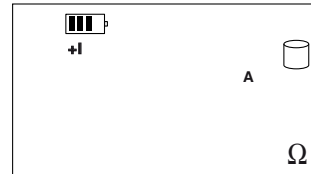
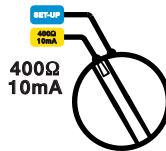

3) Mit START/STOP den Messvorgang starten.

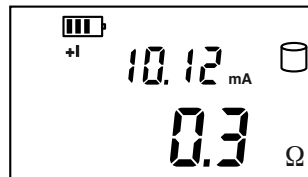

Wenn die Messung zu schwach ist, drehen Sie den Schalter auf den darunterliegenden Messbereich und wiederholen Sie den Messvorgang, bis die Anzeige mindestens dreistellig ist,

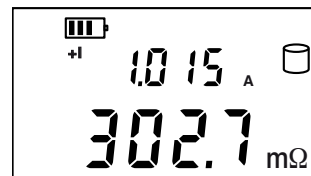
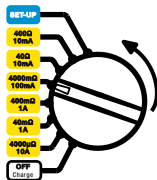

4) Mit START/STOP den Messvorgang beenden...

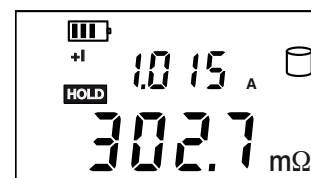

... oder nehmen Sie eine der Klemmen ab.

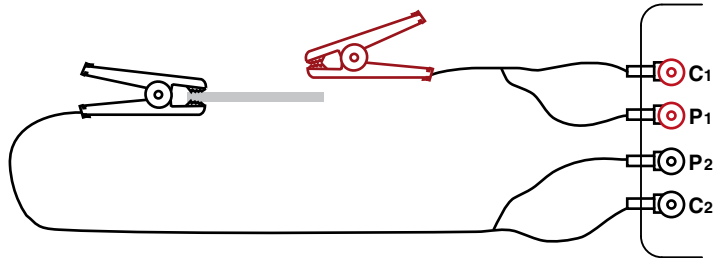

In beiden Fällen werden der letzte Messwert und das **HOLD** Symbol angezeigt.

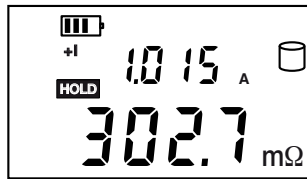

Wenn der Messvorgang durch das Abnehmen einer Klemme unterbrochen wird, startet er wieder, sobald die Klemme an ein neues Testobjekt angeschlossen wird. Die START/STOP Taste muss nicht betätigt werden.

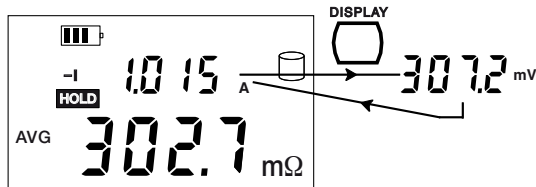

Wenn anstelle des Messstroms die Spannung an den Buchsen des Widerstands angezeigt werden soll, betätigen Sie die Taste DISPLAY.

3.1. MESSEN KLEINSTER WIDERSTÄNDE

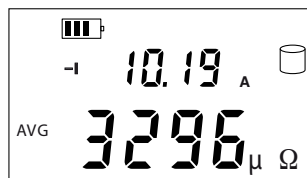
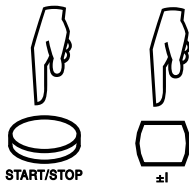

Mit der Taste $\pm I$ die Stromrichtung umschalten. Das Gerät zeigt den Mittelwert an:

$$R_{AVG} = \frac{R(+I) + R(-I)}{2}$$

Dadurch wird die Thermospannung annulliert.

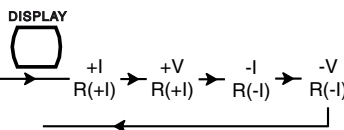
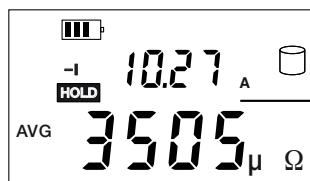

Anzeigen der Werte R(+I) und R(-I): DISPLAY-Taste drücken.

3.2. MEHRFACHMESSUNGEN

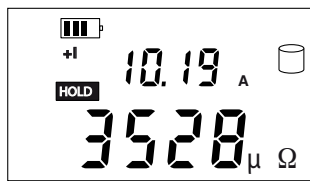
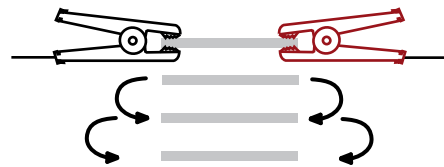
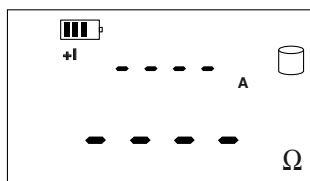
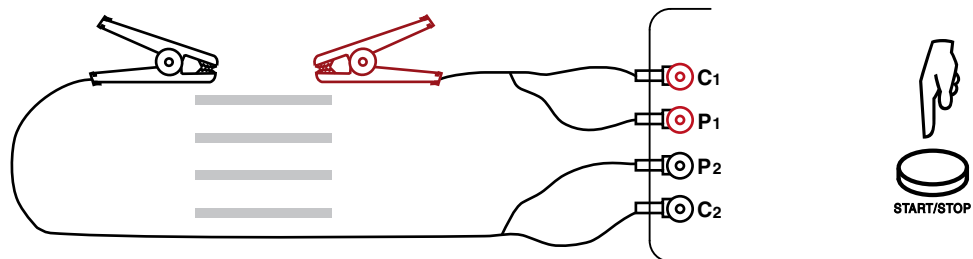

Die Klemmen werden an das erste Testobjekt angeschlossen, der Messvorgang startet automatisch. Nun die Klemmen abnehmen; der Messvorgang wird unterbrochen und der Wert angezeigt. Die Klemmen werden an das nächste Testobjekt angeschlossen, und der Messvorgang startet wieder automatisch. usw. Nach dem letzten Messvorgang erneut die START/STOP Taste betätigen.

3.3. FEHLERMELDUNGEN

3.3.1. SPANNUNG VORHANDEN ⚠

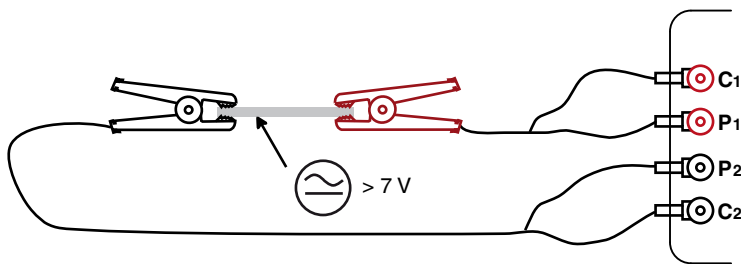

Wenn am Testobjekt eine externe Spannung vorhanden ist,...

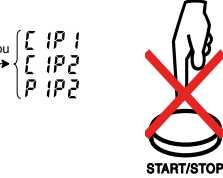
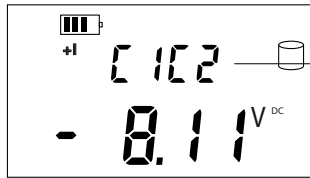

... ist die START/STOP-Taste wirkungslos und ein Messen nicht möglich. Vor dem Messen muss die Spannung entfernt werden.

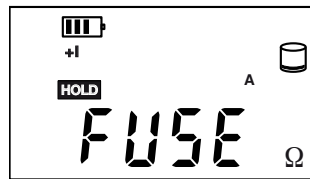
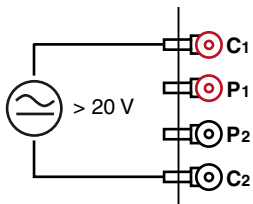

Die Sicherung an der Gerätevorderseite „brennt durch“ und muss ausgetauscht werden, wenn zwischen den Buchsen C1 und C2 eine Spannung über 20 V gelegt wird.

3.3.2. MESSBEREICHSÜBERSCHREITUNG



Zeigt das Gerät eine Messbereichsüberschreitung an (Symbol >) drehen Sie den Schalter auf den nächsten Messbereich und starten Sie den Messvorgang neu. Wiederholen bis das Symbol > Messbereichsüberschreitung nicht mehr angezeigt wird.

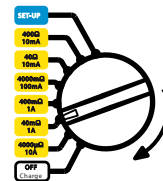

3.3.3. MESSRAUSCHEN

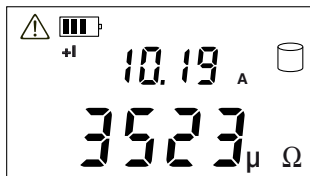

⚠ zeigt an, dass ein Messrauschen vorliegt und keine Messgenauigkeit garantiert werden kann.

3.3.4 ÜBERHITZUNG

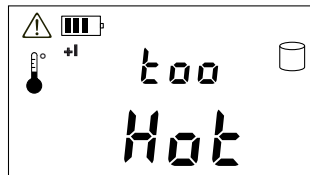

Wird im Messbereich 10 A mehrere Minuten lang gemessen, kann eine interne Überhitzung auftreten, die weitere Messvorgänge unmöglich macht. Mit weiteren Messungen muss gewartet werden, bis das Gerät ausgekühlt ist.

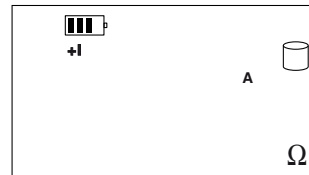

4. MESSWERTSPEICHER

Die Datenspeicherung ist nach Gegenständen (OBJ) sortiert, denen mehrere Tests (TEST) zugeordnet werden können. OBJ steht für das Testobjekt, jeder Test entspricht einem Messwert für diesen Gegenstand. Das Gerät kann bis zu 100 Messwerte speichern.

4.1 SPEICHERN

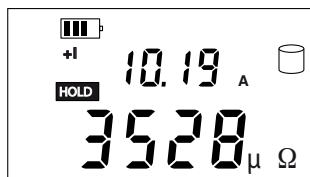

Der gemessene Wert kann gespeichert werden. Betätigen Sie die MEM Taste.



Das Gerät bietet den ersten freien Speicherplatz an. Wenn Sie diesen Speicherplatz verwenden möchten, bestätigen Sie durch langes Drücken der MEM-Taste.

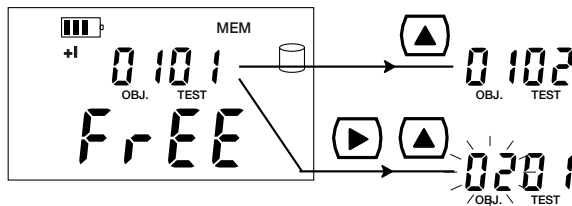
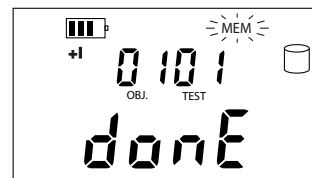
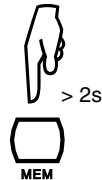

Zum Ändern der Test- oder Gegenstandnummer verwenden Sie die Pfeile.

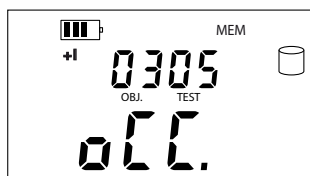

Ist der gewählte Speicherplatz nicht frei, informiert Sie das Gerät. Sie haben aber die Möglichkeit, den vorhandenen Wert durch den neuen Messwert zu ersetzen.

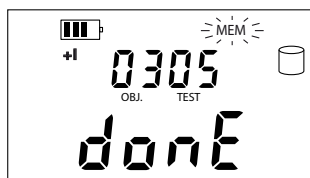
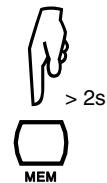

oder

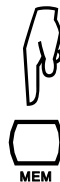

Verlassen der Funktion ohne zu speichern; die MEM-Taste drücken.

4.2. ABLESEN AUS SPEICHER

Zuerst muss mit START/STOP der Messvorgang unterbrochen werden.

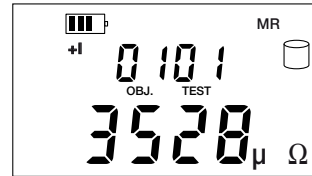
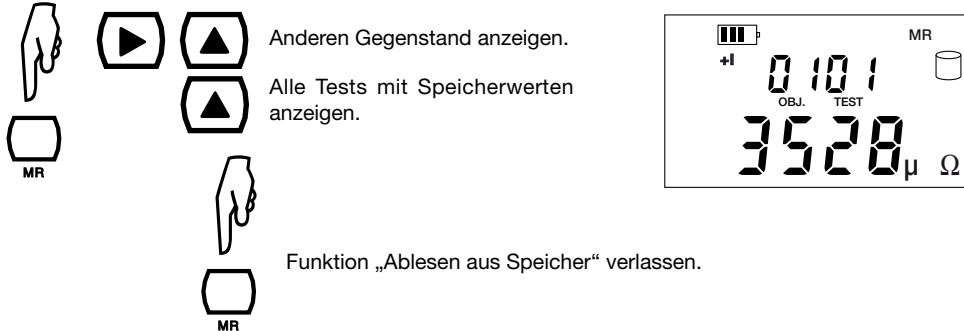

4.3. LÖSCHUNG EINES SPEICHERWERTS

Löschen eines Speicherwerts (AbleSEN aus Speicher oder nicht):

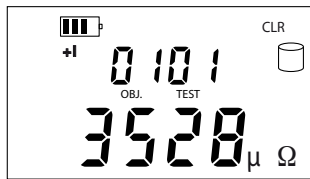
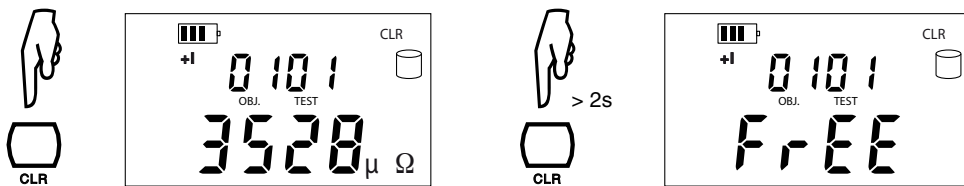

4.4. SONSTIGE INFORMATIONEN

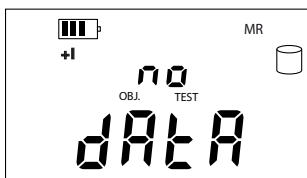

Speicher leer

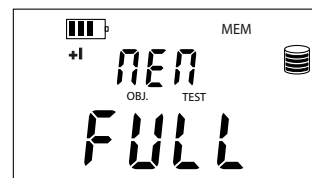

Speicher voll

4.5. AUTOMATISCHES SPEICHERN

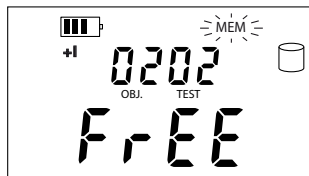
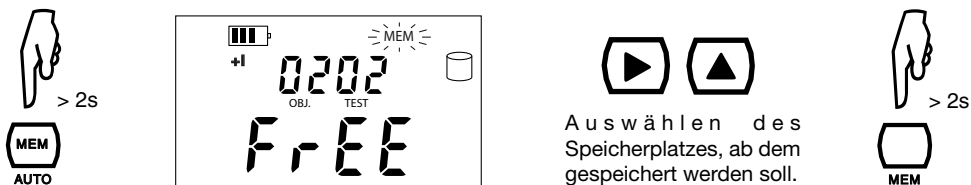

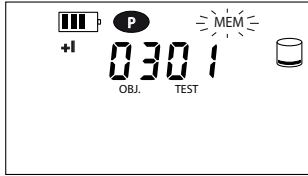

Automatische Speicherfunktion ist aktiviert.

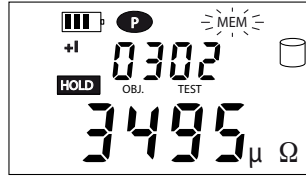

Mit jedem neuen Messwert wird die Testnummer erhöht und der Wert gespeichert.

Beenden der automatischen Speicherfunktion: START/STOP Taste drücken.

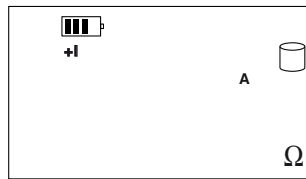

4.6. DATENÜBERTRAGUNG AUF PC

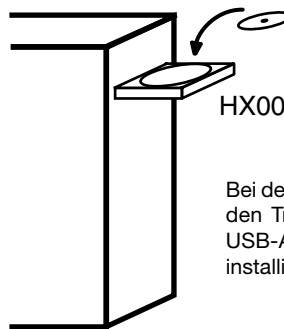
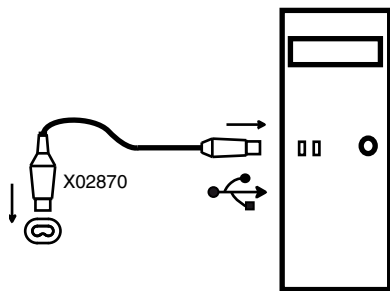

HX0056-Z

Bei der ersten Übertragung, den Treiber des optischen USB-Adapters (HX0056-Z) installieren

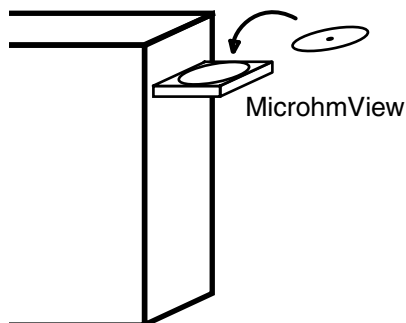

MicrohmView

Anschließend das Programm MicrohmView mit der Datei readme.txt installieren.

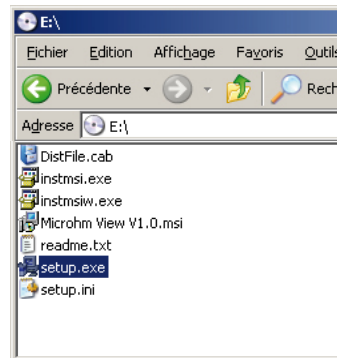

Für die Anwendung von Microhmview lesen Sie bitte in der Hilfe nach.

ANDERE FUNKTIONEN (SET-UP)

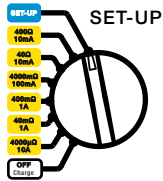

5.1. LÖSCHEN DES GESAMTEN SPEICHERS

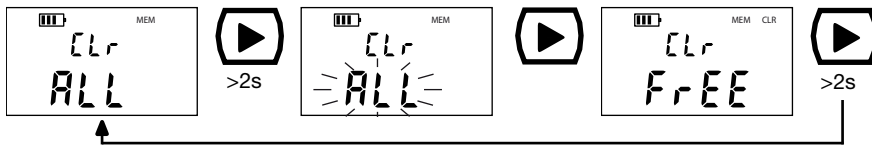

5.2. UHRZEITEINSTELLUNG



5.3. DATUMSEINSTELLUNG

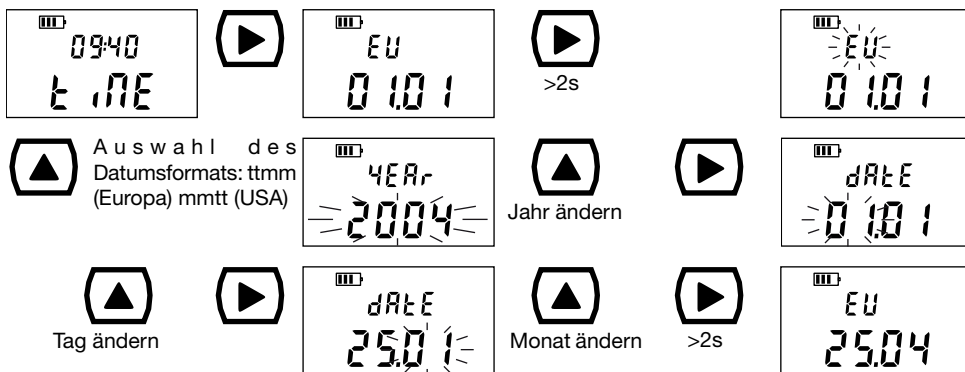

5.4. PROGRAMMIEREN DER AUTOMATISCHEN ABSCHALTFUNKTION

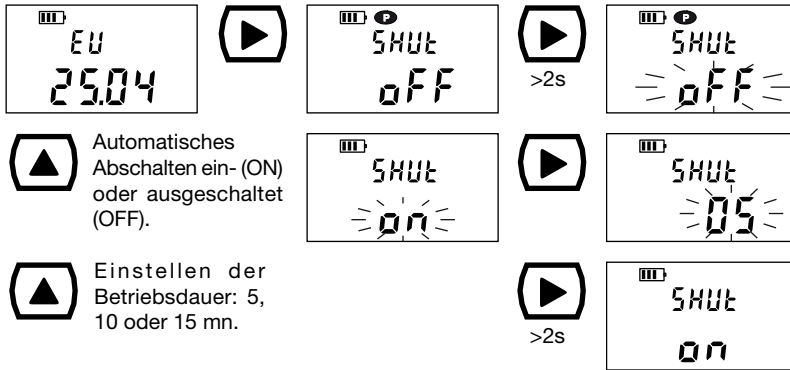

5.5. ANZEIGE DER GERÄTEPARAMETER

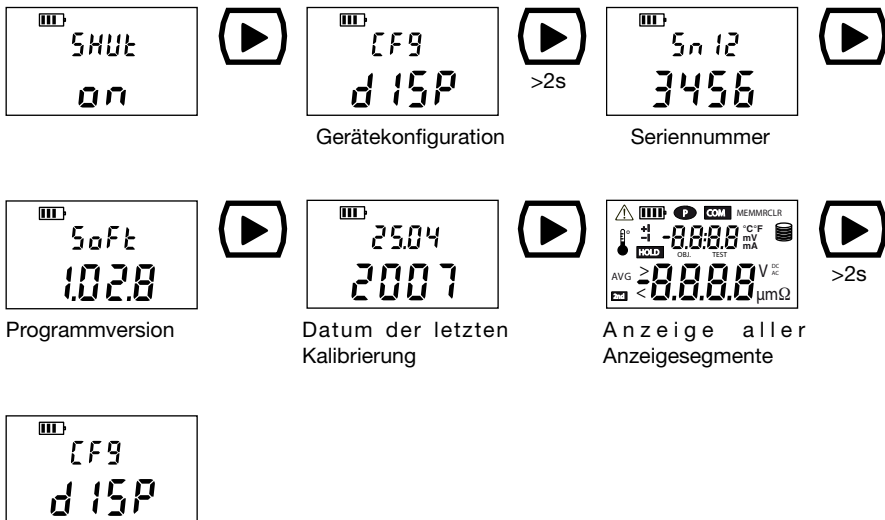

6. ALLGEMEINE TECHNISCHE DATEN

6.1. REFERENZ BEDINGUNGEN

Einflussgröße	Referenzwerte
Temperatur	23 ± 3 °C
Relative Feuchte	45 bis 55 % r.F.
Spannungsversorgung	6 V ± 0,2 V
Externe Spannung an den Buchsen des Testwiderstands	keine
Induktivität des Testwiderstands	keine
Elektrische Feldstärke	keine
Magnetische Feldstärke	< 40 A/m

6.2. TECHNISCHE DATEN DER WIDERSTANDSMESSUNG

Das Testobjekt muss spannungsfrei sein.

Messbereich	5 - 3999 $\mu\Omega$	4,00 - 39,99 m Ω	40,0 - 399,9 m Ω	400 - 3999 m Ω	4,00 - 39,99 Ω	40,0 - 399,9 Ω
Auflösung	1 $\mu\Omega$	10 $\mu\Omega$	100 $\mu\Omega$	1 m Ω	10 m Ω	100 m Ω
Genauigkeit	± 0,25% ± 2 D					
Messstrom	10,2 A ± 2% (1)	1,02 A ± 2%		102 mA ± 2%	10,2 mA ± 2% (2)	
Leerlaufspannung	4 bis 6 V					

(1) Bei Nennwert 10,2 A beträgt der Mindest-Messstrom ungeachtet des Akku-Ladezustands immer 10 A.

(2) Der Strom entspricht nur bis 300 Ω 10 mA. Bei schwachem Akku kann er auf bis zu 8 mA sinken.

6.3. TECHNISCHE DATEN DER SPANNUNGSMESSUNG AN DEN BUCHSEN DES MESSWIDERSTANDS

Messbereich	0,010 - 3,999 mV	4,00 - 39,99 mV	40,0 - 399,9 mV	0,400 - 3,999 V	4,00 - 4,70 V
Auflösung	1 μ V	10 μ V	100 μ V	1 mV	10 mV
Genauigkeit	± 0,5% ± 10 D		± 0,5% ± 1 D		

6.4. TECHNISCHE DATEN DER STROMMESSUNG IM MESSWIDERSTAND

Messbereich	5,00 – 39,99 mA	40,0 – 399,9 mA	0,400 – 3,999 A	4,00 – 11,00 A
Auflösung	10 µA	100 µA	1 mA	10 mA
Genauigkeit	± 0,5% ± 2 D		± 0,5% ± 1 D	

6.5. EINFLUß AUF WIDERSTANDSMESSUNG

Einflussgröße	Grenzwerte bei Betrieb	Messabweichung	
		Typisch	Maximal
Temperatur	-10 bis + 55 °C	0,1 %/10 °C	0,5 %/10 °C + 2 D
Relative Feuchtigkeit	10 bis 85 % r.F. @ 45°C	0,1 %	0,5 % + 2 D
Spannungsversorgung	5 bis 7 V	2 D	0,2%/ V + 2 D
Serientaktunterdrückung 50/60 Hz (1)	$U (AC) = (R \text{ Messwert} \times I \text{ Messwert})$	< 0,2%	2% + 1 D
Gleichtaktunterdrückung AC 50/60 Hz	0 bis 50 V AC	> 80 dB	> 60 dB

(1) Beispiel: Wenn der gemessene Widerstand 1 mΩ beträgt und der Messstrom 10 A, kann eine Wechselspannung von 1 mV eff in Serientakt mit dem gemessenen Widerstand keinen Fehler von über 2% ergeben.

6.6. STROMVERSORGUNG

Das Gerät wird mit einem wiederaufladbarem NiMH Akku (6V 8,5Ah) versorgt. Dieser bietet zahlreiche Vorteile:

- Hohe Betriebsdauer bei geringer Größe und Gewicht,
- rasches Aufladen des Akkus,
- Geringer Speichereffekt: Selbst ein nicht vollständig entladener Akku wird rasch und ohne Kapazitätsverlust aufgeladen,
- Umweltfreundlich: Keine umweltbelastenden Stoffe wie Blei oder Kadmium.

Die NiMH-Technologie ermöglicht eine begrenzte Anzahl Ladezyklen. Diese Anzahl hängt von den Nutzungs- und Ladebedingungen ab. Unter optimalen Bedingungen sind 200 Zyklen möglich.

Das Gerät besitzt 2 Auflademodi:

- Rasches Aufladen: Der Akku erreicht in 3 Stunden Ladezeit 90% seiner Kapazität;
- Wartungsaufladen: Dieser Modus erscheint, wenn der Akku sehr schwach ist und am Ende des raschen Aufladens.

Die Betriebsdauer hängt von den Messbereichen ab.

	Anzahl Messungen (1)
Messbereich 10 A	850
Messbereich 1 A	3 500
Messbereich 100 mA	4 500
Messbereich 10 mA	5 000
Gerät in Standby oder ausgeschaltet	Betriebsdauer 4 bis 6 Monate

(1) ausgehend von 5 Sek. Messungen alle 25 Sek.

6.7. UMWELTBEDINGUNGEN

Benutzung in Innenräumen und im Freien

Betriebsbereich - 10 bis +55 °C 10 bis 85 % r.F.

Lagerung (ohne Akku) - 40 bis +70 °C 10 bis 90 % r.F.

Höhenlage < 2000 m

Verschmutzungsgrad 2

Bei langer Lagerung mit Akku (2 Jahre) dürfen -20 bis +30°C bzw. 85% r.F. nicht überschritten werden, weil sonst die Akkueigenschaften beeinträchtigt werden. Bei kurzer Lagerung (1 Monat) kann die Temperatur bis 50°C ansteigen.

6.8. ALLGEMEINE BAUDATEN

Gesamtmaße (L x B x H): 273 x 247 x 176 mm

Gewicht: Ca. 4,5 kg

IP 53 gemäß NF EN 60529 (Ausg. 92)

IK 04 gemäß NF EN 50102 (Ausg. 95)

6.9. KONFORMITÄT MIT INTERNATIONALEN NORMEN

Elektrische Sicherheit gem. EN 61010-1 (Ausg. 2 2001).

Messung gemäß EN 61557 (Ed. 2 von 2007) Teil 1 und 4.

Zugewiesene Eigenschaften: Messkategorie III, 50 V gegen Erde, 500 V Differenzspannung zwischen den Buchsen, 300 V Kat II am Eingang zum Ladegerät.

6.10. ELEKTROMAGNETISCHE VERTRÄGLICHKEIT

Das Gerät entspricht den Richtlinien EMV und NSR für die CE-Marke und der Produktnorm EN 61326-1 (Ausg. 97) + A1 (Ausg. 98)

- Emission in Wohngebieten
- Störfestigkeit in industrieller Umgebung

7. WARTUNG

⚠ Bei der Wartung des Gerätes dürfen nur die angegebenen Ersatzteile verwendet werden. Der Hersteller kann nicht für Unfälle oder Schäden haftbar gemacht werden, die auf eine außerhalb des Kundendienstes des Herstellers oder von nicht zugelassenen Reparaturwerkstätten durchgeführte Reparatur des Gerätes zurückzuführen sind.

7.1. INSTANDHALTUNG

7.1.1. AKKU AUFLADEN



⚠ Der Akku muss von Manumasure oder einer zugelassenen Chauvin Arnoux Reparaturwerkstätte ausgetauscht werden. Nur den vom Hersteller spezifizierten Akku montieren. Kein Verlust der Speicherdaten beim Akku-Wechsel. Datum und Uhrzeit (siehe Abs. 5.2 und 5.3) müssen allerdings neu eingestellt werden.

7.1.2. SICHERUNGEN WECHSELN

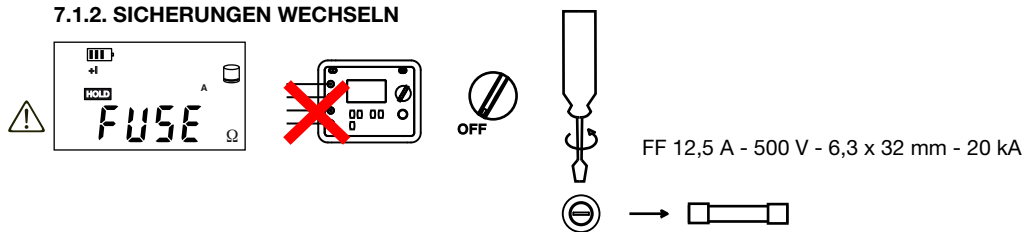

7.1.3. REINIGUNG

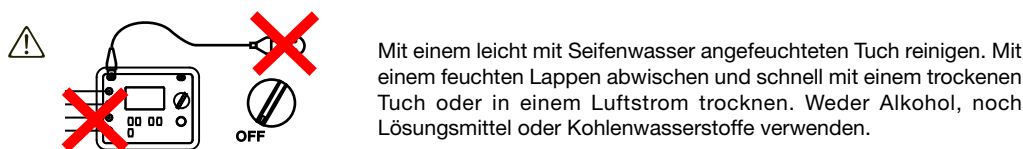

7.1.4. MESSTECHNISCHE ÜBERPRÜFUNG

Wie auch bei anderen Mess- oder Prüfgeräten ist eine regelmäßige Geräteüberprüfung erforderlich. Es wird mindestens eine einmal jährlich durchgeführte Überprüfung dieses Gerätes empfohlen. Für Überprüfung und Kalibrierung wenden Sie sich bitte an unsere zugelassenen Messlabors (Auskunft und Adressen auf Anfrage), bzw. an die Chauvin Arnoux Niederlassung oder den Händler in Ihrem Land.

7.1.5. AKTUALISIERUNG DES GERÄTEPROGRAMMS

Chauvin Arnoux ist ständig darauf bedacht, bestmögliche Leistungen zu erbringen und technische Entwicklungen zu berücksichtigen. Daher haben Sie auf unserer Webseite die Möglichkeit, das Geräteprogramm (Firmware) zu aktualisieren, indem Sie die neue Softwareversion herunterladen. Nähere Informationen finden Sie auf unserer Homepage <http://www.chauvin-arnoux.com>, Rubrik „Bereich Software-Support“.

7.2. REPARATUR

Für alle Reparaturarbeiten (mit oder ohne Garantie) schicken Sie das Gerät Ihrem Händler.

8. GARANTIE

Mit Ausnahme von ausdrücklichen anders lautenden Vereinbarungen ist Garantiezeit **zwölf Monate** ab Bereitstellungsdatum des Geräts. Auszug aus den Allgemeinen Geschäftsbedingungen (Gesamttext auf Anfrage).

9. BESTELLANGABEN

C.A 6240 P01.1432.00

Das C.A 6240 wird in einem Karton mit Zubehörtasche geliefert. Inhalt:
Satz mit 2 Kelvin-Klemmen (10 A, Kabel 3 m),
Netzkabel (2 m),
Optisches USB-Anschlusskabel,
Software „Microhmview“,
5 Kurzanleitungen,
und diese Betriebsanleitung in 5 Sprachen.

9.1. ZUBEHÖR

Netzkabel GB (2 m) P01.2952.53
Satz mit 2 doppelten Prüfspitzen P01.1017.82
Satz mit 2 kleinen Kelvin-Klemmen P01.1017.83
Thermo-Hygrometer C.A 846 P01.1563.01Z
Optisches RS232-Anschlusskabel P01.2952.52

9.2. ERSATZTEILE

10 Sicherungen FF 12,5 A – 500 V - 6,3 x 32 mm P01.2970.91
Satz mit 2 Kelvin-Klemmen (10 A, Kabel 3 m) P01.1017.94
Netzkabel (2 m) 2P EURO P01.2951.74
Standard-Zubehörtasche P01.2980.66
Optisches USB-Anschlusskabel HX0056-Z

ITALIANO

 **ATTENZIONE, PERICOLO!** Consultare il libretto di funzionamento prima di utilizzare l'apparecchio.
Nel presente libretto di funzionamento, le istruzioni precedute da questo simbolo, vanno scrupolosamente assimilate e rispettate: altrimenti possono prodursi incidenti fisici o danni all'apparecchio e agli impianti.

 Apparecchio protetto da isolamento doppio o rinforzato.

 La pattumiera sbarrata significa che nell'Unione Europea, il prodotto costituisce un rifiuto da smistare per l'opportuno riciclo dei materiali elettrici ed elettronici conformemente alla direttiva WEEE 2002/96/CE.

 Terminale di terra.

Definizione delle categorie di misura:

- La categoria di misura III corrisponde alle misurazioni effettuate nell'impianto dell'edificio.
- La categoria di misura II corrisponde alle misurazioni effettuate sui circuiti direttamente collegati all'impianto di bassa tensione.
- La categoria di misura I corrisponde alle misurazioni effettuate su circuiti non collegati direttamente alla rete.

Avete appena acquistato un **microhmetro C.A 6240** e vi ringraziamo della vostra fiducia.

Per ottenere le migliori prestazioni dal vostro apparecchio:

- leggete attentamente il presente libretto di funzionamento
- rispettate le precauzioni d'uso

Attaccare una delle 5 etichette con la lingua appropriate all'interno del coperchio.

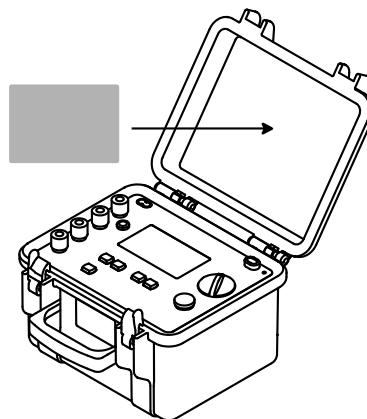

⚠ PRECAUZIONI D'USO ⚠

Il presente apparecchio è protetto contro le tensioni fortuite non superiori a 50V rispetto alla terra in categoria di misura III. Il livello di protezione garantito per questo apparecchio potrebbe essere compromesso se utilizzato in modi non specificati dal produttore.

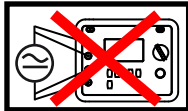

Non utilizzare su conduttori capaci d'essere collegati alla rete o su conduttori di terra non disinseriti.

Verificare che il commutatore sia posizionato su OFF prima di collegare la presa rete per ricaricare la batteria dell'apparecchio.

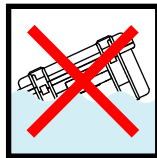
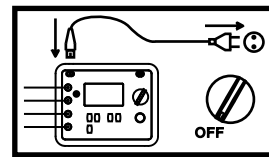

Non immergere il microhmmetro C.A 6240.

Utilizzare accessori d'allacciamento la cui categoria di sovratensione e la tensione di servizio sono superiori o uguali a quelle dell'apparecchio di misura (50 V Cat. III). Utilizzare solo accessori conformi alle norme di sicurezza (IEC 61010-2-031).

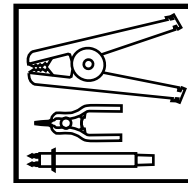

Qualsiasi procedura di riparazione o di verifica metrologica va effettuata da personale competente e abilitato.

INDICE

1. PRESENTAZIONE	66
2. CARICA BATTERIA	68
3. MISURA DI RESISTENZA	69
3.1. Misura di debolissimo valore	70
3.2. Misure ripetitive	71
3.3. Messaggi d'errore.....	71
4. MEMORIZZAZIONE DEI RISULTATI	73
4.1 Memorizzazione.....	73
4.2. Rilettura memoria	74
4.3. Soppressione memoria	74
4.4. Informazioni complementari	74
4.5. Registrazione automatica	74
4.6. Trasferimento dei dati su PC.....	75
5. ALTRE FUNZIONI (SET-UP)	76
5.1. Soppressione completa della memoria.....	76
5.2. Programmazione dell'ora	76
5.3. Programmazione della data	76
5.4. Programmazione del tempo di bloccaggio automatico	77
5.5. Visualizzazione dei parametri interni dell'apparecchio	77
6. CARATTERISTICHE	78
6.1. Condizioni di riferimento	78
6.2. Caratteristiche delle misure di resistenza	78
6.3. Caratteristiche delle misure di tensione ai morsetti della resistenza misurata	78
6.4. Caratteristiche delle misure di tensione ai morsetti della resistenza misurata	79
6.5. Influenze sulla misura di resistenza.....	79
6.6. Alimentazione	79
6.7. Condizioni ambientali.....	80
6.8. Caratteristiche costruttive.....	80
6.9. Conformità alle norme internazionali.....	80
6.10. Compatibilità elettromagnetica.....	80
7. MANUTENZIONE	81
7.1. Verifiche correnti	81
7.2. Riparazione	81
8. GARANZIA	82
9. PER ORDINARE	82
9.1. Accessori	82
9.2. Pezzi di ricambio	82

1. PRESENTAZIONE

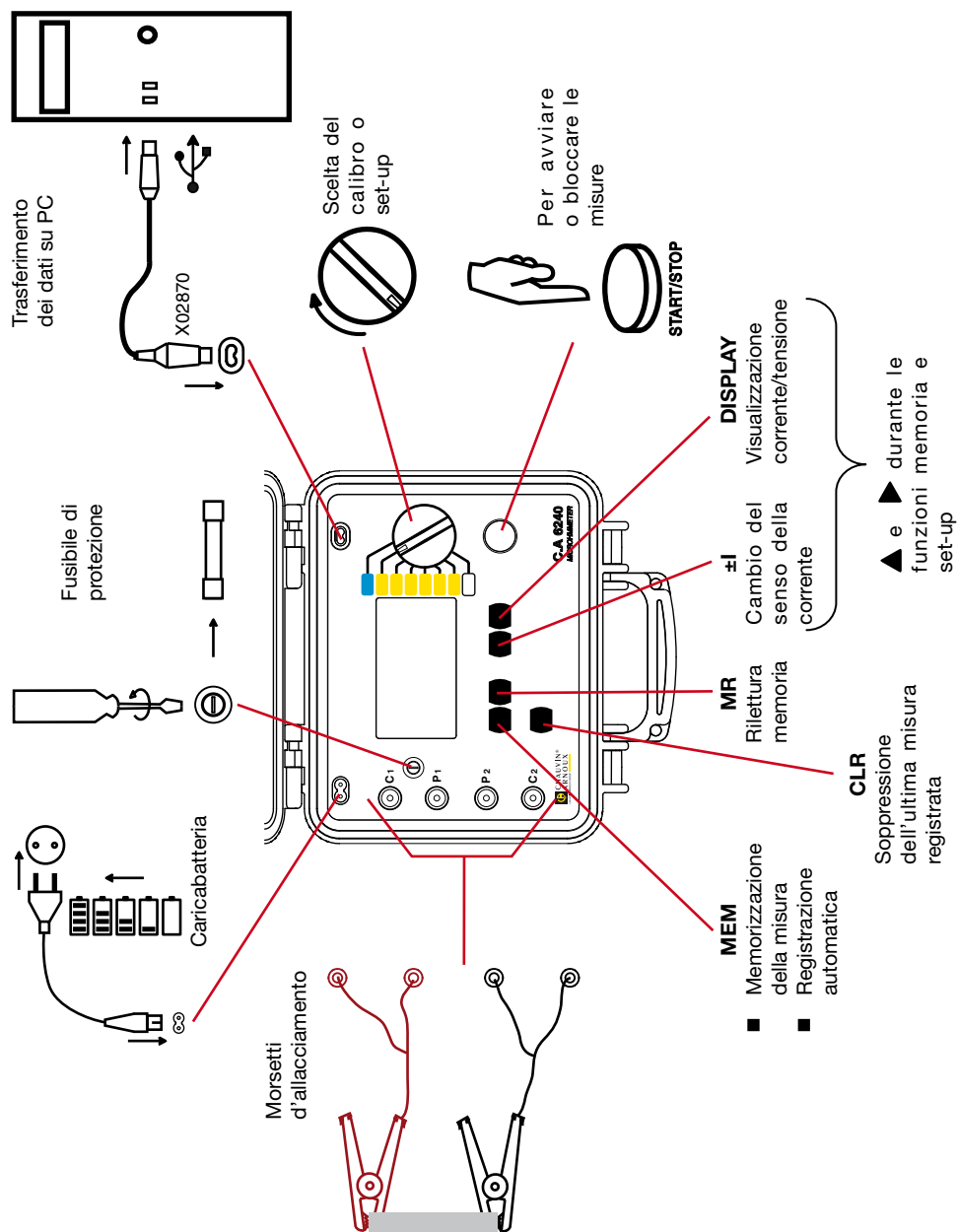

Il Microhmetro C.A 6240 è un apparecchio di misura portatile destinato alla misura di debolissimi valori di resistenze. Viene presentato in un contenitore per cantiere. Viene alimentato da una batteria ricaricabile con caricatore integrato.

- Funzioni di misura : resistenza
- Messa in opera : commutatore otto posizioni, tastiera cinque tasti e un bottone START/STOP
- Visualizzazione : display LCD 100 x 57 mm, retroilluminato, costituito da 2 livelli di visualizzazione digitale simultanea

Rappresentazione del display

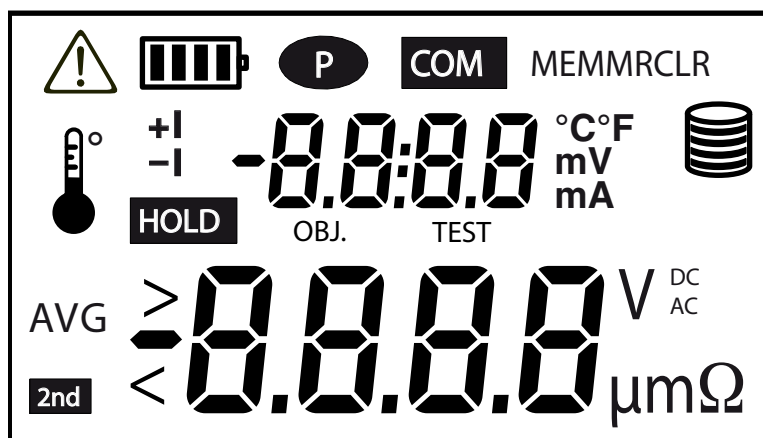

Indica un lampeggiamento

2. CARICA BATTERIA

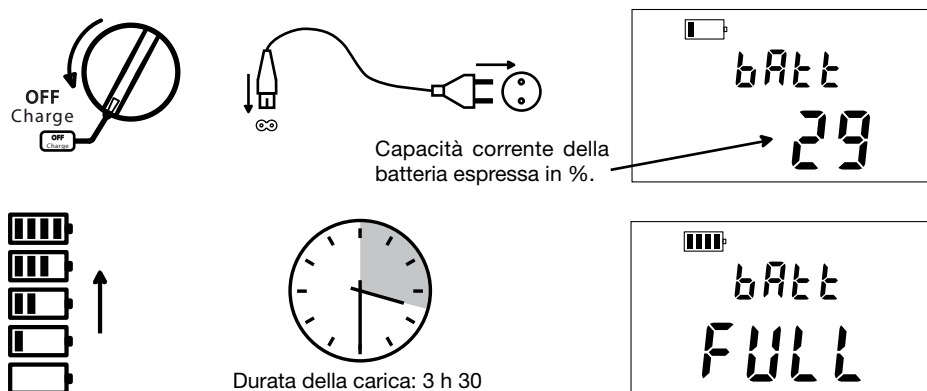

Iniziare caricando completamente la batteria al primo utilizzo.

Sul calibro 10 A, l'autonomia è di 1 h 20 circa. Quindi è preferibile caricare la batteria prima d'avviare una campagna di misura. La carica va effettuata fra 0 e 40°C.

L'autonomia dell'apparecchio dipende dal calibro. Per visualizzarla (primo di effettuare la misura):

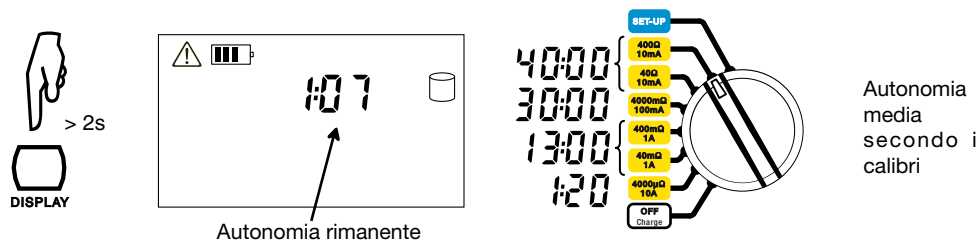

In seguito ad uno stoccaggio di lunga durata, è possibile che la batteria sia completamente scarica. In questo caso, la prima carica può durare varie ore. La capacità della batteria e quindi l'autonomia dell'apparecchio saranno temporaneamente ridotte. La batteria ritroverà la sua capacità iniziale dopo 5 cicli di ricarica.

3. MISURA DI RESISTENZA

1) Allacciare i 2 cavi sui 4 morsetti di misura, poi le 2 pinze Kelvin sull'oggetto da testare. Quest'ultimo dovrà essere fuori tensione.

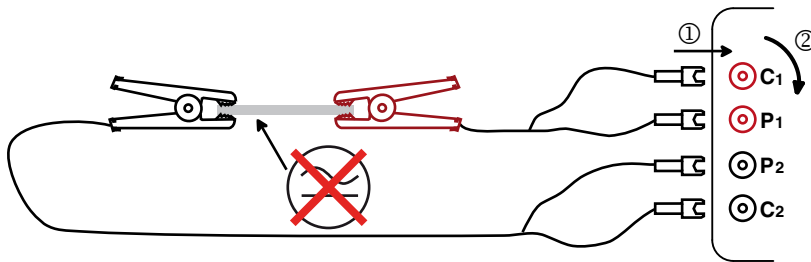

2) Posizionare il commutatore su $400\Omega - 10\text{ mA}$.

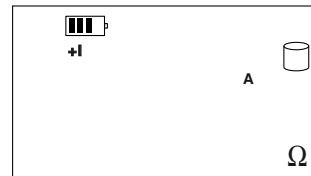
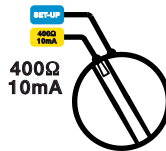

3) Avviare la misura premendo il bottone START/STOP.

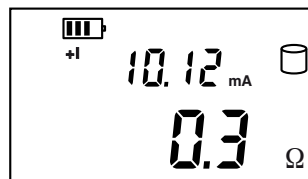

Se la misura è troppo debole, ruotare allora il commutatore sul calibro precedente, e riavviare la misura. Continuare finché la visualizzazione avverrà su almeno 3 cifre.

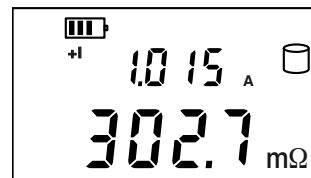
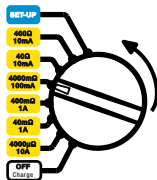

4) Premere di nuovo il bottone START/STOP per bloccare la misura...

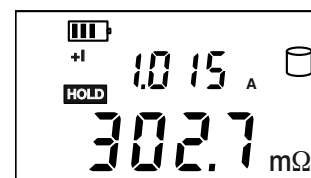

...oppure disinserire una delle 2 pinze.

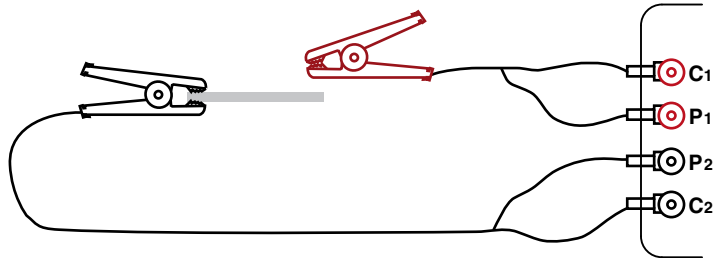

Nei due casi, l'ultima misura effettuata viene visualizzata come pure il simbolo **HOLD**

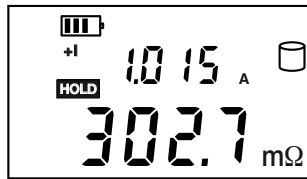

Se la misura è bloccata dal disinserimento di una pinza, basta inserirle nuovamente su un nuovo oggetto per avviare una nuova misura, senza premere il tasto START/STOP.

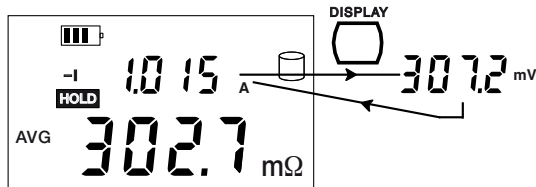

Per visualizzare la tensione ai morsetti della resistenza anziché la corrente di misura, premere il tasto DISPLAY.

3.1. MISURA DI DEBOLISSIMO VALORE

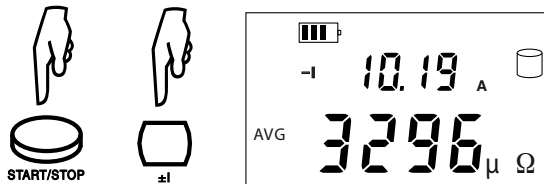

Invertire il senso della corrente premendo il tasto ±I, e l'apparecchio visualizza la media:

$$R_{AVG} = \frac{R(+I) + R(-I)}{2}$$

Ciò permette di liberarsi dagli effetti delle termocoppie.

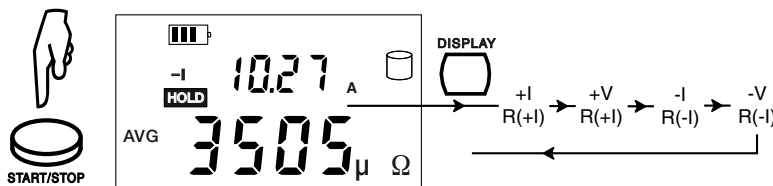

Per visualizzare i valori R(+I) e R(-I), premere il tasto DISPLAY.

3.2. MISURE RIPETITIVE

Allacciare le pinze sul primo oggetto da misurare. La misura si avvia automaticamente. Rimuovere le pinze, la misura si blocca e il risultato si visualizza. Allacciare le pinze sul secondo oggetto da misurare. La misura si riavvia automaticamente. E così via. Alla fine dell'ultima misura, premere di nuovo il bottone START/STOP.

3.3. MESSAGGI D'ERRORE

3.3.1. PRESENZA DI UNA TENSIONE ⚠

In caso di presenza di una tensione esterna sul dispositivo da misurare...

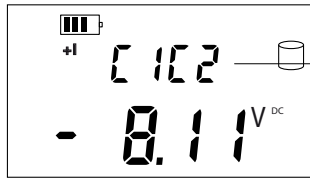

...premere il bottone START/STOP è senza effetto, la misura è impossibile. Sopprimere la tensione per effettuare la misura.

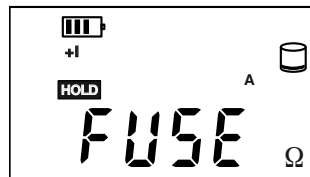
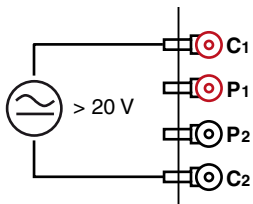

Se si applica una tensione superiore a 20 V fra i morsetti C1 e C2, il fusibile posto sulla faccia anteriore dell'apparecchio è distrutto e occorre sostituirlo (vedasi § 7.1.2)

3.3.2. SUPERAMENTO DEL CALIBRO

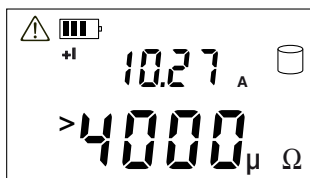

Se l'apparecchio indica un superamento di calibro (simbolo >), ruotare allora il commutatore sul calibro seguente, e riavviare la misura. Continuare fino alla visualizzazione del messaggio di superamento del calibro.

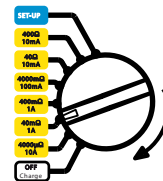

3.3.3. MISURA PERTURBATA

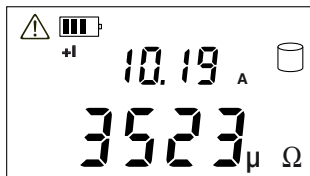

Il simbolo ⚠ segnala che la misura è perturbata e che la sua precisione non è garantita.

3.3.4. SURRISCALDAMENTO

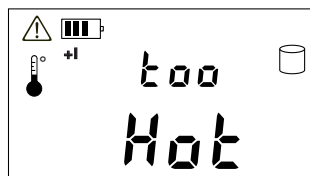

Se una misura sul calibro 10 A dura vari minuti, si produce un surriscaldamento interno che impedisce qualsiasi misura. Occorre lasciare raffreddare l'apparecchio per procedere alle misure.

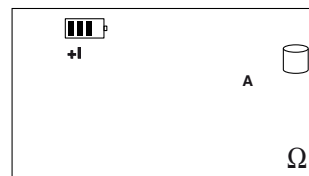

4. MEMORIZZAZIONE DEI RISULTATI

Lo stoccaggio dei dati viene organizzato in oggetti (OBJ.): ciascuno può contenere vari test (TEST). OBJ. corrisponde all'oggetto testato ed ogni test corrisponde ad una misura effettuata su quest'oggetto. L'apparecchio può stoccare 100 misure.

4.1 MEMORIZZAZIONE

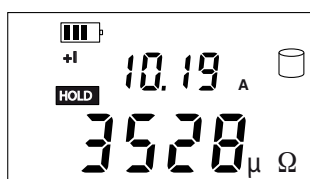

Una volta terminata, la misura può venire registrata. Premere il tasto MEM.

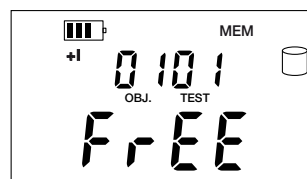

L'apparecchio propone la prima casella memoria libera. Se la casella è appropriata, effettuate una pressione lunga sul tasto MEM.

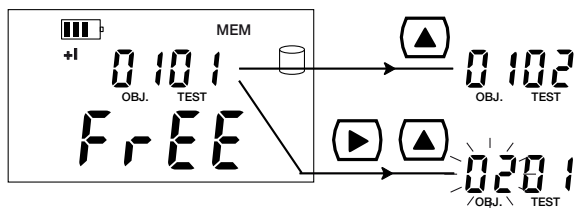
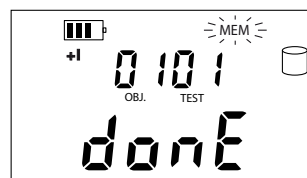
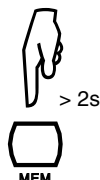

Per modificare il numero del test o dell'oggetto, utilizzare i tasti.

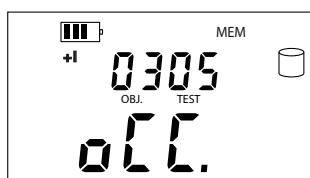

Se l'ubicazione scelta è già occupata, l'apparecchio lo segnala. Ma è possibile sostituirla con la nuova misura.

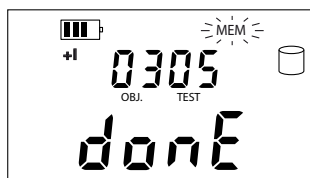
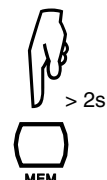

oppure

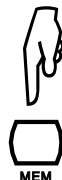

Per uscire della funzione senza registrare nulla, premere il tasto MEM.

4.2. RILETTURA MEMORIA

Occorre innanzitutto bloccare la misura premendo il bottone START/STOP.

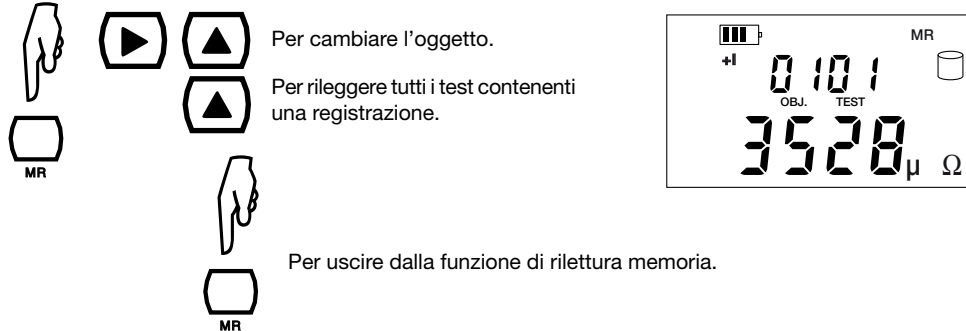

4.3. SOPPRESSIONE MEMORIA

Per sopprimere una registrazione (riletura memoria o no):

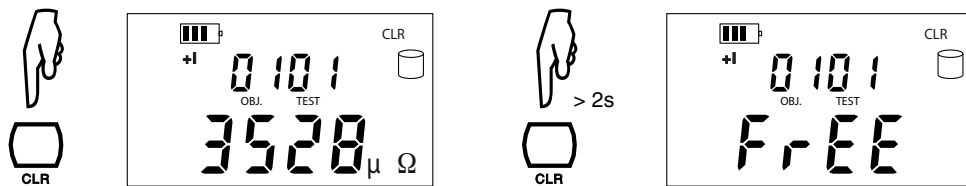

4.4. INFORMAZIONI COMPLEMENTARI

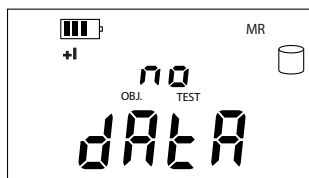

Memoria vuota

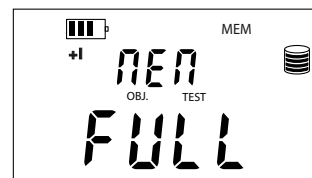

Memoria piena

4.5. REGISTRAZIONE AUTOMATICA

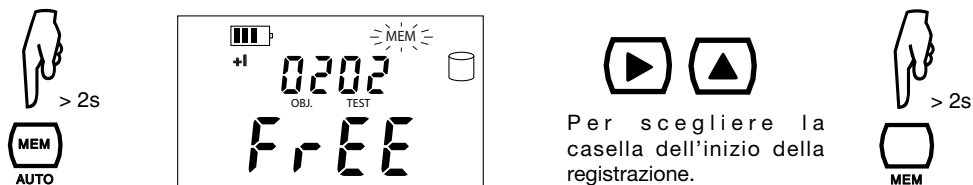

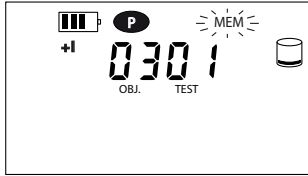

La registrazione automatica viene attivata.

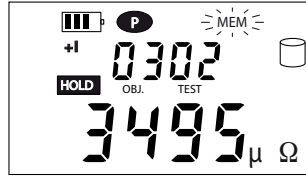

Ad ogni nuova misura, il numero del test viene incrementato e la misura viene registrata.

Per bloccare la registrazione automatica, premere il bottone START/STOP.

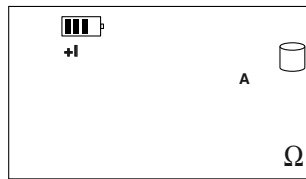

4.6. TRASFERIMENTO DEI DATI SU PC

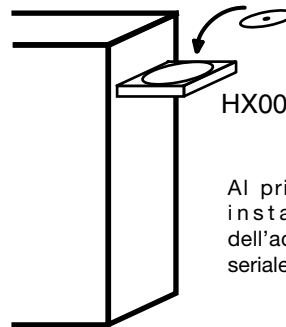
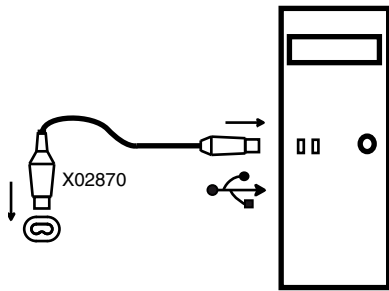

HX0056-Z

Al primo trasferimento, installare il driver dell'adattatore USB/optico seriale (HX0056-Z).

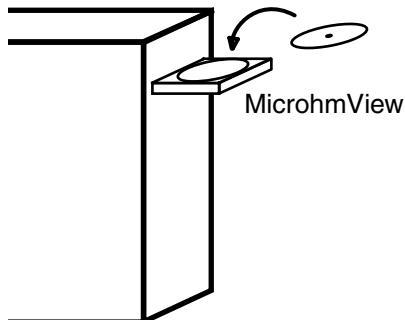

Poi, installare il software applicativo MicrohmView mediante il readme.txt.

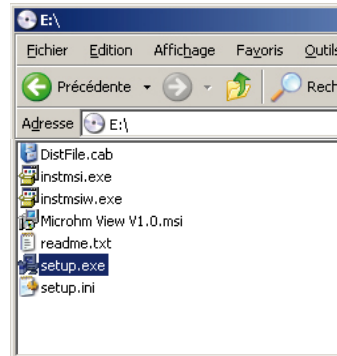

Per utilizzare Microhmview, riferirsi alle istruzioni dell'assistenza.

5. ALTRE FUNZIONI (SET-UP)

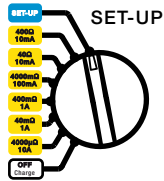

5.1. SOPPRESSIONE COMPLETA DELLA MEMORIA

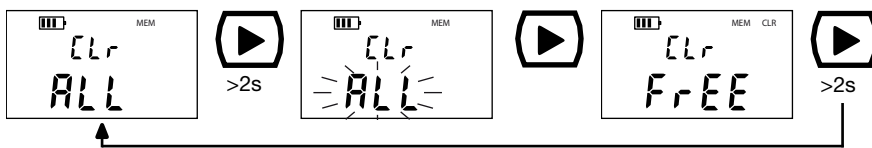

5.2. PROGRAMMAZIONE DELL'ORA

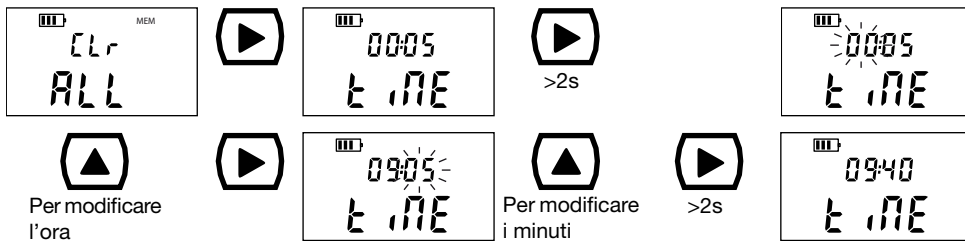

5.3. PROGRAMMAZIONE DELLA DATA

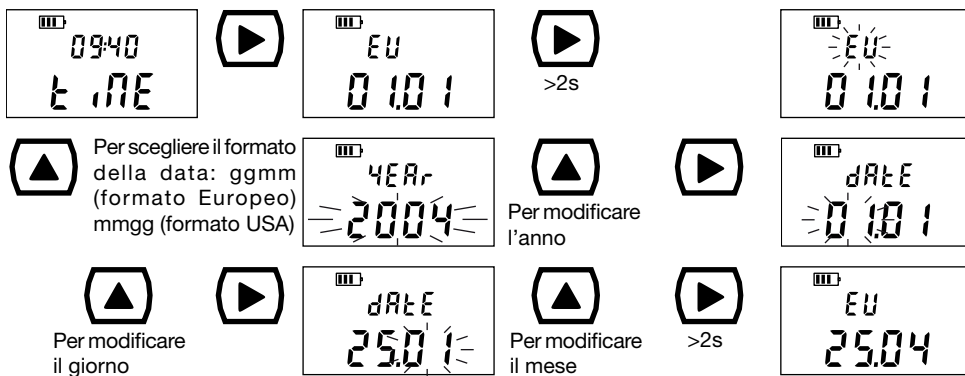

5.4. PROGRAMMAZIONE DEL TEMPO DI BLOCCAGGIO AUTOMATICO

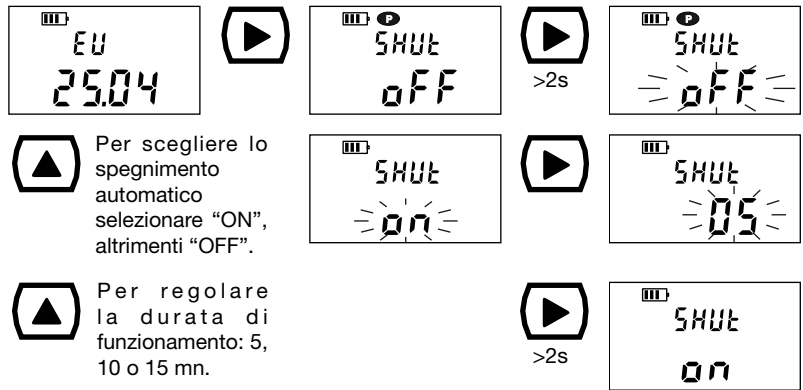

5.5. VISUALIZZAZIONE DEI PARAMETRI INTERNI DELL'APPARECCHIO

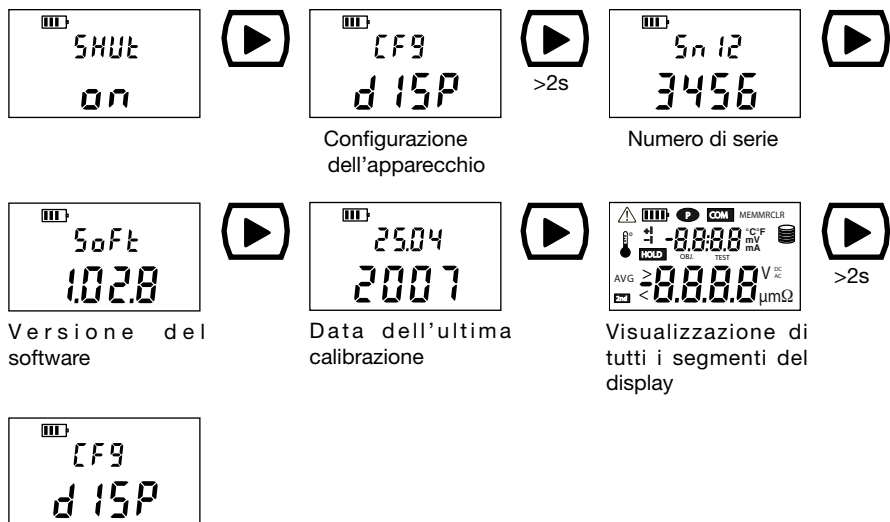

6. CARATTERISTICHE

6.1. CONDIZIONI DI RIFERIMENTO

Grandezze d'influenza	Valori di riferimento
Temperatura	23 ± 3 °C
Umidità relativa	45 a 55 % UR
Tensione d'alimentazione	6 V ± 0,2 V
Tensione esterna presente ai morsetti della resistenza sotto test	nulla
Induttanza della resistenza sotto test	nulla
Campo elettrico	nullo
Campo magnetico	< 40 A/m

6.2. CARATTERISTICHE DELLE MISURE DI RESISTENZA

Nessuna tensione dovrà trovarsi sull'elemento da misurare.

Campo di misura	5 - 3999 $\mu\Omega$	4,00 - 39,99 m Ω	40,0 - 399,9 m Ω	400 - 3999 m Ω	4,00 - 39,99 Ω	40,0 - 399,9 Ω
Risoluzione	1 $\mu\Omega$	10 $\mu\Omega$	100 $\mu\Omega$	1 m Ω	10 m Ω	100 m Ω
Precisione	± 0,25% ± 2 pt					
Corrente di misura	10,2 A ± 2% (1)	1,02 A ± 2%		102 mA ± 2%	10,2 mA ± 2% (2)	
Tensione a vuoto	4 a 6 V					

(1) Con un valore nominale a 10,2 A, la corrente di misura minimale è di 10 A qualunque sia lo stato della batteria.

(2) La corrente vale 10 mA solo fino a 300 Ω . Se la batteria è scarsa, è possibile arrivare fino a 8 mA.

6.3. CARATTERISTICHE DELLE MISURE DI TENSIONE AI MORSETTI DELLA RESISTENZA MISURATA

Campo di misura	0,010 - 3,999 mV	4,00 - 39,99 mV	40,0 - 399,9 mV	0,400 - 3,999 V	4,00 - 4,70 V
Risoluzione	1 μ V	10 μ V	100 μ V	1 mV	10 mV
Precisione	± 0,5% ± 10 pt		± 0,5% ± 1 pt		

6.4. CARATTERISTICHE DELLE MISURE DI TENSIONE AI MORSETTI DELLA RESISTENZA MISURATA

Campo di misura	5,00 – 39,99 mA	40,0 – 399,9 mA	0,400 – 3,999 A	4,00 – 11,00 A
Risoluzione	10 μ A	100 μ A	1 mA	10 mA
Precisione	$\pm 0,5\% \pm 2$ pt	$\pm 0,5\% \pm 1$ pt		

6.5. INFLUENZE SULLA MISURA DI RESISTENZA

Grandezze d'influenza	Limiti del campo d'utilizzo	Variazioni della misura	
		Tipica	Massima
Temperatura	-10 a + 55 °C	0,1 %/10 °C	0,5 %/10 °C + 2pt
Umidità relativa	10 à 85 % UR @ 45°C	0,1 %	0,5 % + 2pt
Alimentazione	5 a 7 V	2 pt	0,2%/ V + 2pt
Reiezione di modo seriale 50/60Hz (1)	$U (AC) = (R \text{ misurata} \times I \text{ misura})$	< 0,2%	2% + 1pt
Reiezione di modo comune in AC 50/60Hz	0 a 50 V AC	> 80 dB	> 60 dB

(1) Esempio: se la resistenza misurata è di 1 m e se la corrente di misura è di 10 A, una tensione alternata di 1 mV eff. in serie con la resistenza da misurare non creerà un errore superiore al 2%.

6.6. ALIMENTAZIONE

L'alimentazione dell'apparecchio viene realizzata da un pack di batterie ricaricabili (tecnologia NiMH 6 V 8,5Ah). Ciò vi permette di disporre di numerosi vantaggi:

- una grande autonomia e una riduzione d'ingombro e di peso,
- la possibilità di ricaricare rapidamente la vostra batteria,
- un effetto memoria molto ridotto: potete ricaricare rapidamente la vostra batteria anche se non è completamente scarica senza diminuire la sua capacità,
- rispetto dell'ambiente: assenza di materiali inquinanti come il piombo o il cadmio.

La tecnologia NiMH permette un numero limitato di cicli di carica/scarica dipendente dalle condizioni d'utilizzo e dalle condizioni di carica. In condizioni ottimali, questo numero di cicli è di 200.

L'apparecchio dispone di 2 modi di carica:

- una carica rapida: la batteria recupera il 90% della sua capacità in 3 ore,
- una carica di manutenzione: questo modo appare quando la batteria è molto debole e alla fine della carica rapida.

L'autonomia è in funzione dei calibri utilizzati

	Numero delle misure (1)
Calibro 10 A	850
Calibro 1 A	3 500
Calibro 100 mA	4 500
Calibro 10 mA	5 000
Apparecchio in standby o fermo	Autonomia: da 4 a 6 mesi

(1) stabilito per misure di una durata di 5 s ogni 25 s.

6.7. CONDIZIONI AMBIENTALI

Utilizzare all'interno o all'esterno

Campo d'utilizzo - 10 a +55 °C 10 al 85 % UR

Stoccaggio (senza batteria) - 40 a +70 °C 10 al 90 % UR

Altitudine < 2000 m

Grado d'inquinamento 2

Per uno stoccaggio di lunga durata (2 anni) con la batteria, occorre rimanere nel campo compreso fra -20 e +30°C e 85% UR altrimenti le caratteristiche della batteria si deteriorano. Per uno stoccaggio di breve durata (1 mese), la temperatura può salire fino a 50°C.

6.8. CARATTERISTICHE COSTRUTTIVE

Dimensioni totali dell'apparecchio (L x l x h): 273 x 247 x 176 mm

Massa: 4,5 kg circa

IP 53 secondo NF EN 60529 (Ed. 92)

IK 04 secondo NF EN 50102 (Ed. 95)

6.9. CONFORMITÀ ALLE NORME INTERNAZIONALI

Sicurezza elettrica secondo EN 61010-1 (Ed. 2, 2001).

Misure secondo la norma EN61557 (Ed. 2 del 2007) parti 1 e 4.

Categorie di sicurezza: categoria di misura III, 50 V rispetto alla terra, 500 V in differenziale fra i morsetti e 300 V cat. Il sull'entrata caricatore.

6.10. COMPATIBILITÀ ELETTROMAGNETICA

- L'apparecchio soddisfa le direttive CEM e DBT necessarie alla marcatura CE e alla norma prodotto EN 61326-1 (Ed. 97) + A1 (Ed. 98)
- Emissione in ambiente residenziale
- Immunità in ambiente industriale

7. MANUTENZIONE

 Per la manutenzione, utilizzate solo i pezzi di ricambio precedentemente specificati. La responsabilità del fabbricante non potrà venire coinvolta in caso d'incidente dovuto a riparazioni non effettuate dal servizio Post-Vendita o da riparatori abilitati.



7.1. VERIFICHE CORRENTI

7.1.1. RICARICA DELLA BATTERIA

 → Ricaricare la batteria (vedasi §2)

 La sostituzione della batteria verrà effettuata da Manumisure o da un riparatore autorizzato da Chauvin Arnoux. Utilizzare solo batterie raccomandate dal costruttore. La sostituzione della batteria non causa la perdita dei dati memorizzati. Occorre invece programmare di nuovo la data e l'ora (vedasi § 5.2 e 5.3).

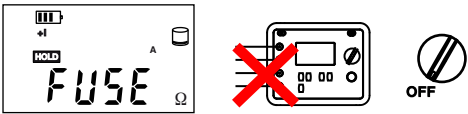
7.1.2. SOSTITUZIONE DEL FUSIBILE

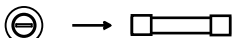
    FF 12,5 A - 500 V - 6,3 x 32 mm - 20 kA

7.1.3. PULIZIA

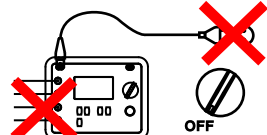
  Utilizzare un panno soffice, leggermente imbevuto d'acqua saponata. Sciacquare con un panno umido e asciugare rapidamente con un panno asciutto oppure aria compressa. Non utilizzare alcol, solventi o idrocarburi.

7.1.4. VERIFICA METROLOGICA

Come tutti gli apparecchi di misura o di prova, è necessaria una verifica periodica.

Vi consigliamo almeno una verifica annuale dell'apparecchio. Per le verifiche e calibrazioni, rivolgetevi ai nostri laboratori di metrologia accreditati (ragguagli ed estremi su domanda), alla filiale Chauvin Arnoux o all'agente del vostro paese.

7.1.5. UPGRADE DEL SOFTWARE DELL'APPARECCHIO

Nell'intento costante di fornire il migliore servizio reso in termini di prestazioni e d'evoluzione tecnica, Chauvin Arnoux vi offre la possibilità di aggiornare il software integrato all'apparecchio (firmware) telescaricando gratuitamente la nuova versione disponibile sul nostro sito Internet.

Per maggiori informazioni vi preghiamo di consultare il nostro sito <http://www.chauvin-arnoux.com> nella rubrica "Spazio Supporto Software".

7.2. RIPARAZIONE

Per le riparazioni sotto e fuori garanzia, rinviare l'apparecchio al vostro distributore.

8. GARANZIA

La nostra garanzia si esercita, salvo stipulazione esplicita, per **dodici mesi** dopo la data di messa a disposizione del materiale. Estratto delle nostre Condizioni Generali di Vendita, comunicate su domanda.

9. PER ORDINARE

C.A 6240 P01.1432.00

Il C.A 6240 viene fornito in una scatola di cartone con una sacca per trasportare i seguenti accessori:
un set di 2 pinze Kelvin 10 A con cavo lungo 3 m,
un filo d'alimentazione rete lungo 2 m,
un cavo di comunicazione ottica/USB,
il software "Microhmview",
5 libretti di funzionamento semplificati,
e il presente libretto di funzionamento in 5 lingue.

9.1. ACCESSORI

filo d'alimentazione rete GB lungo 2 m P01.2952.53
set di 2 punte di contatto doppie P01.1017.82
set di 2 mini- pinze Kelvin P01.1017.83
termoigrometro C.A 846 P01.1563.01Z
cavo di comunicazione ottica / RS P01.2952.52

9.2. PEZZI DI RICAMBIO

partita di 10 fusibili FF 12,5 A - 500 V - 6,3 x 32 mm P01.2970.91
set di 2 pinze Kelvin 10 A con cavo lungo 3 m P01.1017.94
filo d'alimentazione rete 2P EURO lungo 2 m P01.2951.74
sacca da trasporto standard P01.2980.66
cavo di comunicazione ottica / USB HX0056-Z

ESPAÑOL

⚠ ¡ATENCIÓN, riesgo de PELIGRO! Consultar el manual de instrucciones antes de utilizar el aparato.

En este manual de instrucciones, las instrucciones precedidas de este símbolo, si no se respetan o realizan correctamente, pueden ocasionar un accidente corporal o dañar el aparato y las instalaciones.

☐ Aparato totalmente protegido mediante doble aislamiento o aislamiento reforzado.

♻ El contenedor de basura tachado significa que, en la Unión Europea, el producto deberá ser objeto de una recogida selectiva de los residuos para el reciclado de los aparatos eléctricos y electrónicos de conformidad con la directiva WEEE 2002/96/CE.

⏏ Borna de tierra.

Definición de las categorías de medida:

- La categoría de medida III corresponde a las medidas realizadas en la instalación del edificio.
- La categoría de medida II corresponde a las medidas realizadas en los circuitos directamente conectados a la instalación de baja tensión.
- La categoría de medida I corresponde a las medidas realizadas en los circuitos no conectados directamente a la red.

Usted acaba de adquirir un **micróhmetro C.A 6240** y le agradecemos su confianza. Para obtener el mejor servicio con su aparato:

- lea detenidamente el presente manual de instrucciones
- respete las precauciones de uso

Pegue una de las 5 etiquetas de características entregadas en el interior del embalaje del equipo, elija su idioma.

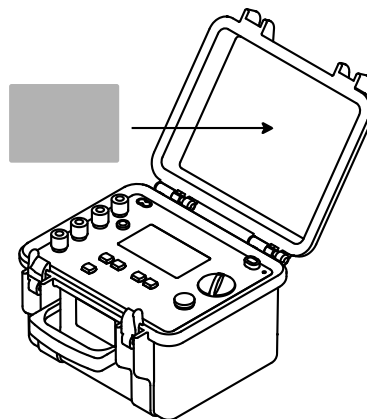

⚠ PRECAUCIONES DE USO ⚠

Este aparato está protegido contra tensiones accidentales que no excedan 50 V respecto a la tierra en categoría de medida III. La protección asegurada por el aparato puede verse comprometida si este se utiliza de una forma no especificada por el fabricante.



No utilizar en conductores susceptibles de estar conectados a la red o en conductores de tierra no desconectados.

Comprobar que el interruptor esté en la posición OFF antes de conectar con la red para recargar la batería del aparato.

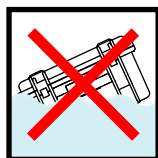
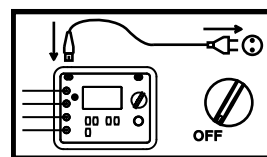

No sumergir el micróhmetro C.A 6240.

Utilizar accesorios de conexión cuya categoría de sobretensión y tensión de servicio sean superiores o iguales a las del aparato de medida (50 V Cat III). Utilizar sólo accesorios que cumplan con las normas de seguridad (IEC 61010-2-031).

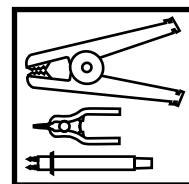

Cualquier operación de reparación o de verificación metrológica debe realizarse por un personal competente y autorizado.

ÍNDICE

1. PRESENTACIÓN	86
2. CARGA DE LA BATERÍA	88
3. MEDIDA DE LA RESISTENCIA	89
3.1. Medida de muy bajo valor.....	90
3.2. Medidas repetitivas	91
3.3. Mensajes de error.....	91
4. MEMORIZACIÓN DE LOS RESULTADOS	93
4.1 Memorización	93
4.2. Lectura de la memoria	94
4.3. Borrado de la memoria.....	94
4.4. Información complementaria	94
4.5. Registro automático	94
4.6. Transferencia de los datos al PC	95
5. OTRAS FUNCIONES (SET-UP)	96
5.1. Borrado completo de la memoria.....	96
5.2. Programación de la hora.....	96
5.3. Programación de la fecha	96
5.4. Programación del tiempo de parada automática	97
5.5. Visualización de los parámetros internos del aparato.....	97
6. CARACTERÍSTICAS	98
6.1. Condiciones de referencia	98
6.2. Características de las medidas de la resistencia	98
6.3. Características de las medidas de tensión en los terminales de la resistencia medida..	98
6.4. Características de las medidas de la corriente que circula en la resistencia medida ..	99
6.5. Influencias en la medida de la resistencia	99
6.6. Alimentación.....	99
6.7. Condiciones de entorno.....	100
6.8. Características constructivas	100
6.9. Conformidad con las normas internacionales	100
6.10. Compatibilidad electromagnética.....	100
7. MANTENIMIENTO	101
7.1. Mantenimiento preventivo	101
7.2. Reparación.....	101
8. GARANTÍA	102
9. PARA PEDIDOS	102
9.1. Accesorios	102
9.2. Piezas de repuesto.....	102

1. PRESENTACIÓN

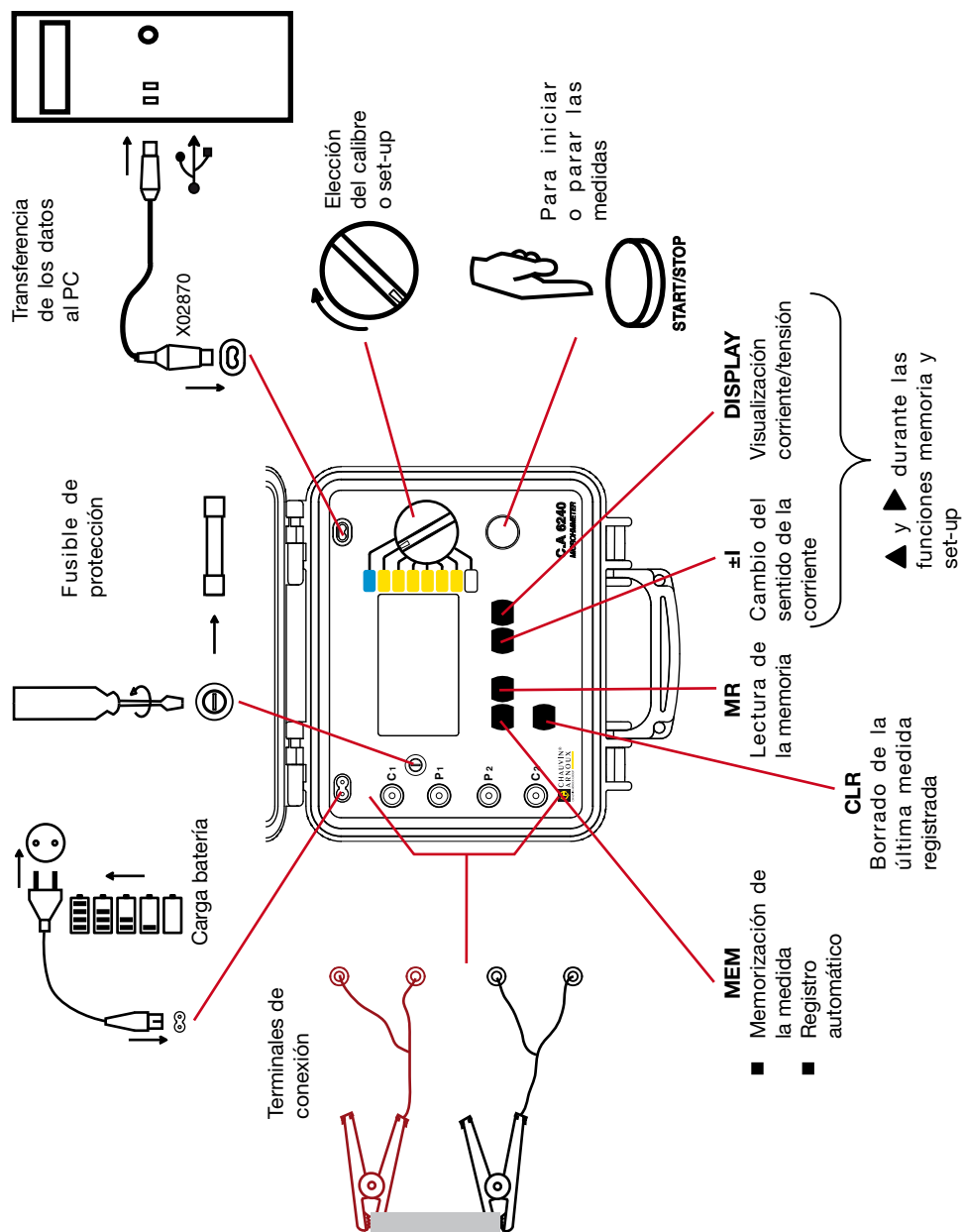

El micróhmetro C.A 6240 es un aparato de medida portátil que se usa para medir valores muy bajos de resistencias. Se presenta en una carcasa robusta y estanca. Está alimentado por una batería recargable con cargador integrado.

Funciones de medida : resistencia

P u e s t a e n : interruptor de 8 posiciones, teclado 5 teclas y 1 botón START/STOP funcionamiento

Visualización : pantalla LCD 100 x 57 mm, retroiluminada, con 2 niveles de visualización digital simultáneos

Representación del visualizador

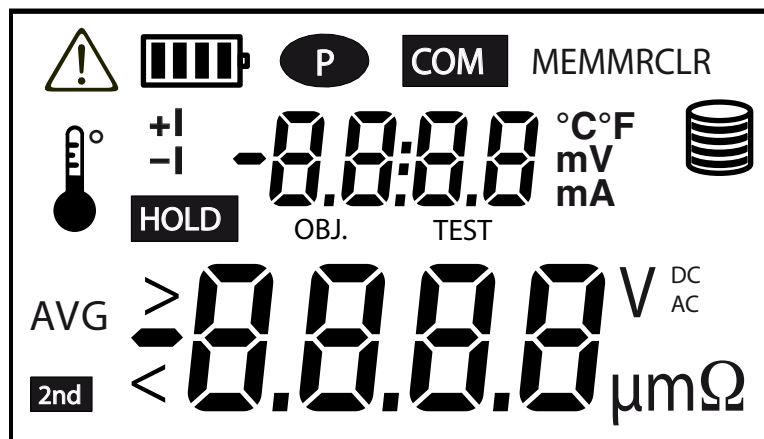

indica un parpadeo

2. CARGA DE LA BATERÍA

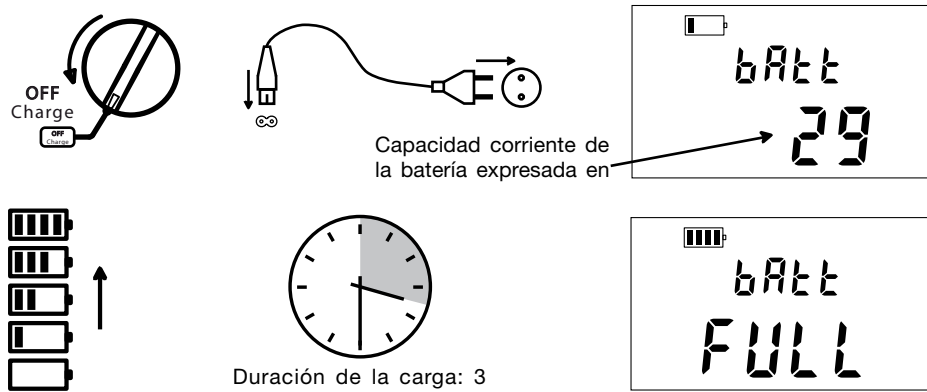

Empezar por cargar completamente la batería antes de la primera utilización.

En el calibre 10 A, la autonomía es de aproximadamente 1 h 20. Es pues preferible cargar la batería antes de emprender una campaña de medidas. La carga debe realizarse entre 0 y 40°C.

La autonomía del aparato depende del calibre. Para visualizarla (antes de realizar la medida):

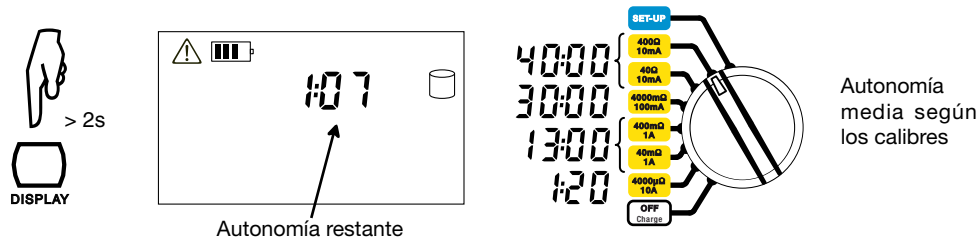

Después de un almacenamiento de larga duración, puede que la batería esté completamente descargada. En este caso, la primera carga puede durar varias horas. La capacidad de la batería y por consiguiente la autonomía del aparato serán menores. La batería recobrará su capacidad inicial después de 5 ciclos de recarga.

3. MEDIDA DE LA RESISTENCIA

1) Conectar los 2 cables a los 4 terminales de medida y las 2 pinzas Kelvin al objeto que va a probar. Este último debe estar apagado.

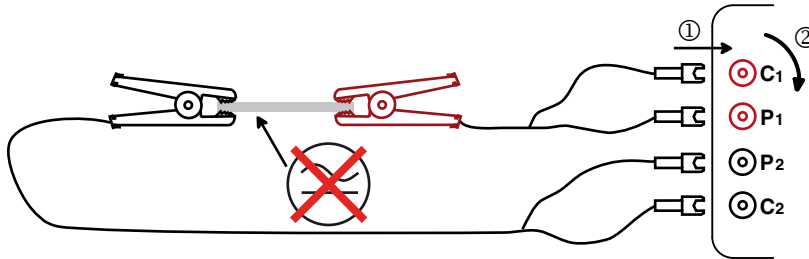

2) Poner el interruptor en la posición $400\Omega - 10\text{ mA}$.

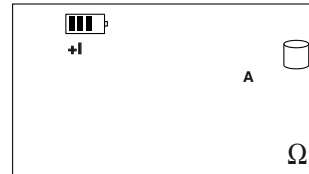
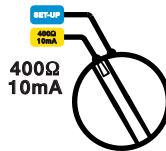

3) Iniciar la medida pulsando el botón START/STOP.

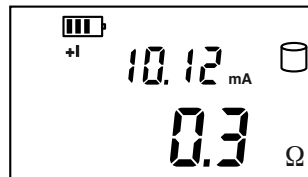

Si la medida es demasiado baja, girar entonces el interruptor hacia el calibre anterior y volver a ejecutar la medida. Seguir hasta que la visualización sea de al menos 3 cifras.

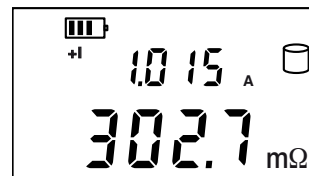
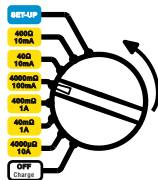

4) Pulsar de nuevo el botón START/STOP para parar la medida...

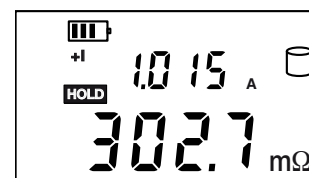

...o desconectar una de las 2 pinzas.

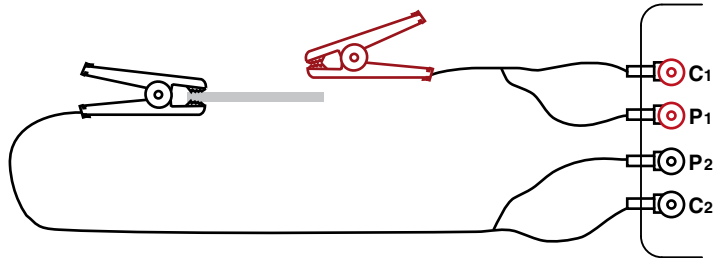

En los dos casos, se visualiza la última medida realizada así como el símbolo **HOLD**

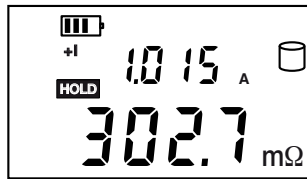

Si se para la medida por la desconexión de una pinza, basta con volver a conectar las pinzas a un nuevo objeto para iniciar una nueva medida, sin tener que pulsar la tecla START/STOP.

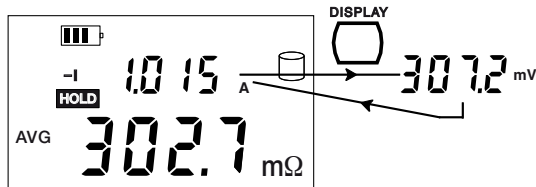

Para visualizar la tensión en los terminales de la resistencia en vez de la corriente de medida, pulsar la tecla DISPLAY.

3.1. MEDIDA DE MUY BAJO VALOR

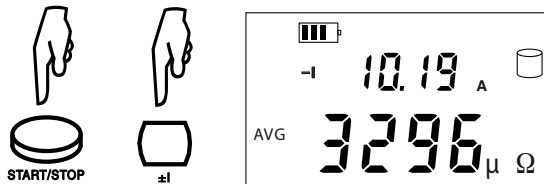

Invertir el sentido de la corriente pulsando la tecla ±I, y se visualiza en el aparato el promedio:

$$R_{AVG} = \frac{R(+I) + R(-I)}{2}$$

Esto permite eliminar los efectos de los termopares.

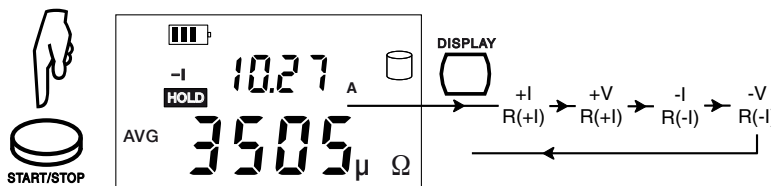

Para visualizar los valores R(+I) y R(-I), pulsar la tecla DISPLAY.

3.2. MEDIDAS REPETITIVAS

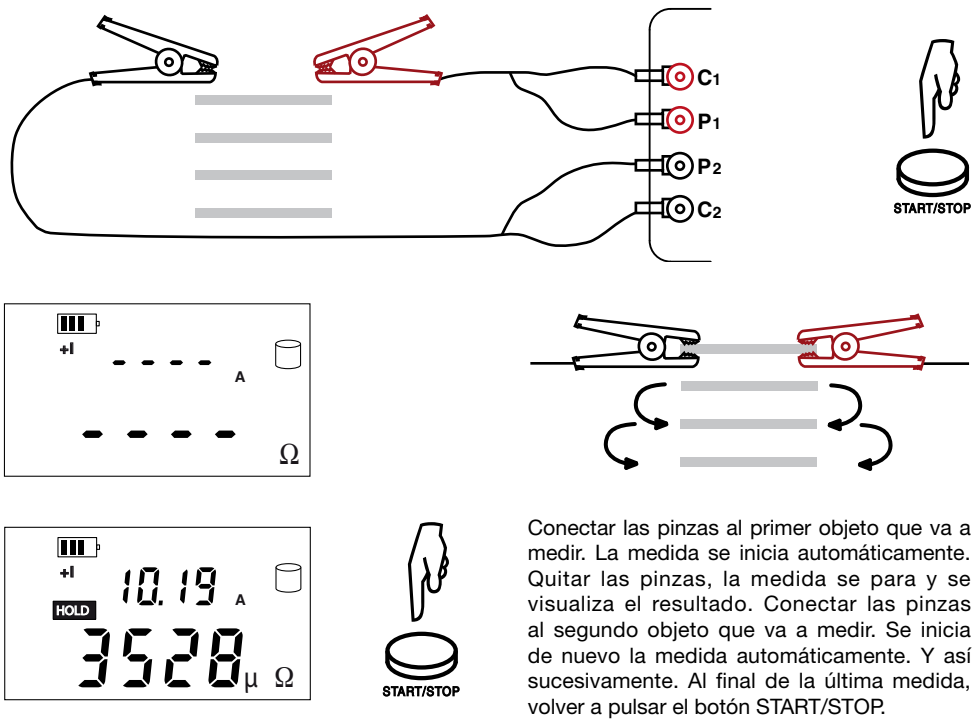

3.3. MENSAJES DE ERROR

3.3.1. PRESENCIA DE UNA TENSIÓN ⚠

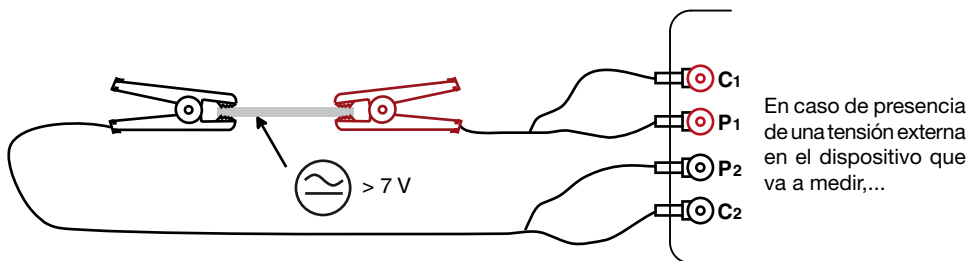

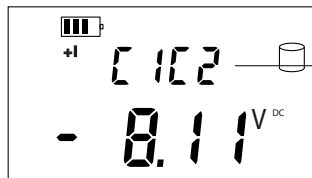

...pulsar el botón START/STOP no sirve de nada, la medida es imposible. Suprimir la tensión para realizar la medida.

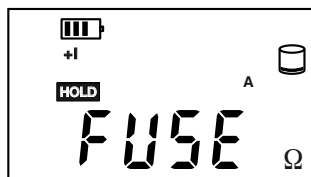
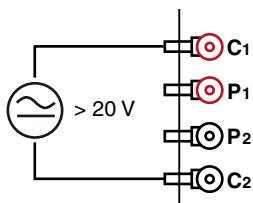

Si se aplica una tensión superior a 20 V entre los terminales C1 y C2, se destruye el fusible ubicado en el frontal del aparato y se tiene que sustituir (ver § 7.1.2)

3.3.2. EXCESO DE CALIBRE

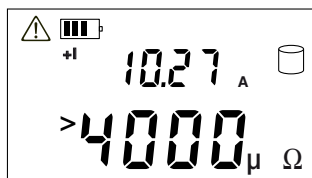

Si el aparato indica un exceso de calibre (símbolo >), girar entonces el interruptor hacia el siguiente calibre, y volver a iniciar la medida. Seguir hasta que el mensaje de exceso de calibre no se visualice más.

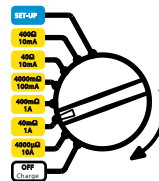

3.3.3. MEDIDA RUIDOSA

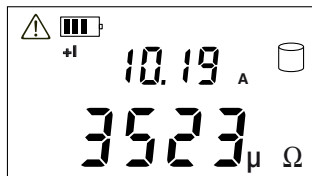

El símbolo ⚠ señala que la medida es ruidosa y que no se garantiza la precisión de la medida.

3.3.4 CALENTAMIENTO EXCESIVO

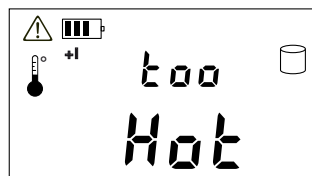

Si una medida con el calibre 10 A dura varios minutos, se produce un calentamiento interno demasiado importante que prohíbe cualquier medida. Hay que esperar que se enfríe el aparato para volver a realizar

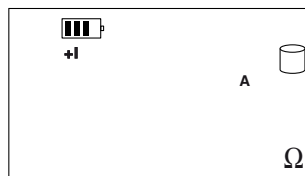

4. MEMORIZACIÓN DE LOS RESULTADOS

El almacenamiento de los datos se organiza en objetos (OBJ.), cada uno pudiendo contener varias pruebas (TEST). OBJ. corresponde al objeto probado y cada prueba corresponde a una medida realizada a este objeto. El aparato puede almacenar 100 medidas.

4.1 MEMORIZACIÓN

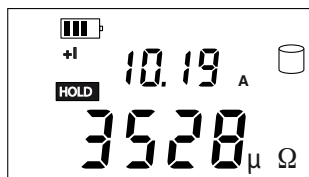

Una vez terminada la medida, se puede guardar. Pulsar la tecla MEM.



El aparato propone la primera ubicación en la memoria libre. Si le conviene, pulse prolongadamente la tecla MEM.

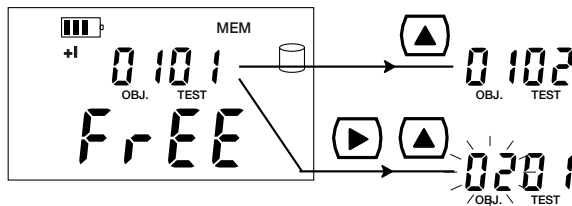
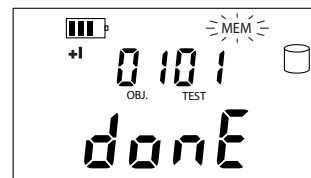
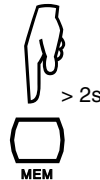

Para modificar el número de la prueba o del objeto, utilizar las flechas.

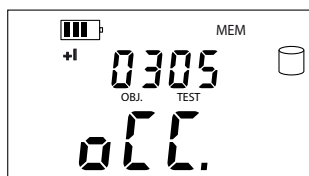

Si la ubicación seleccionada ya está ocupada, lo señala el aparato. Pero es posible sustituir la antigua medida por la nueva.

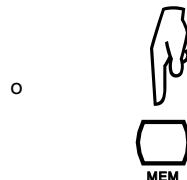
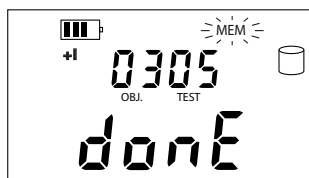
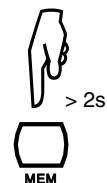

Para salir de la función sin que se registre nada, pulsar la tecla MEM.

4.2. LECTURA DE LA MEMORIA

Ante todo, parar la medida pulsando el botón START/STOP.

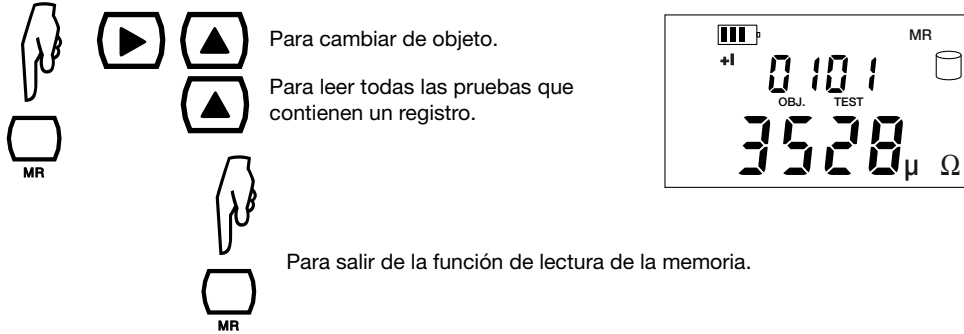

4.3. BORRADO DE LA MEMORIA

Para borrar un registro (lectura de la memoria o no):

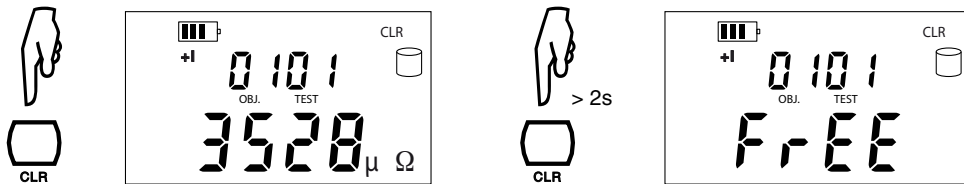

Con las flechas, seleccionar la prueba que va a suprimir.
El borrado completo de la memoria se describe en el párrafo 5.1.

4.4. INFORMACIÓN COMPLEMENTARIA

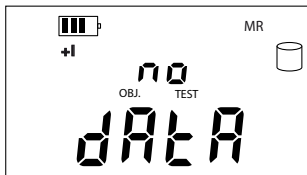

Memoria vacía

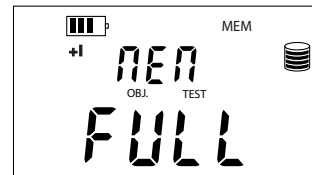

Memoria llena

4.5. REGISTRO AUTOMÁTICO

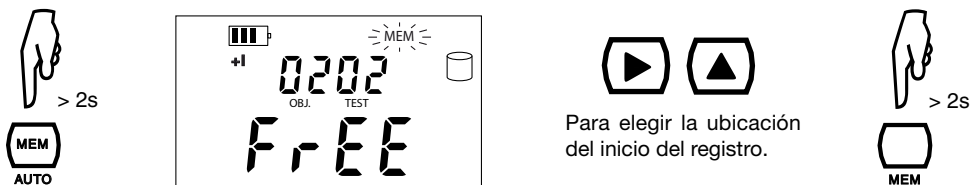

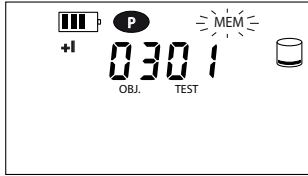

El registro automático está activado.

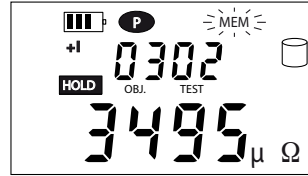

A cada nueva medida, el número de la prueba se incrementa y la medida se registra.

Parar el registro automático, pulsar el botón START/STOP.

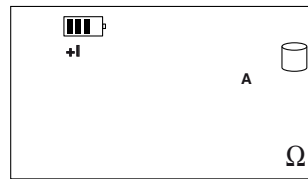

4.6. TRANSFERENCIA DE LOS DATOS AL PC

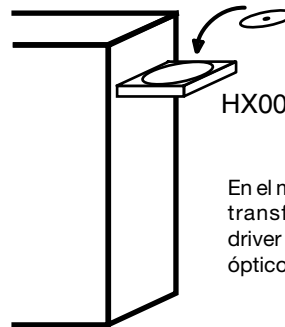
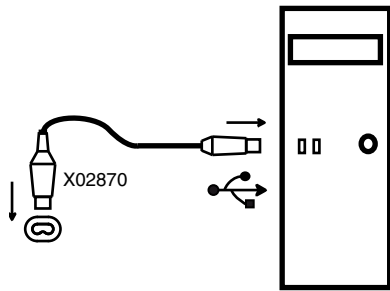

HX0056-Z

En el momento de la primera transferencia, instalar el driver del adaptador USB / óptico serie (HX0056-Z).

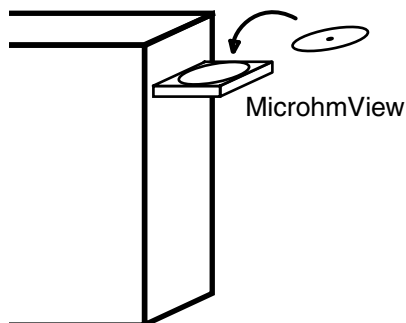

Luego, instalar el software de aplicación MicrohmView con ayuda de readme.txt.

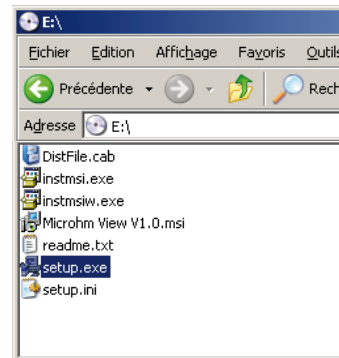

Para utilizar Microhmview, remitirse a la ayuda.

5. OTRAS FUNCIONES (SET-UP)

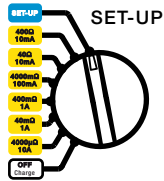

5.1. BORRADO COMPLETO DE LA MEMORIA

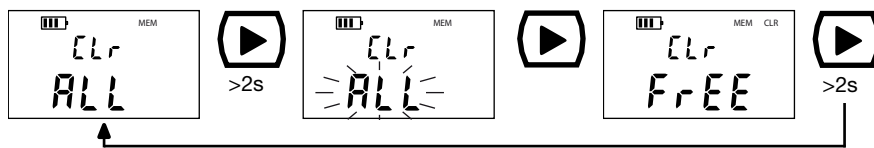

5.2. PROGRAMACIÓN DE LA HORA



5.3. PROGRAMACIÓN DE LA FECHA



5.4. PROGRAMACIÓN DEL TIEMPO DE PARADA AUTOMÁTICA

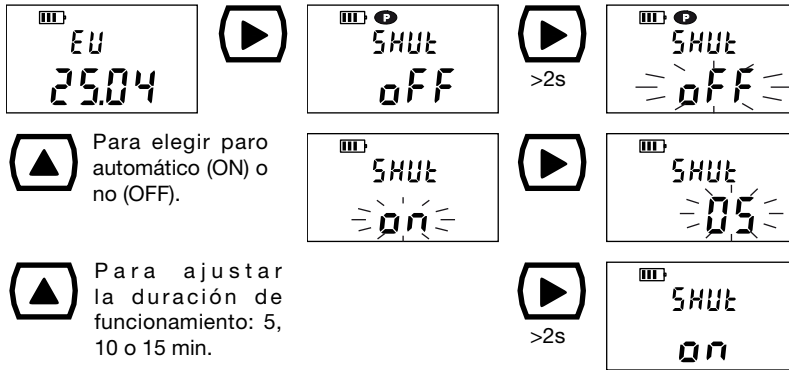

5.5. VISUALIZACIÓN DE LOS PARÁMETROS INTERNOS DEL APARATO

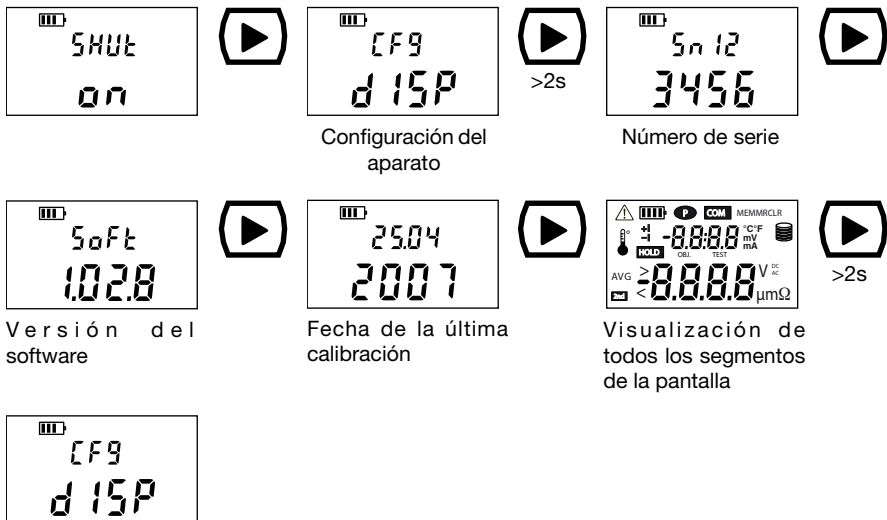

6. CARACTERÍSTICAS

6.1. CONDICIONES DE REFERENCIA

Magnitudes de influencia	Valores de referencia
Temperatura	23 ± 3 °C
Humedad relativa	de 45 a 55 % HR
Tensión de alimentación	6 V ± 0,2 V
Tensión externa presente en los bornes de la resistencia bajo prueba	nula
Inductancia de la resistencia bajo prueba	nula
Campo eléctrico	nulo
Campo magnético	< 40 A/m

6.2. CARACTERÍSTICAS DE LAS MEDIDAS DE LA RESISTENCIA

Ninguna tensión debe estar presente en el elemento que va a medir.

Campo de medida	5 - 3999 $\mu\Omega$	4,00 - 39,99 m Ω	40,0 - 399,9 m Ω	400 - 3999 m Ω	4,00 - 39,99 Ω	40,0 - 399,9 Ω
Resolución	1 $\mu\Omega$	10 $\mu\Omega$	100 $\mu\Omega$	1 m Ω	10 m Ω	100 m Ω
Precisión	± 0,25% ± 2 pt					
Corriente de medida	10,2 A ± 2% (1)	1,02 A ± 2%		102 mA ± 2%	10,2 mA ± 2% (2)	
Tensión en vacío	de 4 a 6 V					

(1) Con un valor nominal de 10,2 A, la corriente de medida mínima es de 10 A cualquiera que sea el estado de la batería.

(2) La corriente vale 10 mA sólo hasta 300 Ω . Si la batería está baja, puede bajar hasta 8 mA.

6.3. CARACTERÍSTICAS DE LAS MEDIDAS DE TENSIÓN EN LOS TERMINALES DE LA RESISTENCIA MEDIDA

Campo de medida	0,010 - 3,999 mV	4,00 - 39,99 mV	40,0 - 399,9 mV	0,400 - 3,999 V	4,00 - 4,70 V
Resolución	1 μ V	10 μ V	100 μ V	1 mV	10 mV
Precisión	± 0,5% ± 10 pt	± 0,5% ± 1 pt			

6.4. CARACTERÍSTICAS DE LAS MEDIDAS DE LA CORRIENTE QUE CIRCULA EN LA RESISTENCIA MEDIDA

Campo de medida	5,00 – 39,99 mA	40,0 – 399,9 mA	0,400 – 3,999 A	4,00 – 11,00 A
Resolución	10 μ A	100 μ A	1 mA	10 mA
Precisión	$\pm 0,5\% \pm 2$ pt	$\pm 0,5\% \pm 1$ pt		

6.5. INFLUENCIAS EN LA MEDIDA DE LA RESISTENCIA

Magnitudes de influencia	Limites del campo de utilización	Variación de la medida	
		Típica	Máxima
Temperatura	de -10 a + 55 °C	0,1 %/10 °C	0,5 %/10 °C + 2pt
Humedad relativa	de 10 a 85 % HR @ 45°C	0,1 %	0,5 % + 2pt
Tensión de alimentación	de 5 a 7 V	2 pt	0,2%/ V + 2pt
Rechazo en modo serie 50/60Hz (1)	$U (AC) = (R \text{ medida} \times I \text{ medida})$	< 0,2%	2% + 1pt
Rechazo en modo común en AC 50/60 Hz	de 0 a 50 V AC	> 80 dB	> 60 dB

(1) Ejemplo. Si la resistencia medida es de 1 m Ω y que la corriente de medida es de 10 A, una tensión alternativa de 1 mV ef. en serie con la resistencia por medir no creará un error superior a un 2%.

6.6. ALIMENTACIÓN

La alimentación del aparato se realiza mediante varias baterías recargables de tecnología NiMH 6V 8,5Ah. Esto le permite disponer de numerosas ventajas:

- una gran autonomía para un volumen y un peso limitado,
- la posibilidad de recargar rápidamente su batería,
- un efecto memoria muy reducido: puede recargar rápidamente su batería aunque no esté completamente descargada sin disminuir su capacidad,
- respeto del medio ambiente: ausencia de materiales contaminantes como el plomo o el cadmio.

La tecnología NiMH permite un número limitado de ciclo de carga-descarga que depende de las condiciones de utilización y de las condiciones de carga. En condiciones óptimas, este número de ciclos es de 200.

El aparato dispone de 2 modos de cargas:

- una carga rápida: la batería recobra el 90% de su capacidad en 3 h;
- una carga de mantenimiento: este modo aparece cuando la batería está muy baja y al final de la carga rápida.

La autonomía depende de los calibres utilizados

	Número de medidas (1)
Calibre 10 A	850
Calibre 1 A	3 500
Calibre 100 mA	4 500
Calibre 10 mA	5 000
Aparato en modo suspensión o apagado	autonomía de 4 a 6 meses

(1) establecido para medidas de una duración de 5 s todos los 25 s.

6.7. CONDICIONES DE ENTORNO

Utilización en interior y en exterior.

Campo de utilización de - 10 a +55 °C de 10 a 85 % HR

Almacenamiento (sin batería) de - 40 a +70 °C de 10 a 90 % HR

Altitud < 2000 m

Grado de contaminación 2

Para un almacenamiento de larga duración (2 años) con la batería, no se tiene que salir del rango de -20 a +30°C y 85% HR sino las características de la batería se deterioran. Para un almacenamiento de corta duración (1 mes), la temperatura puede subir hasta 50°C.

6.8. CARACTERÍSTICAS CONSTRUCTIVAS

Dimensiones totales del aparato (L x An x Al): 273 x 247 x 176 mm

Peso: aproximadamente 4,5 kg

IP 53 según NF EN 60529 (Ed. 92)

IK 04 según NF EN 50102 (Ed. 95)

6.9. CONFORMIDAD CON LAS NORMAS INTERNACIONALES

Seguridad eléctrica según EN 61010-1 (Ed. 2 de 2001).

Medida según EN 61557 (Ed. 2 de 2007) parte 1 y 4.

Características asignadas: categoría de medida III, 50 V respecto a la tierra, 500 V en diferencial entre los terminales y 300 V cat II en la entrada del cargador.

6.10. COMPATIBILIDAD ELECTROMAGNÉTICA

El aparato cumple con las directivas CEM y DBT necesarias para el marcado CE y la norma producto EN 61326-1 (Ed. 97) + A1 (Ed. 98)

- Emisión en ámbito residencial
- Inmunidad en ámbito industrial

7. MANTENIMIENTO

 Para el mantenimiento, sólo use las piezas de repuesto especificadas. El fabricante no se hará responsable de cualquier accidente que pudiera derivarse de una reparación no realizada por su servicio postventa o por reparadores autorizados.

7.1. MANTENIMIENTO PREVENTIVO

7.1.1. RECARGA DE LA BATERÍA

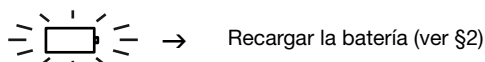

 La sustitución de la batería deberá realizarse por Manuresure o un reparador autorizado por Chauvin Arnoux. No montar otra batería que no sea la recomendada por el fabricante. El cambio de la batería no ocasiona la pérdida de los datos memorizados. En cambio, se tiene que volver a programar la fecha y la hora (ver § 5.2 y 5.3).

7.1.2. SUSTITUCIÓN DEL FUSIBLE

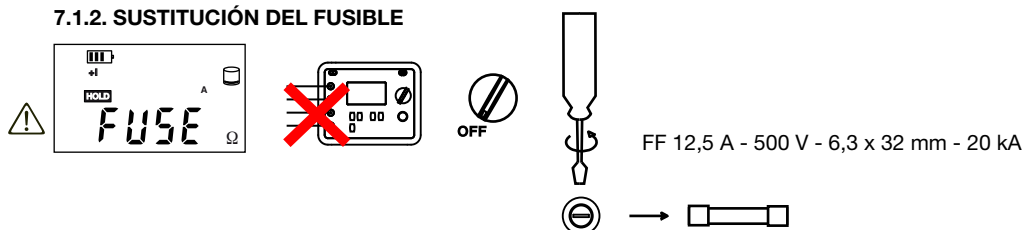

7.1.3. LIMPIEZA

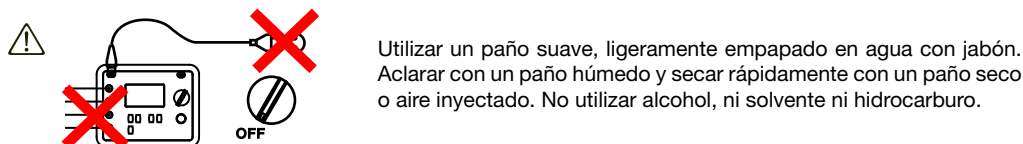

7.1.4. VERIFICACIÓN METROLÓGICA

Al igual que todos los aparatos de medida o de prueba, una verificación periódica es necesaria. Les aconsejamos por lo menos una verificación anual de este aparato. Para las verificaciones y calibraciones, contacte con nuestros laboratorios de metrología acreditados (información y datos a petición), con la filial Chauvin Arnoux o con el agente de su país.

7.1.5. ACTUALIZACIÓN DEL SOFTWARE DEL APARATO

Con el deseo permanente de proporcionar el mejor servicio prestado en rendimientos y evolución técnica, Chauvin Arnoux le ofrece la posibilidad de actualizar el software integrado en el aparato (firmware) descargando gratuitamente la nueva versión disponible en nuestro sitio Internet.

Para obtener más información, consulte nuestro sitio Web <http://www.chauvin-arnoux.com> en la sección "Espacio Soporte Software".

7.2. REPARACIÓN

Para las reparaciones bajo garantía y fuera de garantía, devuelva el aparato a su distribuidor.

8. GARANTÍA

Nuestra garantía tiene validez, salvo estipulación expresa, durante **doce meses** a partir de la fecha de puesta a disposición del material. Extracto de nuestras Condiciones Generales de Venta, comunicadas a quien las solicite.

9. PARA PEDIDOS

C.A 6240 P01.1432.00

El C.A 6240 se suministra en una caja de cartón con una bolsa de transporte de accesorios que contiene:

un juego de 2 pinzas Kelvin 10 A con cable de 3 m,
un cable de alimentación de red de 2 m,
un cable de comunicación óptico / USB,
el software "Microhmview",
5 manuales de instrucciones simplificados,
y este manual de instrucciones en 5 idiomas.

9.1. ACCESORIOS

cable de alimentación de red GB de 2 m P01.2952.53
juego de 2 puntas de prueba dobles P01.1017.82
juego de 2 mini-pinzas Kelvin P01.1017.83
termohigrómetro C.A 846 P01.1563.01Z
cable de comunicación óptico / RS P01.2952.52

9.2. PIEZAS DE REPUESTO

lote de 10 fusibles FF 12,5 A – 500 V - 6,3 x 32 mm P01.2970.91
juego de 2 pinzas Kelvin 10 A con cable de 3 m P01.1017.94
cable de alimentación de red 2P EURO de 2 m P01.2951.74
bolsa de transporte estándar P01.2980.66
cable de comunicación óptico / USB HX0056-Z



07 - 2007

Code 692008A00 - Ed. 1

DEUTSCHLAND - Chauvin Arnoux GmbH
Straßburger Str. 34 - 77694 Kehl / Rhein
Tel: (07851) 99 26-0 - Fax: (07851) 99 26-60

ESPAÑA - Chauvin Arnoux Ibérica SA
C/ Roger de Flor N° 293, Planta 1- 08025 Barcelona
Tel: 93 459 08 11 - Fax: 93 459 14 43

ITALIA - Amra SpA
Via Sant'Ambrogio, 23/25 - 20050 Bareggia di Mache rio (MI)
Tel: 039 245 75 45 - Fax: 039 481 561

ÖSTERREICH - Chauvin Arnoux Ges.m.b.H
Slamastrasse 29/3 - 1230 Wien
Tel: 01 61 61 961-0 - Fax: 01 61 61 961-61

SCANDINAVIA - CA Mätssystem AB
Box 4501 - SE 18304 TÄBY
Tel: +46 8 50 52 68 00 - Fax: +46 8 50 52 68 10

SCHWEIZ - Chauvin Arnoux AG
Einsiedlerstraße 535 - 8810 Horgen
Tel: 044 727 75 55 - Fax: 044 727 75 56

UNITED KINGDOM - Chauvin Arnoux Ltd
Waldeck House - Waldeck Road - Maidenhead SL6 8BR
Tel: 01628 788 888 - Fax: 01628 28 099

MIDDLE EAST - Chauvin Arnoux Middle East
P.O. BOX 60-154 - 1241 2020 JAL EL DIB (Beirut) - LEBANON
Tel: (01) 89 04 25 - Fax: (01) 89 04 24

CHINA - Shanghai Pu-Jiang - Enerdis Instruments Co. Ltd
3 F, 3 rd Building - N° 381 Xiang De Road - 200081 SHANGHAI
Tel: +86 21 65 21 51 96 - Fax: +86 21 65 21 61 07

USA - Chauvin Arnoux Inc - d.b.a AEMC Instruments
200 Foxborough Blvd. - Foxborough - MA 02035
Tel: (508) 698-2115 - Fax: (508) 698-2118

<http://www.chauvin-arnoux.com>

190, rue Championnet - 75876 PARIS Cedex 18 - FRANCE
Tél. : +33 1 44 85 44 85 - Fax : +33 1 46 27 73 89 - info@chauvin-arnoux.fr
Export : Tél. : +33 1 44 85 44 86 - Fax : +33 1 46 27 95 59 - export@chauvin-arnoux.fr