

HANDSCOPE

Portable Oscilloscopes

OX 5022: 2 channels, 20 MHz

OX 5042: 2 channels, 40 MHz

Operating Instructions



metrix Pôle Test et Mesure de CHAUVIN-ARNOUX
Parc des Glaisins - 6, avenue du Pré de Challes
F - 74940 ANNECY-LE-VIEUX - FRANCE
Tel. +33 (0)4.50.64.22.22 - Fax +33 (0)4.50.64.22.00

Contents

General instructions	Chapter I
General	3
Software update	6
"Integrated Help function"	6
Description of the instrument	Chapter II
Presentation.....	7
Views	10
Terminals	11
Front panel.....	14
"Oscilloscope" Mode	Chapter III
The keys	15
The display.....	16
The menus	20
<i>Channel "A" or "B" menu</i>	<i>23</i>
<i>"M" Math menu.....</i>	<i>27</i>
<i>"Trigger" menu.....</i>	<i>31</i>
<i>"ACQ" Acquisition menu.....</i>	<i>36</i>
<i>"Meas" Measurement menu</i>	<i>40</i>
<i>"M" Memory menu.....</i>	<i>43</i>
<i>"Tool" utility menu.....</i>	<i>46</i>
<i>"?" Key Help.....</i>	<i>47</i>
"Multimeter" mode"	Chapter IV
The keys	48
The display.....	49
<i>"Meas" Measurement menu</i>	<i>51</i>
<i>Channel "A" or "B" menu</i>	<i>54</i>
<i>"M" Memory menu.....</i>	<i>56</i>
"Harmonic analyser" mode	Chapter V
The keys	57
The display.....	58
<i>Channel "A" or "B" menu</i>	<i>60</i>
<i>"ACQ" Acquisition menu.....</i>	<i>61</i>
<i>"M" Memory menu.....</i>	<i>62</i>
Remote programming	Chapter VI
.....	63
Technical specifications	Chapter VII
.....	65
General specifications - Mechanical specifications	Chapter VIII
.....	73
Supplies	Chapter IX
.....	74

General

Introduction



Congratulations! You have just purchased a digital portable **oscilloscope**. We thank you for your confidence in the quality of our products.

The instrument line to which it belongs is composed of the following models:

OX 5022	colour screen	2 channels	20 MHz	scale 50 MS/s
OX 5042	colour screen	2 channels	40 MHz	scale 50 MS/s

This oscilloscope also has the following modes:

- **multimeter**
- **"harmonic" analyser**

It is compliant with the safety standard IEC 61010-1 + IEC 61010-2-30, double insulation, relating to electronic measurement instruments.

In order to obtain the best results please read these instructions carefully and follow the precautions for use.

Failure to respect the warnings and/or usage instructions may damage the appliance and can be dangerous for the user.

Eco-Design



Chauvin-Arnoux has adopted an Eco-Design approach in order to design this appliance. Analysis of the complete lifecycle has enabled us to control and optimize the effects of the product on the environment. In particular this appliance exceeds regulation requirements with respect to recycling and reuse.

Precautions and safety measures



The operator and/or the responsible authority must carefully read and correctly understand the different precautions for use.

If you use this instrument in an unspecified manner, the protection it ensures can be compromised, thus putting you in danger.

- This instrument is designed for use:
 - indoors
 - in a level 2 pollution environment
 - at an altitude below 2000 m
 - at a temperature between 0° C and 40° C
 - with a relative humidity of less than 80% up to 35° C.
- The safety of all systems including the appliance is the responsibility of the assembler of the system.
- It can be used for measurements on 600 V CAT III circuits, relative to the earth.

before use

- Before each use, check the state of the insulation on the cables, boxes, sensors and accessories. Any element on which the insulation is damaged (even partially) must be taken out of service for repair or disposal.
- Respect the environmental and storage conditions.
- External power supply: it must be connected to the instrument and to the network (98 to 264 VAC).

General (cont'd)

during use

- The power supply to the instrument is fitted with an automatically resettable electrical protection after disappearance of the fault.
- As a safety measure, only use the appropriate cables and accessories delivered with the appliance or approved by the manufacturer.
- It is advised to use individual safety protection whenever the environmental situations in which the appliance is used require it.
- When handling the sensors or test probes, do not place your fingers further than the physical guard.
- The instrument must not be used other than to adjust the sensors, if the battery housing cover is absent, damaged or incorrectly positioned.

definition of installation categories

Overvoltage category II is for equipment intended to be supplied from the building wiring. It applies both to plug-connected equipment and to permanently connected equipment. *E.g.: Measurements on the network circuits of household appliances, portable tools and other similar appliances.*

Overvoltage category III is for equipment intended to form part of a building wiring installation. Such equipment includes socket outlets, fuse panels, and some mains installation control equipment. *E.g. Measurements on distribution panels (including secondary meters), circuit breakers, cabling including cables, busbars, junction boxes, disconnecting switches, power outlets in the fixed installation, and industrial appliances and other equipment, such as motors permanently connected to the fixed installation*

Overvoltage category IV is for equipment installed at or near the origin of the electrical supply to a building, between the building entrance and the main distribution board. Such equipment may include electricity tariff meters and primary overcurrent protection devices. *E.g.: Measurements on systems installed before the main fuse or the circuit breaker of the building's installation.*

Symbols used



Risk of electric shocks: input connection and disconnection instructions. Always connect the sensors or adapters to the instrument before connecting them to the measuring points. Always disconnect the sensors or cables from the measurement points before disconnecting them from the instrument. These instructions apply before cleaning the instrument and before opening the battery housing cover and the sensor calibration outputs.

Warning: Risk of danger. The operator undertakes to consult the instructions each time this danger symbol is encountered.



Double insulation



Earth



In the European Union, this product is the subject of selective waste sorting for the recycling of electric and electronic equipment in compliance with the Directive WEEE 2002/96/CE: this equipment must not be considered as household waste. The spent batteries and accumulators must not be treated as household waste. Return them to the appropriate collection point for recycling.



This CE marking indicates compliance with the European "Low Voltage" and "Electromagnetic compatibility" directives (73/23/EEC and 89/336/EEC).



This product or this packaging is recyclable.

General (cont'd)

Warranty

This equipment has a 3-year warranty for faulty manufacture or materials as per our sales terms and conditions.

During this period the appliance may only be repaired by the manufacturer. The manufacturer reserves the right to proceed either with the repair, or with the exchange of all or part of the appliance. In the event of a return to the manufacturer, the shipping cost is paid by the customer.



The **warranty** will not apply in the event of:

- improper use of the equipment or use of the equipment with incompatible equipment
- a modification to the equipment without an explicit authorisation from the manufacturer's technical services
- intervention on the equipment by a person not approved by the manufacturer
- adaptation to a specific application that was not part of the definition of the equipment or the instructions for use
- shocks, falls or flooding.

Maintenance and metrology checks

As for all measurement or test instruments, regular checking is necessary. We recommend annual check of this instruments.

For checks, calibration, please return the device to your reseller.

Unpacking re-packing

The equipment has been checked mechanically and electrically before being shipped.



On receipt, make a rapid check in order to detect any damage during transport. If there is damage, please contact our sales department as soon as possible and transmit the legal reservations to the transporter.

In the case of re-shipping, preferably use the original packaging.

Repairs under warranty and outside the warranty

For repairs outside continental France, both with and without warranty, return the appliance to your local Chauvin Arnoux branch or to your reseller.

Cleaning



- Disconnect the sensors or measurement cables.
- Power off the appliance.
- Clean with a damp cloth and soap.
- Never use abrasive products or solvents.
- Let the appliance dry before further use.

Update of the instrument's firmware



- Log on to the site <http://www.chauvin-arnoux.com>
- In the "Support" section, select "Download Center".
- Download the "firmware" corresponding to the model you have purchased.
- Also download the firmware installation instructions.
- Consult this installation note to update your instrument.

Integrated Help function



The oscilloscope has an integrated help function, designed to provide help on the use of all the tabs on the main and secondary menus.



To consult the help function, press this key. Press it again to exit the help menu.



To view the integrated help in other languages, open the Tools menu and select the desired language.

Description of the instrument

Presentation

The particularity of these oscilloscopes is that they group **3 instruments** in one:

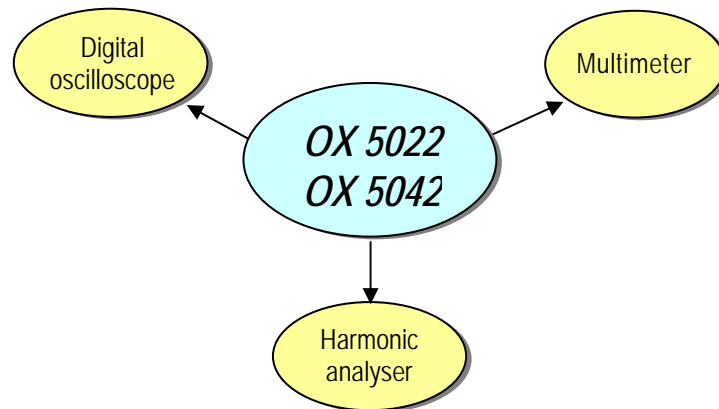

- a laboratory **digital oscilloscope** for the analysis of electronic and electrotechnical signals,
- a 2-channel, 8000-count **multimeter**,
- a **harmonic analyser**, for the simultaneous decomposition of 2 signals with their fundamental and their first 31 harmonics.

The instrument operates at a constant acquisition depth of 2,500 points.

An LCD TFT screen is used to view the applied signals along with all the setting parameters.

The main command functions are accessible using the keys on the front panel.

A graphic interface is used to:

- adjust the parameters related to the selected button,
- navigate using a horizontal main menu showing the current settings and vertical sub-menus.

Power supply

The oscilloscope is delivered with:

- one external power supply → Voltage: 12 VDC
Power: 1.25 A

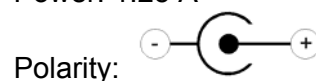

- 6 rechargeable → Ni-MH (1.2 V, 2700 mAh) accumulator batteries.

When the external power supply is connected, this power source is preferred for the instrument's operation. Thus the accumulators are only used when there is no external power supply.



With the external power supply you can use your oscilloscope even if the batteries are flat, defective or even absent.

Description of the instrument (cont'd)

Batteries



A "battery empty" indicator appears on the screen when the accumulator-battery charge level is insufficient and a new power source is needed quickly:

- connect the external power supply or
- change the batteries.

If the external power supplied is not connected when the level becomes critical, an alarm message "**Battery level is critical, the appliance is about to power off**" precedes the automatic shutdown of the instrument.

Charge

The batteries are charged when the oscilloscope is powered off but connected to the external power supply. During the fast charge of the batteries, the front-panel LED is on.

It flashes in the following situations:

- pre-charge of very flat batteries
- temperature too low or too high
- batteries damaged.

When the charge is complete the LED switches off. The batteries must be replaced with Ni-MH rechargeable batteries. Battery charge life is guaranteed for same-capacity batteries (in mAh) as those shipped with the oscilloscope.



It is possible, but not recommended, to use standard alkaline batteries (AA type) to replace the accumulators, but in this case be careful:

- ***not to connect the external power supply because when the instrument is switched off the charge mechanism is activated which can lead to destruction of the batteries and damage to the instrument;***
- ***not to leave the batteries in the instrument for too long to avoid any problems caused by leakage from the batteries.***

Access

If necessary, the batteries(1) are accessible from the rear panel of the oscilloscope after turning the "quarter turn" (2) lock anti-clockwise; use a coin (3):

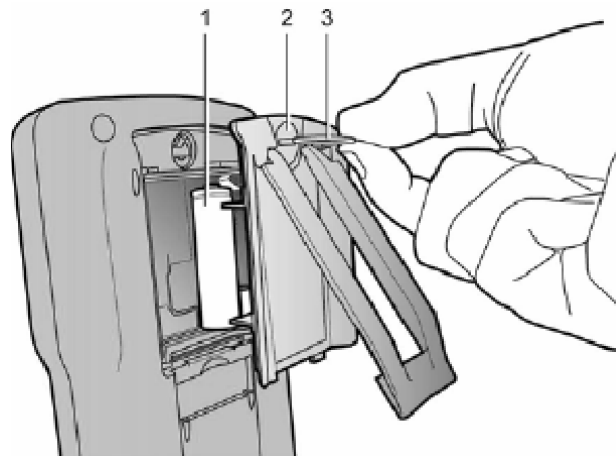

Description of the instrument (cont'd)

Channel insulation



The two oscilloscope input channels are insulated from each other and from the earth and the mains power supply block. This insulation is double or reinforced in compliance with the safety standards IEC 61010-1 and IEC 61010-2-030.

This makes it possible to make measurements on installations or systems connected to the electricity supply network for voltages of up to 600 V in CAT III. The common mode authorised between the two channels is 600 V in CAT III.

Thus the operator, the test systems and the environment are completely protected at all times.

Any voltage (even dangerous) on one channel will not be present on the other channel. The low points of the inputs are completely insulated, so there is no possibility of the low points looping (which can be dangerous and highly destructive).

The oscilloscope insulation is as shown in the diagram below:

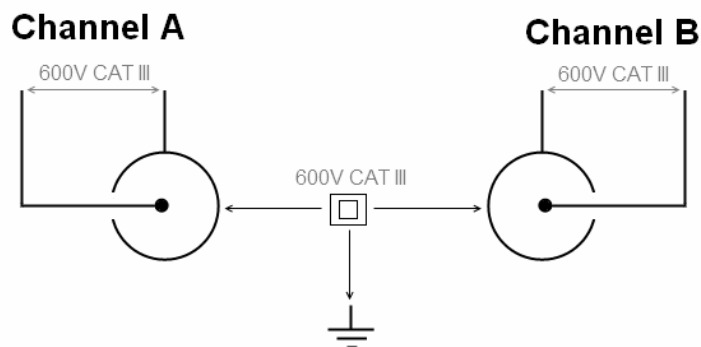

The use of accessories with a voltage and/or category lower than 600 V CAT III reduces the operating range to the lower voltages and/or categories.

Your oscilloscope is rated 600 V CAT III; at least 600 V CAT III accessories must be used. The accessories shipped with the instrument allow this.

Description of the instrument (cont'd)

OX 5022 & OX 5042

Front panel



Back face



Description of the instrument (cont'd)

Measurement terminals

Marking

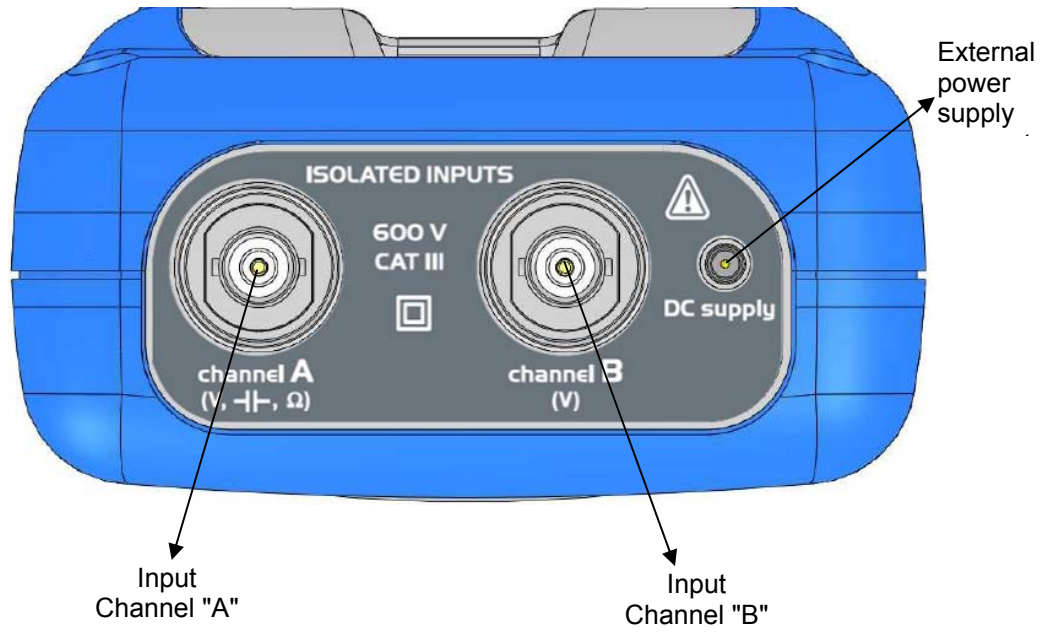

Side

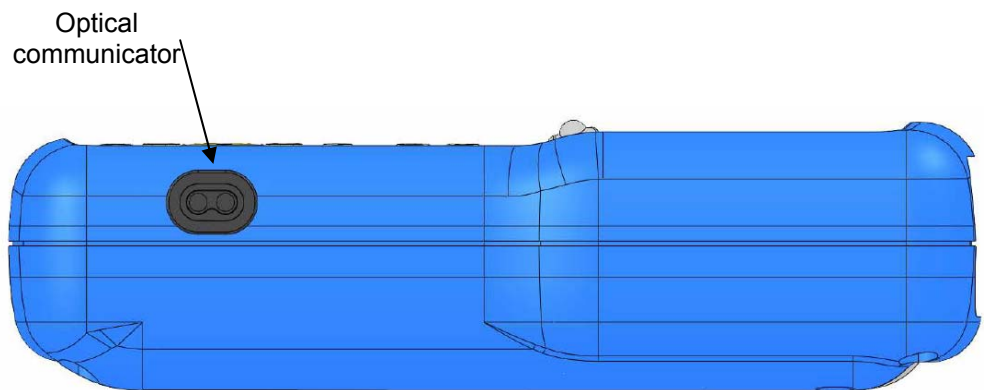

Description of the instrument (cont'd)

Advice for use of the sensors

Connection of the reference conductors to the sensor

Distribution of stray capacitors:

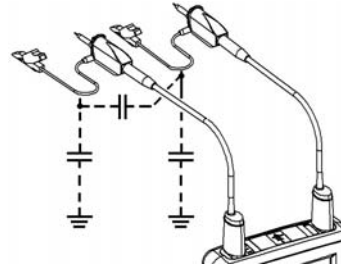

It is imperative, considering the stray capacitances, to correctly connect the reference conductors for each sensor. The conductors should preferably be connected to the cold points to avoid the transmission of noise by the stray capacitance between modes.

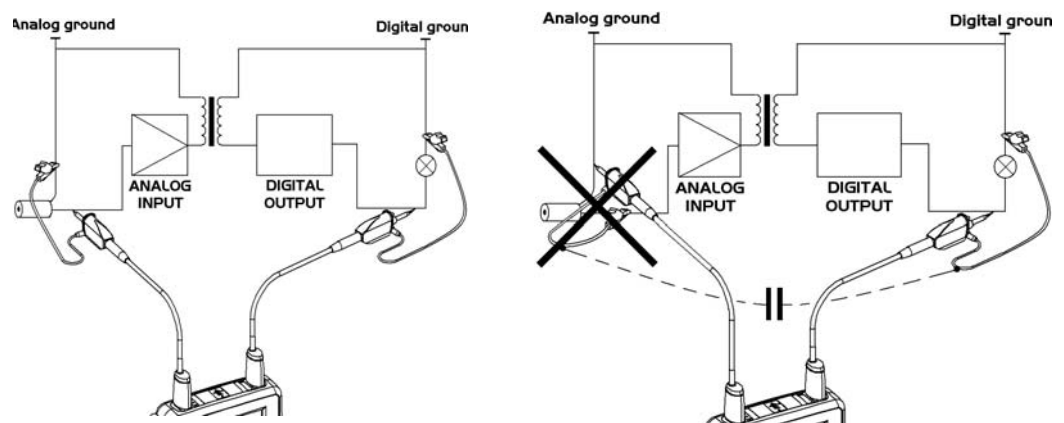

The noise of the digital ground (earth) is sent to the analogue input by the stray capacitance



Reminder In order to prevent electric shocks or possible fires:

Never use accessories on which the casing is accessible if it has a voltage of > 30 Vrms compared to the earth.

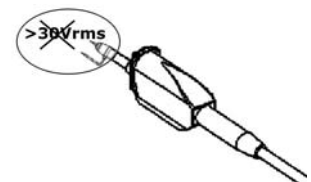

This precaution is necessary for example for sensors with an accessible metal BNC. The accessories shipped with the instrument are compliant.



Reminder See p. 4 Input connection and disconnection instructions.

Description of the instrument (cont'd)

Sensor calibration

The calibration output (3 Vpp, 1 kHz) for the sensors is underneath the battery cover (see p. 10).

To obtain optimum response, the sensor's low frequency compensation must be adjusted. To carry out this adjustment, the two channels of your oscilloscope must be disconnected from the measured circuits before opening the battery housing cover.



Connect the sensor to be adjusted to the calibration output under the battery housing cover, as shown opposite.



Select the DC coupling for the channel to which the sensor is connected and run an autoset (icon opposite) to carry out pre-setting. Adjust the sensitivity and the vertical offset of the channel so that the signal fills the screen, and adjust the time base to 200 μ s to view a signal period on the screen. Turn the BNC base of the sensor in order to access the sensor adjustment screw:

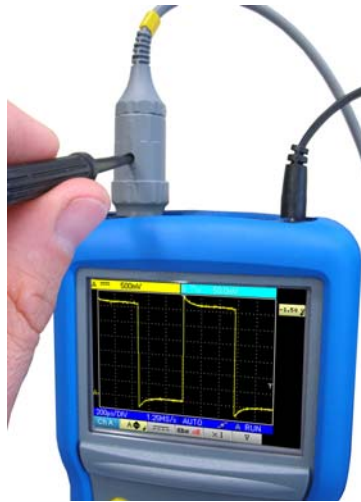

In the example opposite the sensor is over-compensated: an overshoot occurs.

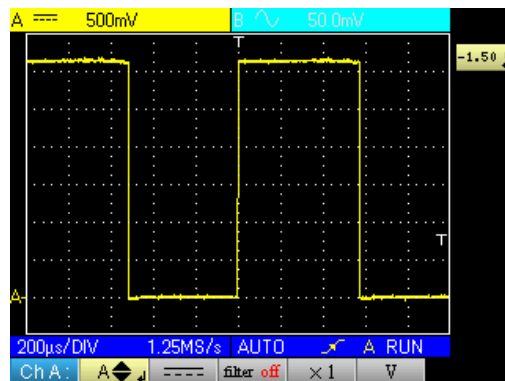

Turn the screw in either direction until the signal is horizontal and looks like the screen shown opposite. Your sensor is now calibrated, so you can turn the BNC base again to close access to the adjustment screw.

 **Replace the battery cover in order to use your instrument in optimum safety conditions.**

Description of the instrument (cont'd)

Front panel (description)

The main functions of the instrument are accessed from the front panel.

1 on / off key



The instrument is switched on by a short press on the key shown opposite. It is switched off by a long press (a shutdown message appears and a beep sounds).

3 "operating mode" keys



Pressing on one of these three keys selects the instrument's operating mode:

- "oscilloscope ", see p. 15.
- "multimeter" see p. 48.
- "harmonic analyser" see p. 57.

5 navigation keys

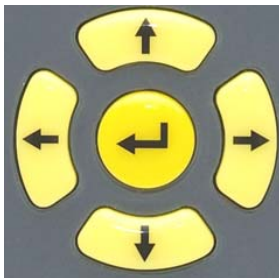

This block of keys is used to move around the menus and in the dialogue boxes; it is also used to move graphic objects (cursor, trigger, memory position...) through the menus.

- Action of the horizontal keys:
 - Horizontal movement through the main menus
 - Adjustment of values in the secondary menus
 - Horizontal movement in a dialogue box
- Action of the vertical keys:
 - Vertical movement and automatic selection in the secondary menus
 - Adjustment of values in the main menus
 - Vertical movement in a dialogue box
- Action of the central "Enter" key:
 - Opens a dialogue window from a main menu or a secondary menu
 - Validation of the items in a dialogue window

Oscilloscope Mode

The keys



Pressing this key selects the "Oscilloscope" mode.

6 "Menu" keys



displays the main "Trigger" menu, see p. 31.



displays the main "Acquisition" menu, see p. 36.



displays the main "Tools" menu, see p. 46.



displays the main "Measurement/Cursor" menu, see p. 40.



displays the main "Memory" menu, see p. 43.



displays the "Help" window, see p. 47.

3 Channel A, B, and Math or Memory keys



- A simple press **selects** channel A (or B) and shows the corresponding menu.

- Pressing twice **deselects** the channel.

- A single press **selects** channel M (Math) and shows the corresponding menu.

- Pressing twice **deselects** the channel.



For the M (memory) channel, pressing twice invalidates the channel. Pressing once again selects the Math channel, the memory is lost and must be reloaded.

2 "Time base" keys



increases the time base for acquisition up to 200 s.



decreases the time base for acquisition down to 25 ns.

2 "sensitivity" keys



decreases the vertical sensitivity of the last selected channel down to 5 mV.



increases the vertical sensitivity of the last selected channel up to 200 V.



For the M channel, the "sensitivity" key varies the amplitude factor but only if a math channel is validated.

2 functional keys



performs an automatic adjustment on channels A and B. The success of each vertical autoset conditions the activation of the channel.



starts or **stops** an acquisition.

Oscilloscope Mode Display

Display

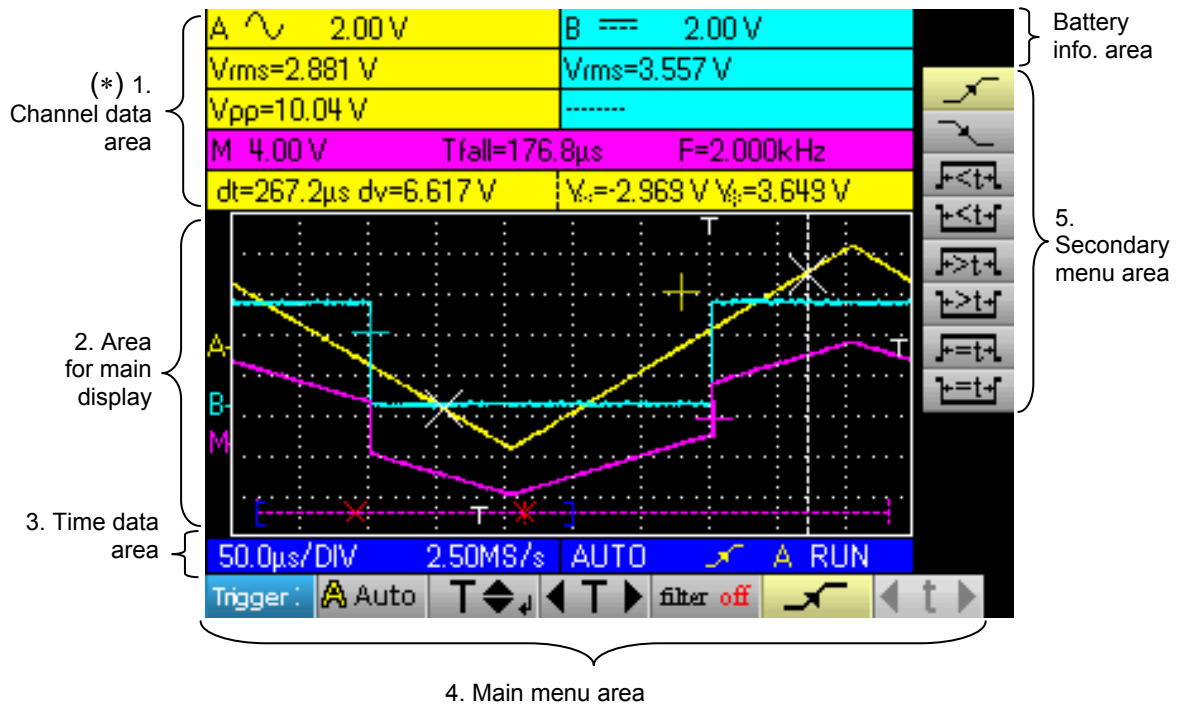

1. Channel data

A 2.00 V	B 2.00 V
Vrms=2.881 V	Vrms=3.557 V
Vpp=10.04 V	----- (*)
M 4.00 V	Tfall=176.8µs F=2.000kHz
dt=267.2µs dv=6.617 V	V ₁ =-2.969 V V ₂ =3.649 V

a) "Main channel" area

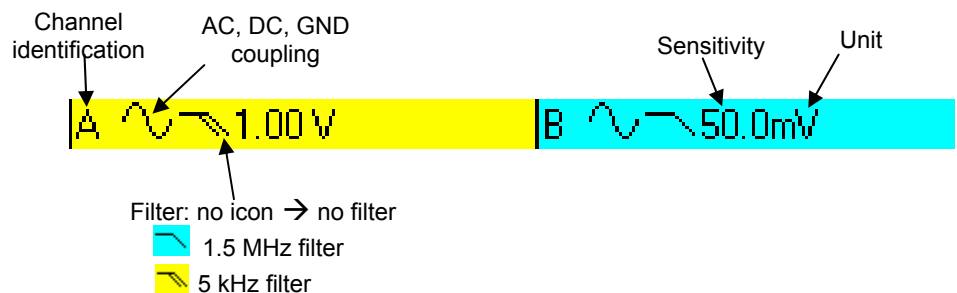

The direct data from channels A and B are displayed in this window:

- Channel identification
- Channel coupling
- Filter
- Channel sensitivity
- Channel unit

(*) **If no measurement is selected, if measurement is impossible or if the channel is not validated, the measurement will be replaced by dashes.**

Oscilloscope Mode Display (cont'd)

b) "Automatic measurement" area

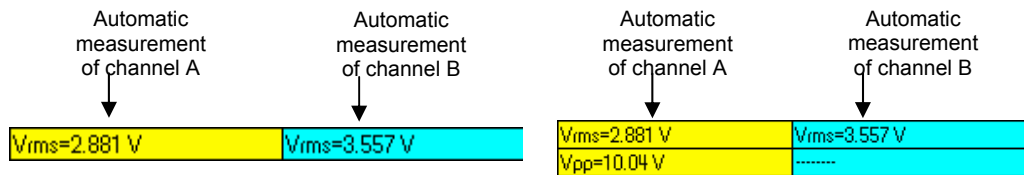

The selected automatic measurements are shown in this window. 1 or 2 measurements per channel can be selected.

c) "Math" area

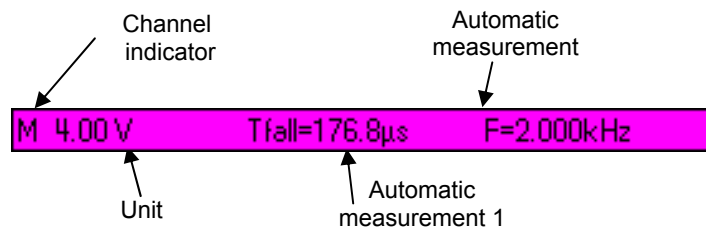

Violet background in "M" channel shows a Math function

or "Memory" area

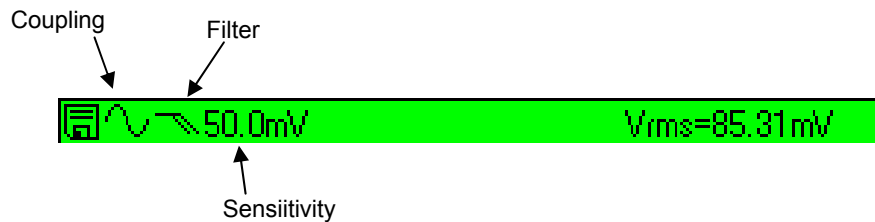

Green background if "M" channel shows a Memory function

The "M" channel data is shown in this window. This channel can contain a "Math" or a "Memory" function.

If the "M" channel shows a "Math" function, the following data is shown:

- Channel identification
- Sensitivity
- Unit
- Automatic measurements

If the "M" channel shows a "Memory" function, the following data is shown:

- Channel identification
- Sensitivity
- Coupling
- Filter
- Unit
- Automatic measurements

Oscilloscope Mode Display (cont'd)

d) "Cursor measurement" zone

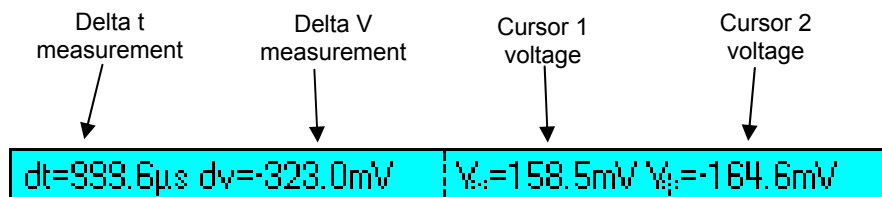

The measurements by cursor are shown in this window. The background colour is identical to that for the channel to which the cursors are attached. It indicates:

- the horizontal difference (dt) and vertical difference (dv) between the 2 cursors,
- the voltage measurement of the cursors.

2. Main display

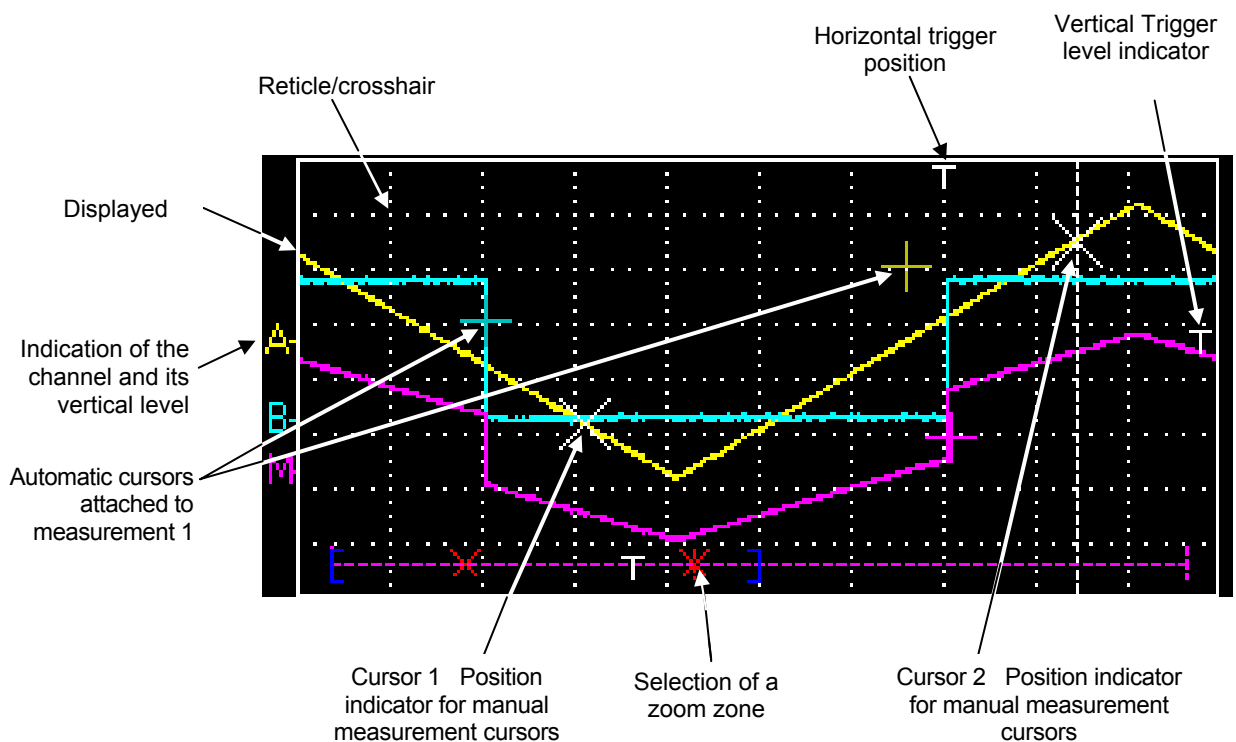

Oscilloscope Mode Display (cont'd)

3. Time data

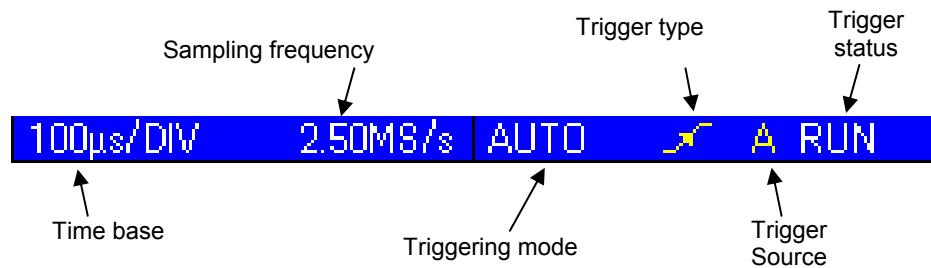

This window is split into two groups:

- a time data group
 - time base
 - sampling frequency
- a trigger data group
 - triggering mode
 - trigger type
 - trigger source
 - trigger status: RUN, READY, STOP.

4. Main menu area



Main menu: displays the oscilloscope configuration

5. Secondary menu area

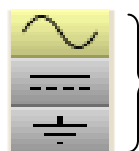

Secondary menu: gives access to various parameter settings selected from the main menu.

Oscilloscope Mode The Menus

Display

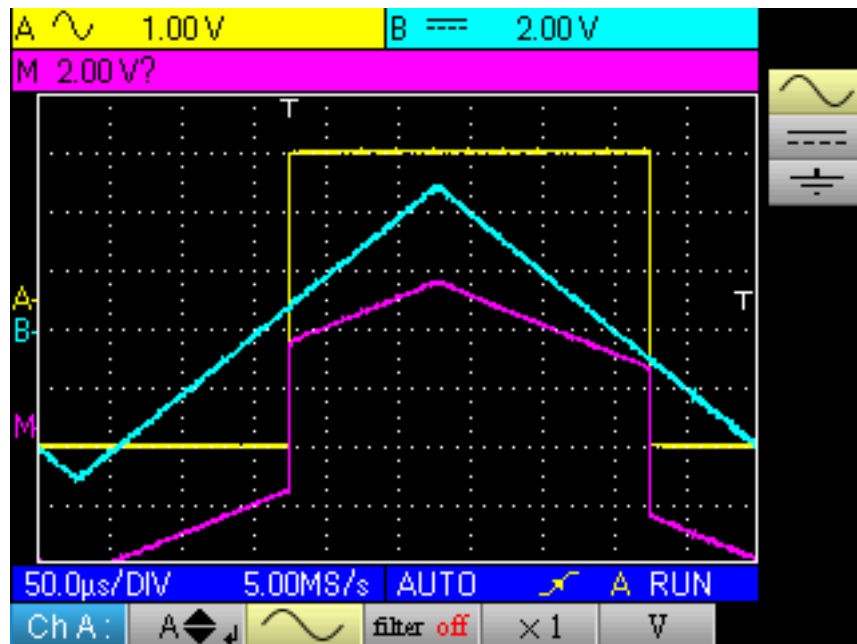

Organization

The menus have two elements:

- a horizontal menu, called "main", located at the bottom of the screen;
- a vertical menu, called "secondary" located to the right of the screen

Main menu



When a tab is selected in the menu, its background turns yellow. When a setting is not available in the current mode, it is greyed out in the main menu and cannot be selected.

Secondary menu



Each tab of the main menu is associated with a secondary menu used to view the different possible settings for the parameter in question.

Navigation

Classical navigation

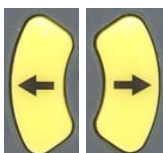

These keys are used to navigate in the main menu.



These keys are used to:



- navigate in the secondary menu,
- set a vertical parameter (see §. Vertical settings)



Oscilloscope Mode The Menu (cont'd)

Vertical settings





Vertical settings are recognised by the double arrows  on the main menu tab.

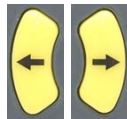

- To change the value:
 - the   keys are used to change the numeric value displayed in the secondary menu and therefore move the graphic object linked to the settings in the direction of the arrows
 - the  key opens the data entry window for direct value entry (see §. Activating a dialogue window).

- To quit the setting:







The   keys can always be used to navigate the main menu and therefore quit the setting.

Horizontal settings

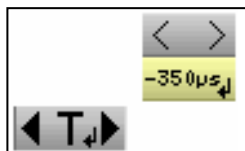



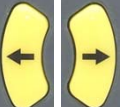

The horizontal settings are recognized by the two arrows that  frame the parameter identification on the main menu tab.



- To change the value: using the   keys, select the numeric value tab from the secondary menu.
 - the   arrows are used to change the value and therefore move the linked graphic object in the direction of the arrows;
 - the  key is used to open the direct value entry window (see §. Activating a dialogue window).

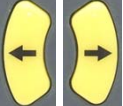

- To quit the setting:
 - using the   keys, select the quit tab  from the secondary menu;
 - the   arrows can then be used to navigate the main menu.

Oscilloscope mode

The Menus (cont'd)

Activating a dialogue window

The settings that can be adjusted using a dialogue window can be recognized from the  symbol on the menu tab.

When the tab is selected, pressing the  key opens a dialogue window.

Direct settings entry window

This window is used to directly adjust the numeric value of the parameter in question.

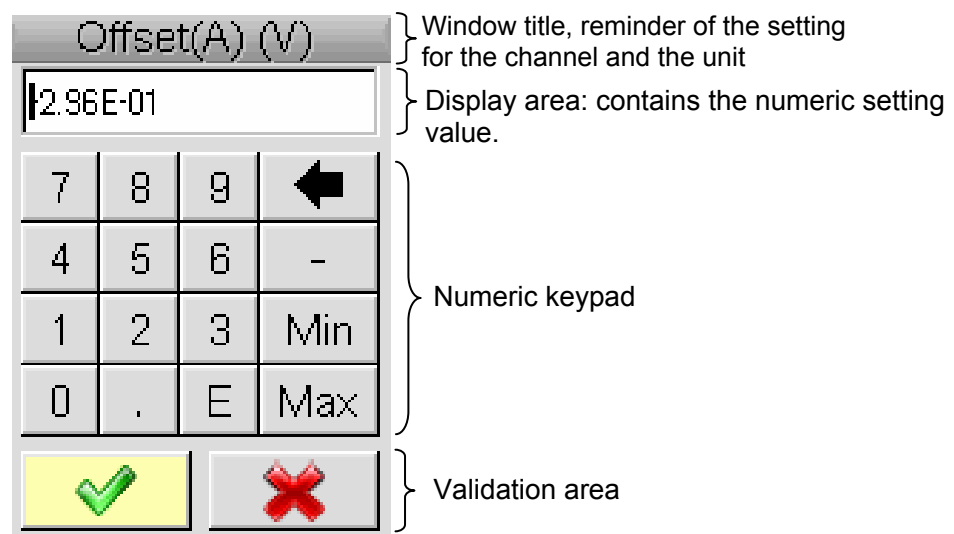

Navigation in the active element window (yellow highlighting)



Validation of the activated key or, in the display area, "Input / Output" for the selection mode.



The selection mode is used to select several characters from the display area (blue highlighting) using the keys :

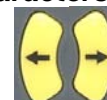

The selected characters can be replaced in this way by the value of the button which is validated on the numeric keypad

(or deleted using the  button).

When the window opens, the current variable value is completely selected by default.

Oscilloscope Mode The Channel "A" or "B" menu

The Channel "A" or "B" menu

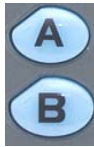

Press one of these two keys.

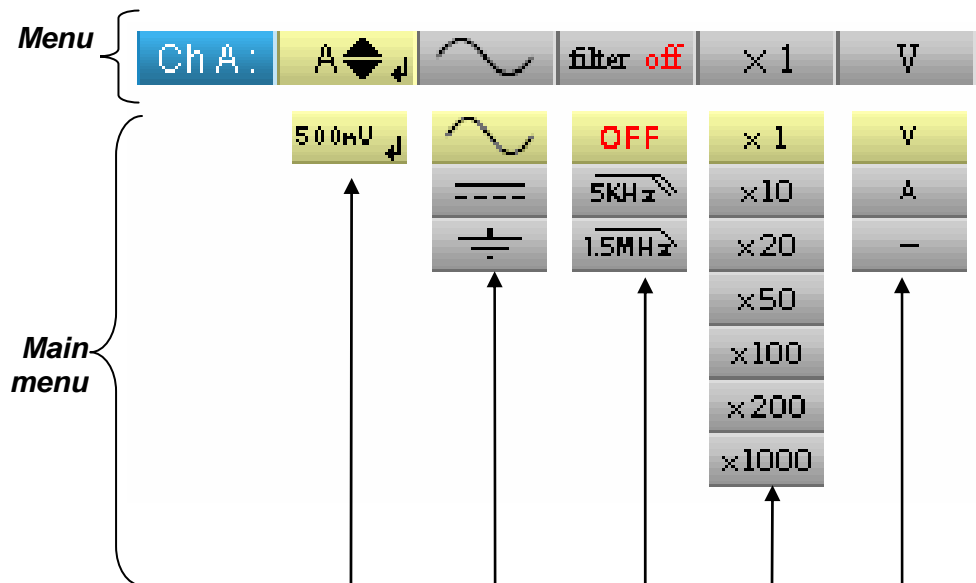

- (*) • sets and displays the numeric value of the vertical offset
- selects the channel coupling (AC, DC, GND)
See example 1. p. 24.
- selects the channel filter (OFF, 5 kHz, 1.5 MHz)
See example 2. p. 25.
- selects the sensor factor for the channel (from x1 to x1000)
See example 3. p. 26.
- selects the channel unit (volts, amps, -)
(-) means: no unit.

Oscilloscope Mode

The Channel "A" or "B" menu (cont'd)

Examples

- 1. Channel coupling** Injection of a 1kHz, 2Vpp amplitude sinusoidal signal with an offset of 0.5 V:
- with AC coupling (the DC component is removed):

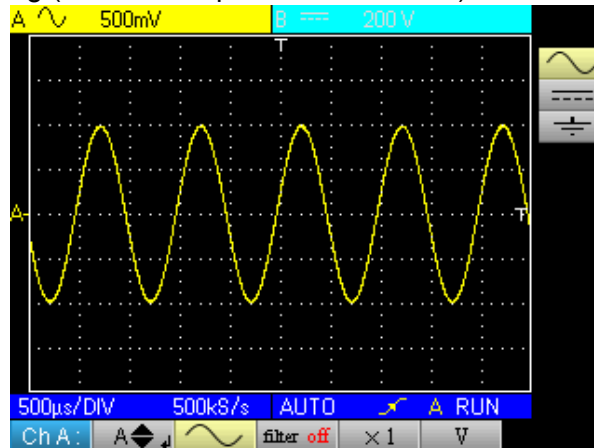

- with DC coupling (the entire signal is measured):

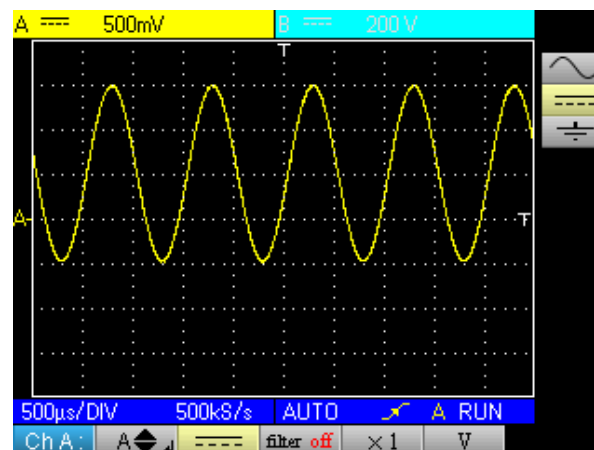

- using GND coupling (no signals are measured):

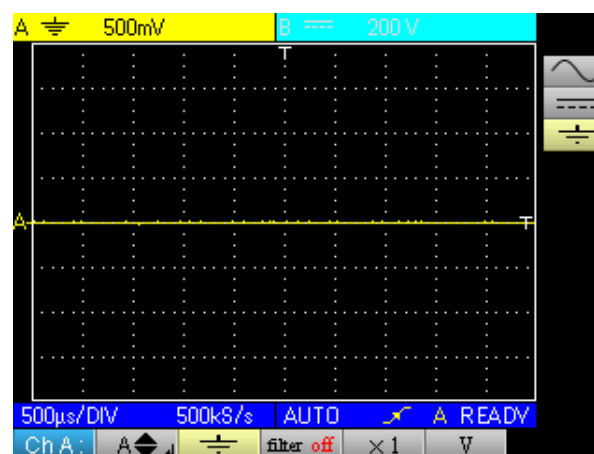

Oscilloscope Mode The Channel "A" or "B" menu (cont'd)

2. Channel filter Superimposition of 2 sinusoidal signals with a frequency of 100 Hz and 3 MHz, respectively:

- without filter (both signals are sent):

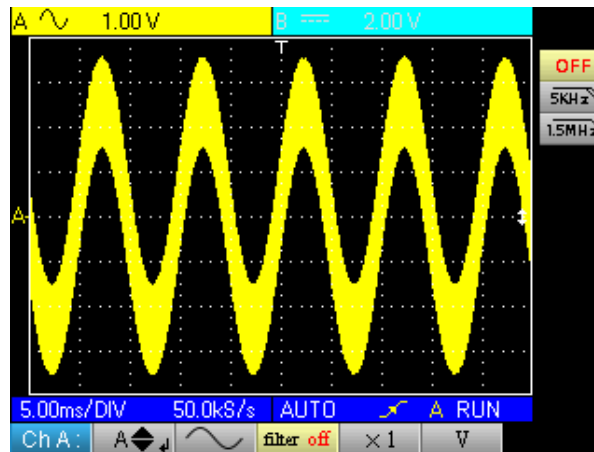

- with the 5 kHz low-pass filter (the 3 MHz sinusoidal is cut):

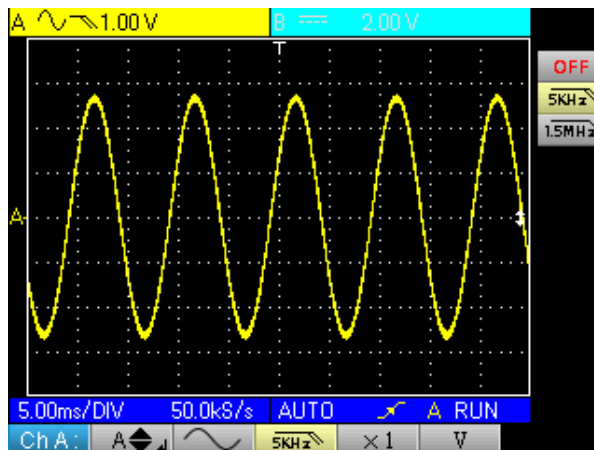

- with the 1.5 MHz low-pass filter (the sinusoidal is partially cut):

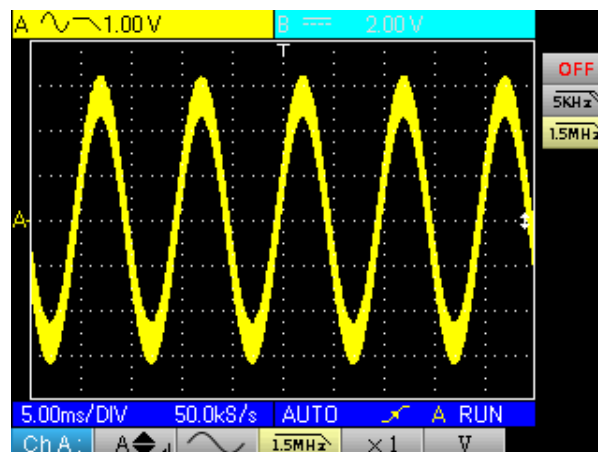

Oscilloscope Mode

The Channel "A" or "B" menu (cont'd)

3. Sensor factor Observation of a sinusoidal signal of 2 Vpp and 100 Hz with a x 10 sensor:

- with the factor x 1: the amplitudes and sensitivity are incorrect (factor 10)

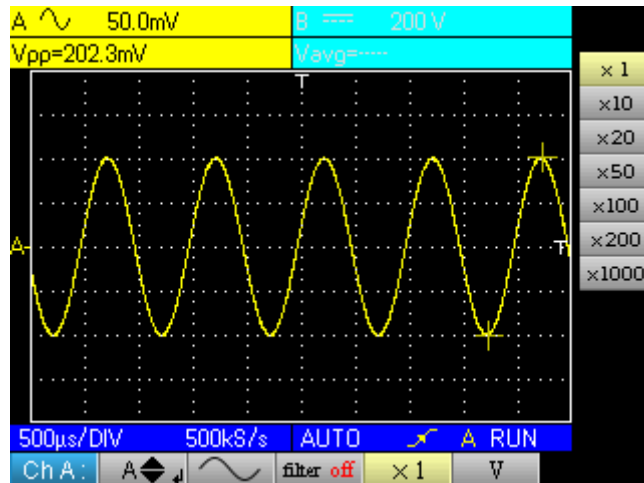

- with the factor x 10: the amplitudes and sensitivities are correct

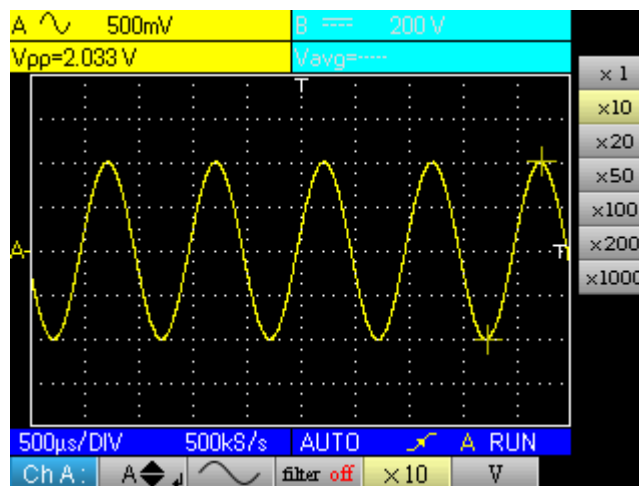

Oscilloscope Mode The "Math Channel" menu

The "M Channel" menu



Press this key.

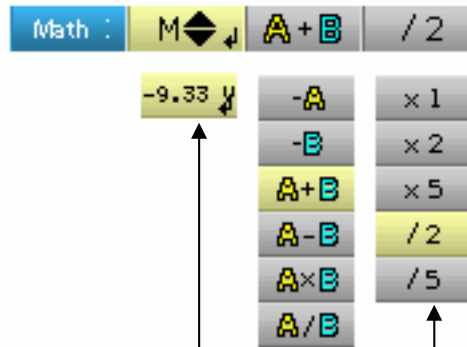

- adjustment of the vertical offset for the Math channel or the stored trace _____
- selects a mathematical function _____
- selects the factor for the "Math" function _____

Oscilloscope Mode

The "Math Channel" menu (cont'd)

Examples

1. *Mathematical functions*

Warning, the calculation of the mathematical functions is not carried out on physical quantities, but on the signal samples. Be careful in particular to use identical sensitivities on channels A and B for addition and subtraction so that the calculation is meaningful.

Thus, the sensitivity of the Math channel is determined as follows:

Operation	Sensitivity Channel A	Sensitivity Channel B	Sensitivity Channel M
- A	X	-	X
- B	-	Y	Y
A + B	X	Y = X Y ≠ X	X X ?
A - B	X	Y = X Y ≠ X	X X ?
A * B	X	Y	XY
A / B	X	Y	X / Y

Example 1 M = A + B, addition of a 5 Vpp sine with a 5 Vpp square almost in phase:

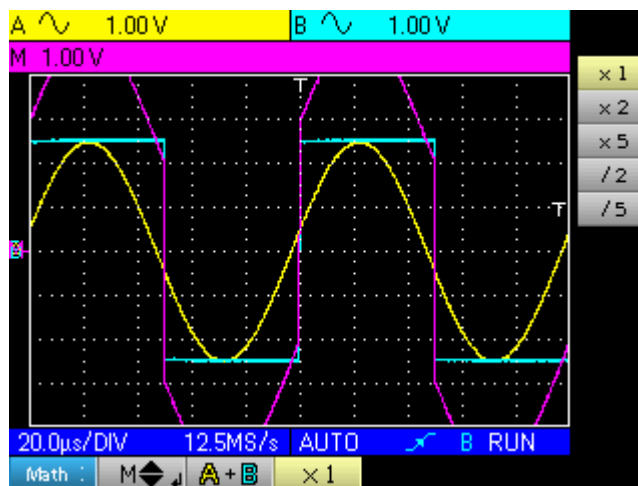

Oscilloscope Mode The "Math Channel" menu (cont'd)

In our example the amplitude of the resulting signal is 10 Vpp. As the sensitivity of channel M is 1 Vpp, it can be seen that the trace overshoots but is contained on the screen by dividing the representation by 2:

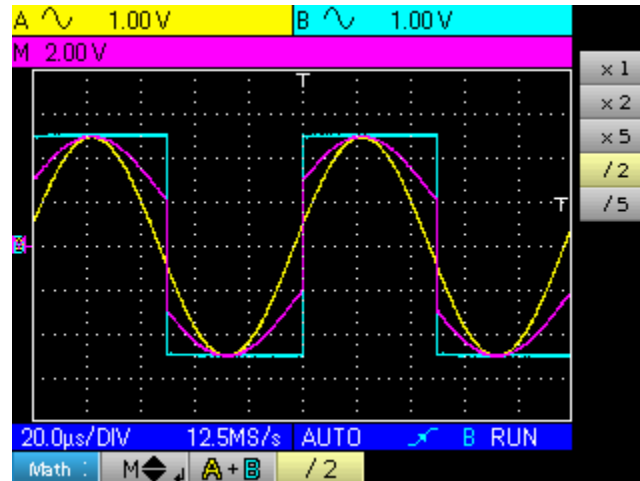

The sensitivity of the M channel becomes 2 V and the amplitude remains at 10 Vpp.

Example 2 $M = A * B$, multiplication of a 5 Vpp sine and square almost in phase:

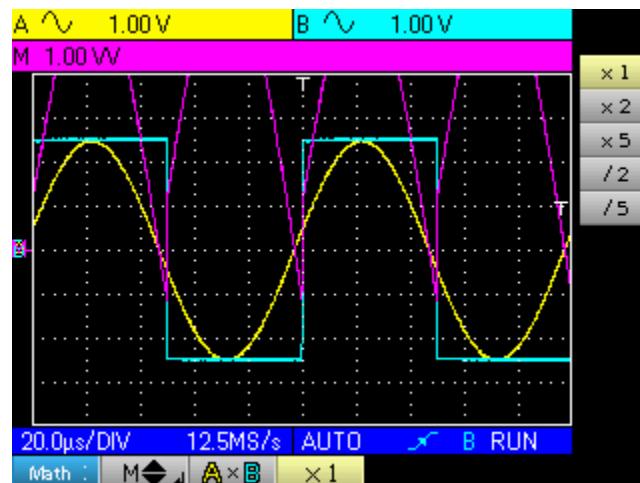

In our example, the peak amplitude of our mathematical function is $2.5 \text{ V} * 2.5 \text{ V} = 6.25 \text{ VV}$. As the channel M sensitivity is 1 VV (with the factor x 1), it can be seen that the trace overshoots and can be corrected by using the /2 coefficient.

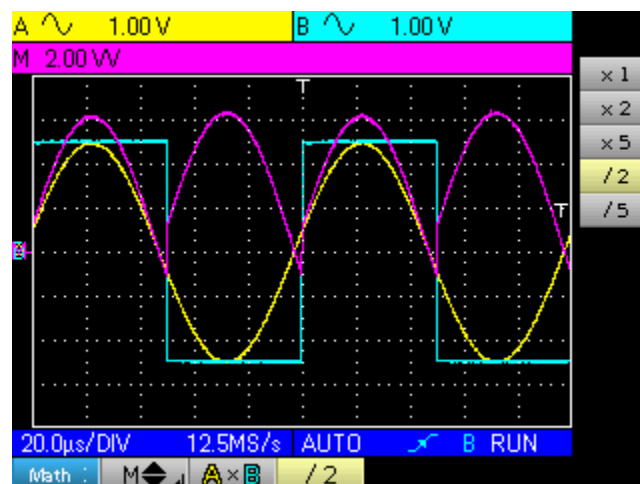

The sensitivity of channel M becomes 2 VV and the peak voltage is $3.125 * 2 \text{ VV} = 6.25 \text{ VV}$.

Oscilloscope Mode The "Math Channel" menu (cont'd)

Example 3

$M = A / B$, division of a 5 Vpp sine and square almost in phase:

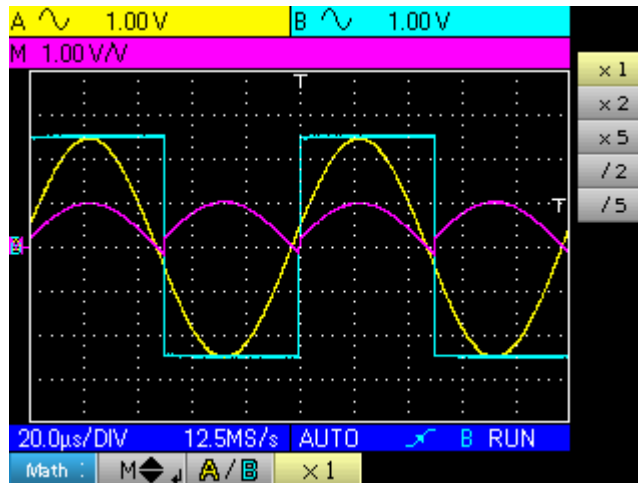

As the positive voltages of signals A and B are equal, the division leads to a positive peak voltage of 1 V/V, and therefore a representation of 1 division on the trace. This can be expanded by choosing factor x 2 or x 5:

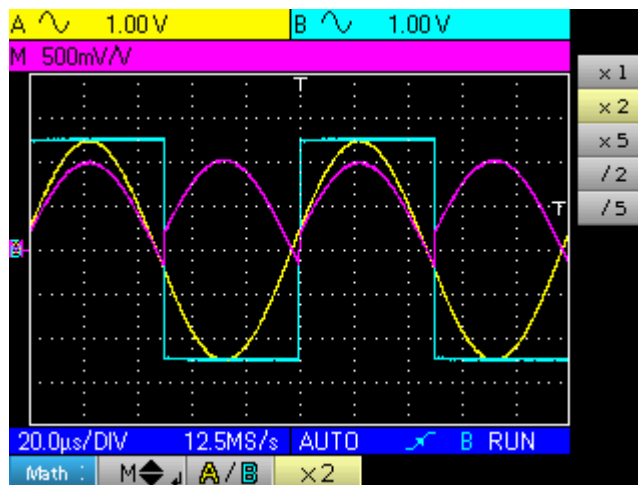

The sensitivity of channel M changes to 500 mV/V and the positive peak amplitude of the trace is 1 V/V.

Oscilloscope Mode

The "Trigger" menu

The "Trigger" menu



Press this key.

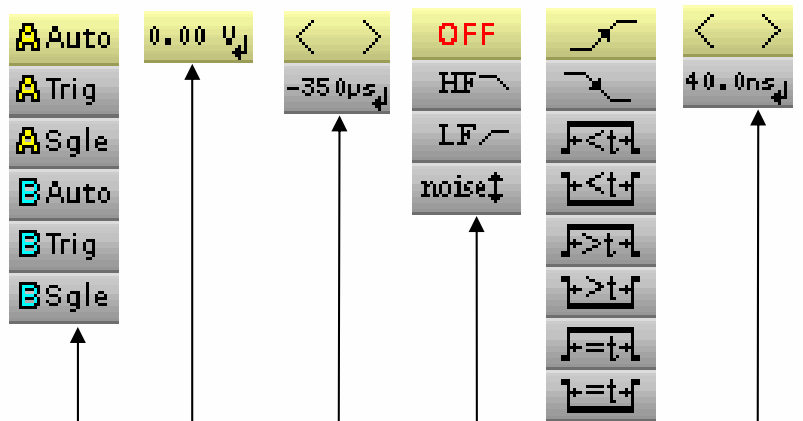

- selects the Trigger source and the trigger mode
- adjusts and displays the vertical trigger level
- sets and displays the event time position in relation to the trace area
- selects the Trigger filter (OFF, HF Reject, LF Reject, Noise, Hysteresis) See examples 1. p. 33 and 2. p. 35.
- selects the Trigger type (front or pulse width)
- sets and displays the numeric value for "t", a parameter of the Pulse Trigger, this setting is only possible for the Pulse Trigger

< > used to switch to the other menus







< > Exit tab

Oscilloscope Mode

The "Trigger" menu (cont'd)

Description

Trigger Source and trigger mode

Tab	Trigger Source	Triggering mode
 Auto	Channel A	automatic
 Sggle	Channel A	single shot
 Trig	Channel A	triggered
 Auto	Channel B	automatic
 Sggle	Channel B	single shot
 Trig	Channel B	triggered



- **"Single shot"** mode:

A single acquisition triggered by pressing the key opposite is authorised. For a new acquisition the triggering circuit must be rearmed by pressing on the key shown opposite.

- **"Triggered"** mode:

The content of the screen is only refreshed on a triggering event linked to the signals present on the oscilloscope inputs.

In the absence of a triggering event related to the input signals (or the absence of input signals), the trace is not refreshed.

- **"Automatic"** mode:

The content of the screen is refreshed, even if the trigger level is not detected on the signals on the inputs.

In the presence of a triggering event, the screen refresh is managed as in "triggered" mode.

Trigger Type

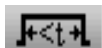

Rising edge trigger



Falling edge trigger



Pulse trigger less than "t", with positive pulse



Pulse trigger less than "t", with negative pulse



Pulse trigger greater than "t", with positive pulse



Pulse trigger greater than "t", with negative pulse



Pulse trigger equal to "t", with positive pulse



Pulse trigger equal to "t", with negative pulse

Oscilloscope Mode The "Trigger" menu (cont'd)

Examples

1. Trigger Filter Display of a 1 kHz sine with noise (Acquisition Envelope ON)

- without trigger filter (we trigger on the edge of the 1 kHz signal but, depending on the noise value, we trigger on the rising or falling edge):

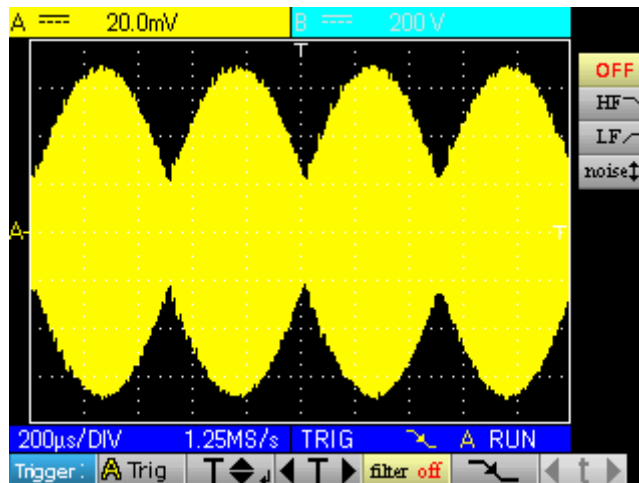

- with the HF reject filter (the noise is filtered, we trigger on the 1 kHz sine):

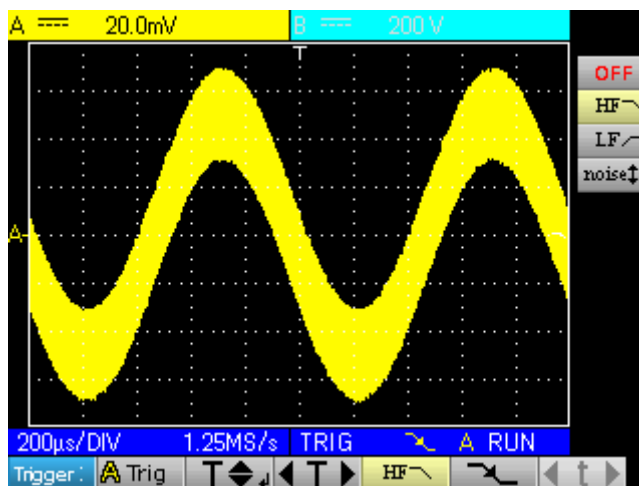

Oscilloscope Mode

The "Trigger" menu (cont'd)

- with the LF reject filter (the 1 kHz signal is filtered, we trigger on the noise → not effective in this case):

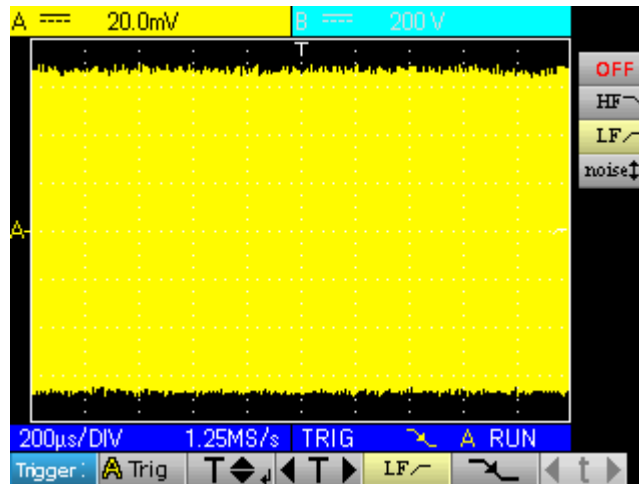

- with the Noise filter (the trigger hysteresis changes to 3 div., we trigger on the 1 kHz sine):

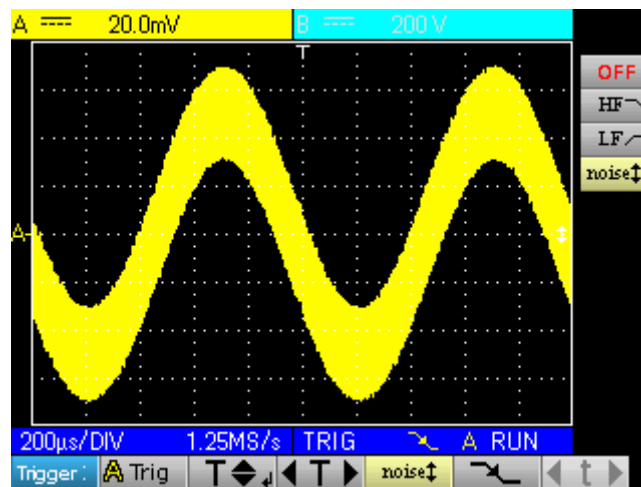

Oscilloscope Mode The "Trigger" menu (cont'd)

2. Other LF reject filter example

Observation of a slow 10 Hz sine on which peaks show every 200 ms (PkDet activated)

- Case of noise: (we only trigger on the sine edge as it is not easy to zoom on the peaks)

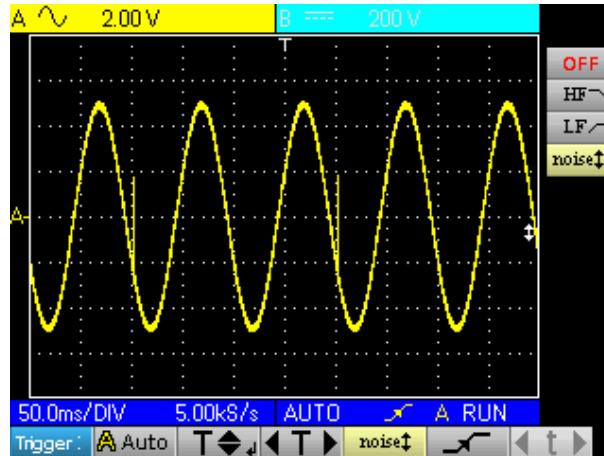

- LF reject case: (we remove the 10 Hz signal and can trigger on the peak and zoom)

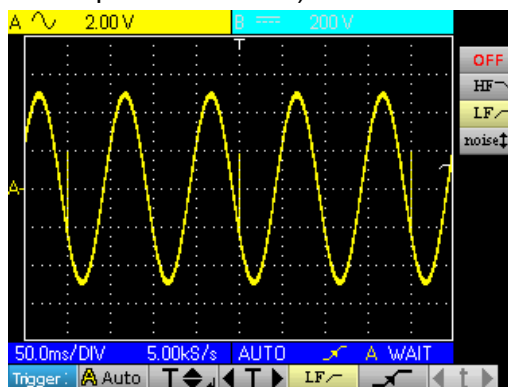

- By changing the time base, the peaks can be observed correctly:

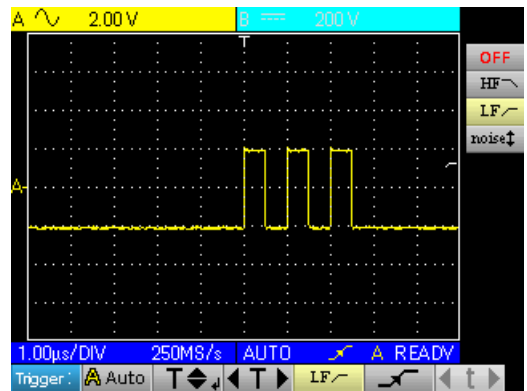

This can also be achieved without a filter, but by selecting triggering on a pulse width of less than 1µs:

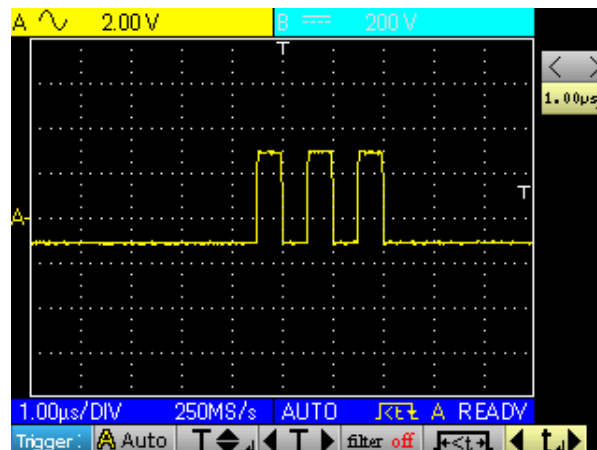

Oscilloscope Mode

The "Acquisition" menu

The "Acquisition" menu



Press this key.

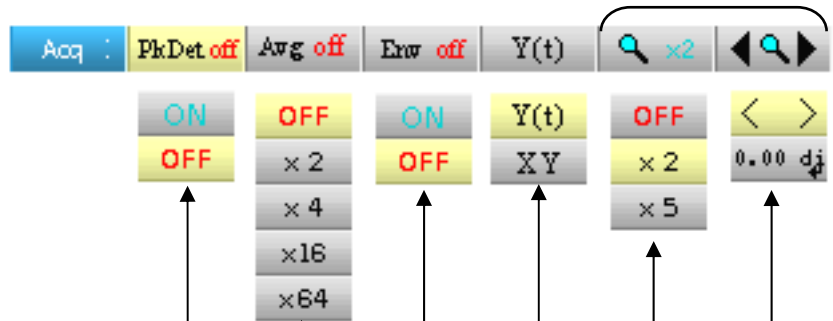

- activates or deactivates the "Peak detection" menu — See example 1, p. 37.
- selects or deactivates the averaging function factor — See example 2, p. 38.
- activates or deactivates the "Envelope" mode — See example 3, p. 39.
- selects the time or "XY" mode —
In the "XY" mode, "CHA" is used as the x-axis and "CHB" as the Y axis. The "M" channel cannot be represented using "XY" mode. The cursors cannot be activated in this mode.
- selects or deactivates the "Zoom" factor
- moves the time-based zoom window (this adjustment is only possible if a zoom is active)

< > Exit tab

Oscilloscope Mode The "Acquisition" menu (cont'd)

Examples

1. *PkDet* acquisition

Observation of rapid pulse combs with a low repetition frequency

- without PkDet (the repetition frequency of the combs gives an inappropriate sampling frequency for viewing the signal, so there are missing combs):

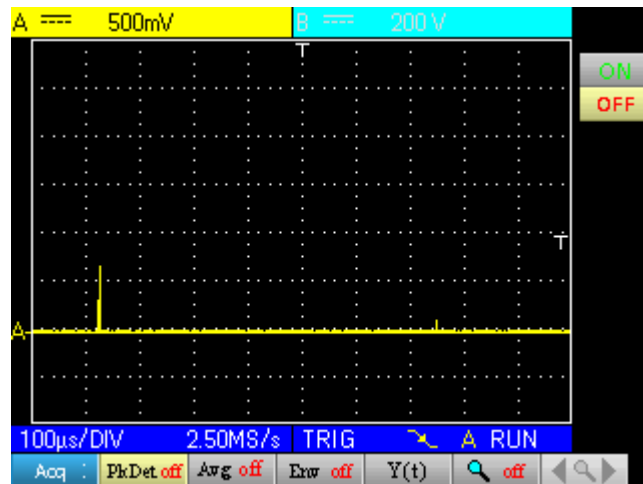

- with PkDet (the detection of the min and max obtained between two sampling steps makes it possible to view all the combs):

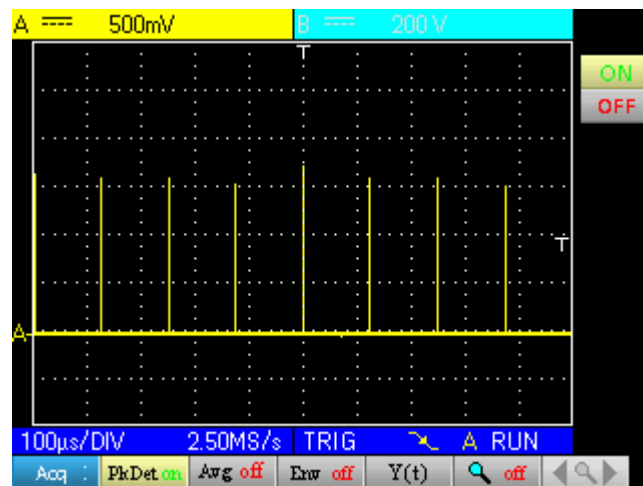

Oscilloscope Mode

The "Acquisition" menu (cont'd)

2. Acquisition averaging

Observation of a 1 kHz sine with noise. Prior to averaging make sure that the trace is stable. In our example the Noise filter from the Trigger menu is activated.

- without averaging:

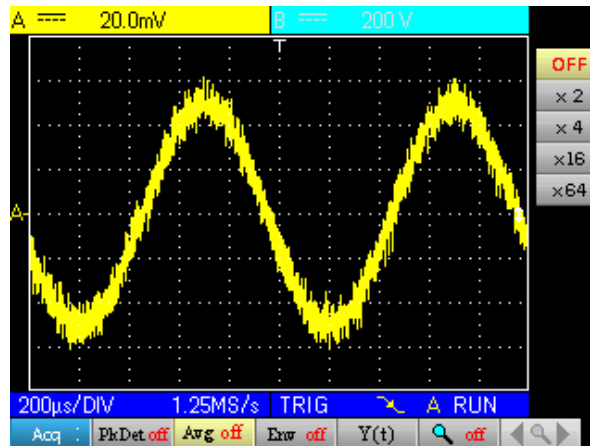

- with x 4 averaging (the noise is reduced):

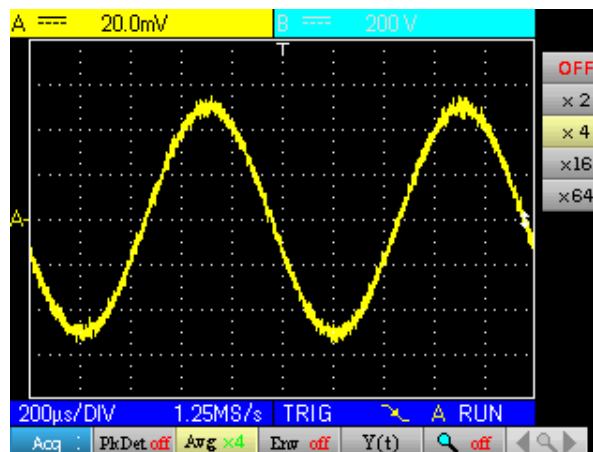

- with x 64 averaging (the noise has almost disappeared):

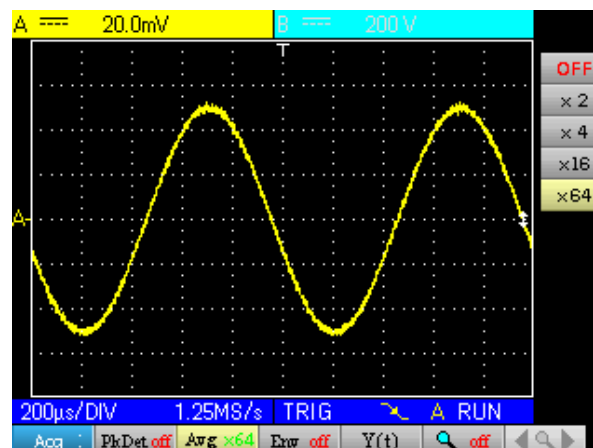

Oscilloscope Mode The "Acquisition" menu (cont'd)

3. Envelope acquisition

Observation of a sinusoidal signal with amplitude modulation

- without envelope (an acquisition is viewed at each triggering):

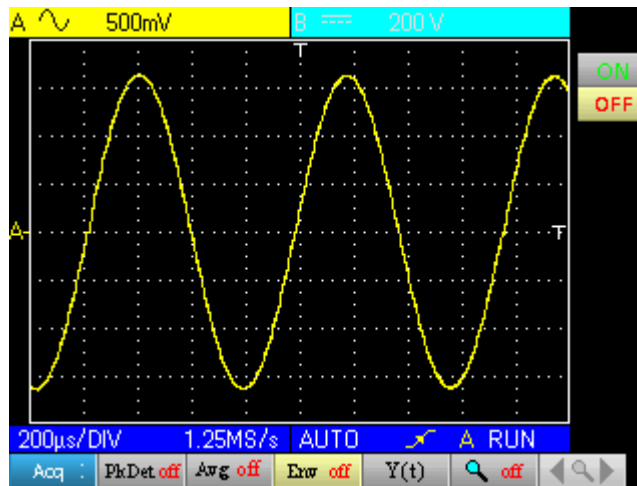

- with Env (the acquisitions are cumulated and an envelope is made using the min and max points for each x axis):

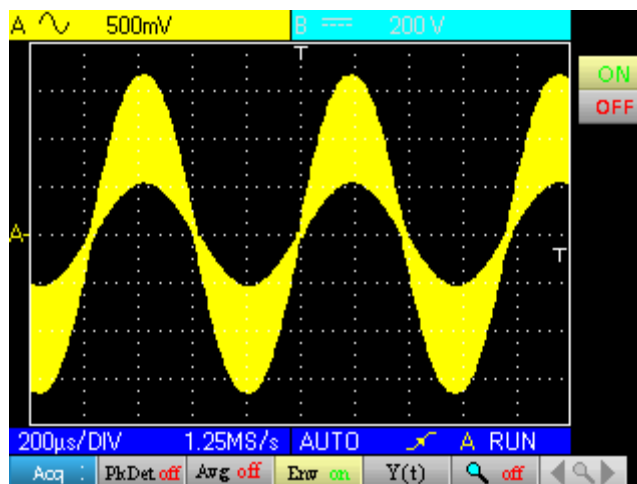

Oscilloscope Mode

The "Measurement" menu

The "Measurement" menu



Press this key.

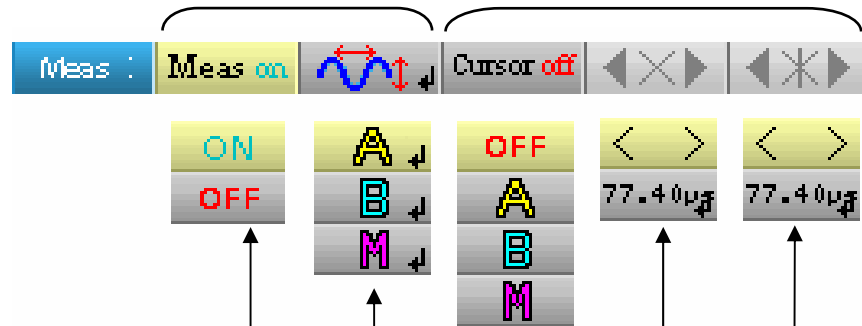

- activates or deactivates automatic measurement display
- used to open the configuration window for automatic measurements on the channel in question (by pressing the key opposite) (*)
- activates or deactivates cursor measurements
- sets and displays the numeric value of cursor 1 position(**)
- sets and displays the numeric value of cursor 2 position (**)



(*) This setting is only possible if the automatic measurement display is active.

(**) This setting is only possible if the cursors are active.

Oscilloscope Mode The "Measurement" menu (cont'd)

Description of the configuration window for automatic measurements

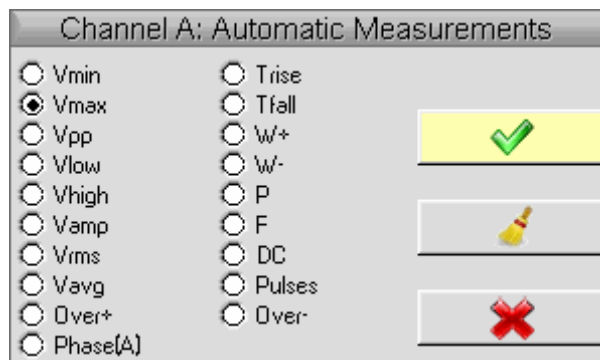

Movement of the selection in the window



Validation of the selection

Name	Measurement description	Automatic cursor indication
Vmin	minimum peak voltage	Vavg and Vmin
Vmax	maximum peak voltage	Vavg and Vmax
Vpp	peak-to-peak voltage	Vmin and Vmax
Vlow	established low voltage	Vavg and Vlow
Vhigh	established high voltage	Vavg and Vhigh
Vamp	amplitude	Vlow and Vhigh
Vrms	root-mean-square voltage	Vrms and measurement interval
Vavg	average voltage	Vavg and measurement interval
Over+	positive offset	Vmin and Vmax
Trise	rise time	points used for the calculation
Tfall	fall time	points used for the calculation
W+	width of positive pulse (at 50% Vamp)	Vavg and points used for the calculation
W-	width of negative pulse (at 50% Vamp)	Vavg and points used for the calculation
P	period	Vavg and points used for the calculation
F	frequency	Vavg and points used for the calculation
DC	duty cycle	Vavg and points used for the calculation
Pulses	number of pulses	Vavg and points used for the calculation
Over-	negative overshoot	Vmin and Vmax
Phase (A)	reference channel B, "channel A phase shift"	Vavg and period used for the calculation
Phase (B)	reference channel A, "channel B phase shift"	Vavg and period used for the calculation



1 or 2 automatic measurements per channel can be selected. The automatic cursors are assigned to the last selected measurement which is displayed in the first position on the screen. When the measurement is possible, the automatic cursors provide an additional indication, see the table above.

Oscilloscope Mode

The "Measurement" menu (cont'd)

Measurement conditions

- The measurements are made on the entire depth of the acquisition.
- Any modification of the signal causes an update of the measurements. These are refreshed at the same rhythm as the acquisition.
- The accuracy of the measurements is optimal if two complete periods of the signal are displayed.

Presentation of automatic measurements

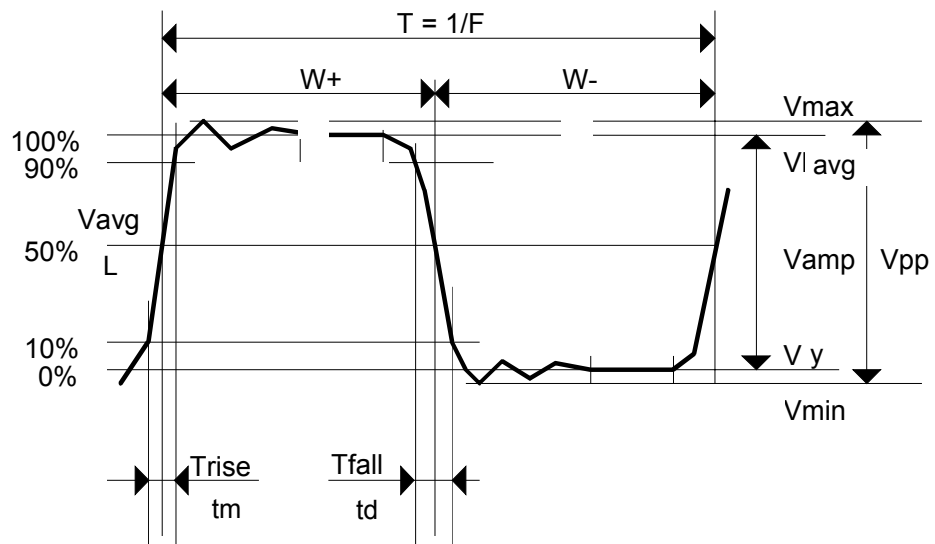

- Positive overshoot = $[100 * (V_{max} - V_{high})] / V_{amp}$
- Negative overshoot = $[100 * (V_{max} - V_{low})] / V_{amp}$

- $V_{rms} = \left[\frac{1}{n} \sum_{i=0}^{i=n} (y_i - y_{GND})^2 \right]^{1/2}$

- $V_{avg} = \frac{1}{n} \sum_{i=0}^{i=n} (y_i - y_{GND})$

Y_{GND} = value of the point representing zero Volts

Phase measurement

Automatic measurement of one trace's phase compared with the other trace.

No phase measurements are possible on the M channel.

The choice of the measurement configuration window (channel A or B) on which the phase measurement is selected conditions the reference channel for the phase-shift measurement.

If the selection is made from the channel A window: channel B becomes the reference channel and the oscilloscope displays the phase shift of channel A in relation to channel B.

Oscilloscope Mode The "Memory" menu

The "Memory" menu



Press this key.

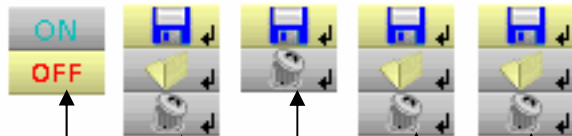

- activates/deactivates the reference display
See example, p. 44.
- manages stored traces (.trc)
- manages stored traces (.txt)
☞ **The .txt traces cannot be reloaded on the HandScope but can be used in Spreadsheet software.**
- manages memorised configurations (.cfg)
☞ **The .cfg files are specific to the HandScope and are not compatible with the brand's other instruments.**
- manages memorised screenshots (.bmp)

Definition of the common icons



gives access to the window for recording a trace, a text trace or a stored configuration or screenshot.



gives access to the trace, configuration or screenshot recall window.



gives access to the window for deleting a trace, configuration, text trace, stored configuration or screenshot.

The file name is generated automatically (e.g. trace_01.txt, etc.)

Oscilloscope Mode

The "Memory" menu (cont'd)

Storage capacity The memory's capacity is 2 MB (500 kb of which used by File System) and it can be used to store traces, screenshots, configurations and measurement files (p. 66).



The file names are generated automatically by incrementing the file index from 00 to 99 (e.g.: trace-00.TXT, trace-01.TRC, setup-03.CFG, screen-10.BMP, meter-20.TXT ...).

When the memory is full the message "Error: Memory Full!" appears.

There are 3 possible solutions:

- delete the files one by one using the "Memory" option (→ data is lost).
- transfer the files to a PC via SX-METRO or remote commands (see programming instructions).
- completely reinitialise the memory
 ↳ **Warning! All files will be lost.**



1. Turn off the instrument and press  and .
2. While keeping the keys pressed down, press on  and wait for the symbol opposite to appear.
3. The deletion takes about forty seconds.

Example

Trace reference Observation of a sinusoidal signal with amplitude modulation

The reference signal appears in light yellow. The amplitude signal is no longer the same as the reference.

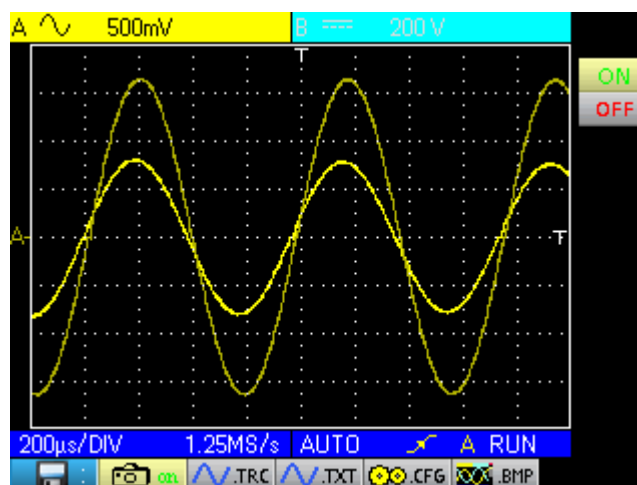

A reference memory is volatile; it is lost when the instrument is powered off, or when the channel or reference is deactivated.

Oscilloscope Mode The "Memory" menu (cont'd)

Description

Recording management

- of a .trc trace
- of a .txt trace
 - of a .cfg configuration
 - of a .bmp screenshot

Example:

Text zone indicating the name under which the file will be saved to the user.

Trace selection zone. The user chooses the trace to be saved.

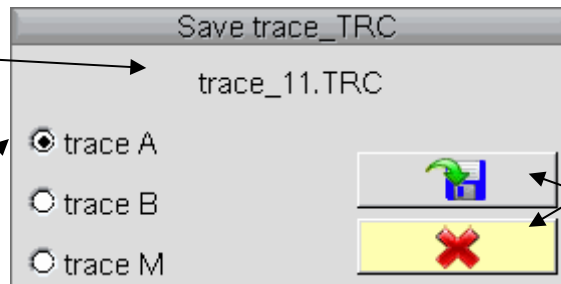

Confirm or Cancel buttons
Confirmation of elements

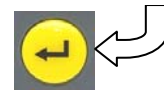

Recall management

- of a .trc trace
 - of a .cfg configuration
 - of a .bmp screenshot

Example:

List of .cfg files

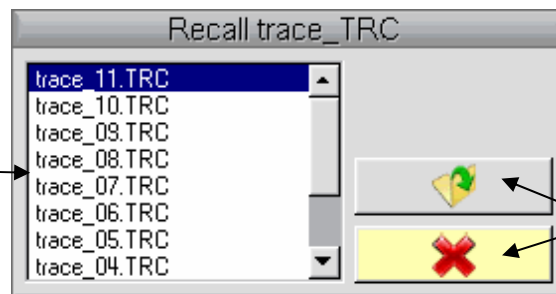

Confirm or Cancel buttons



- **A recalled .trc trace will be displayed on the M channel with a green background.**
- **A factory configuration called 'default.cfg' is used to return to the original factory settings.**

Deletion management

- of a .trc trace
- of a .txt trace
 - of a .cfg configuration
 - of a .bmp screenshot

Example:

List of .txt files

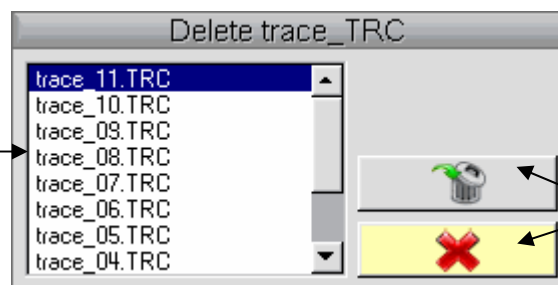

Confirm or Cancel buttons

Oscilloscope Mode

The "Tools" menu

The "Tools" menu



Press this key. This menu is the same in "Multimeter" and "Harmonic analyser" modes.

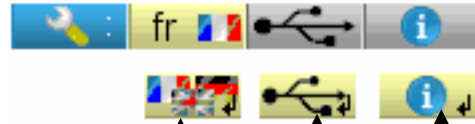

- selects the language:



- opens the "RS/USB Information" window:



- opens the "About..." window:

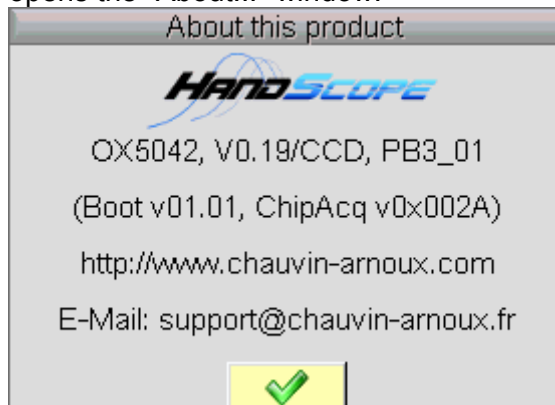

This windows gives information about

- the instrument name, the software / hardware version and the serial number
- the startup and acquisition programme versions
- the website to visit to obtain news on the METRIX instrument range,
- the customer support E-mail address to obtain answers to your questions concerning the instrument.

Oscilloscope Mode

The "Help" key

The "Help" key



Press this key to activate / deactivate the integrated help function.

In all modes it displays a help window for the current menu.

Example

Main title of the current help

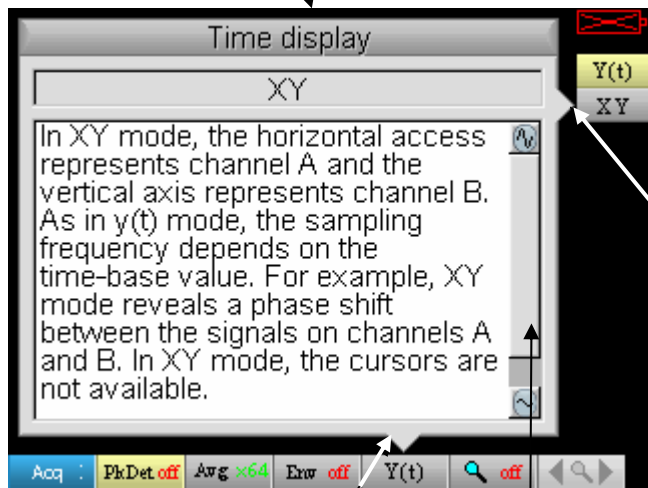

A Pointer placed opposite the tab of the secondary menu for which help is needed.

Pointer placed opposite the tab of the main menu.

Scroll bar; its position can be changed by using the vertical sensitivity keys:



Multimeter Mode

The keys



pressing this key selects the "**Multimeter**" mode; 2 independent 8,000-count digital multimeters are available.

6 "Menu" keys

Trigger



inactive in "**Multimeter**" mode.

Acquisition



inactive in "**Multimeter**" mode.

Tools



displays the main "**Tools**" menu, identical to the **Oscilloscope** mode, see p. 15.

Measurement



displays the main "**Measurement/Cursor**" menu, see p. 40.

Memory



displays the main "**Memory**" menu, see p. 43.

Help



displays the "**Help**" window, identical to the **Oscilloscope** mode, see p. 47.

3 keys

Channel A, B and
Math

Channel



- A single press **selects** channel "A" (or "B") and shows the corresponding menu.

Channel



- Pressing twice **deselects** the channel.

Function



inactive in "**Multimeter**" mode.

2 "Time base" keys



increases the recording time in the viewing window.



decreases the recording time in the viewing window.

2 "Sensitivity" keys



decreases the range of the last selected channel.



increases the range of the last selected channel.

2 functional keys



inactive in "**Multimeter**" mode.



The RUN/HOLD key **activates** or **deactivates** the Hold mode.

Multimeter Mode Display

Display

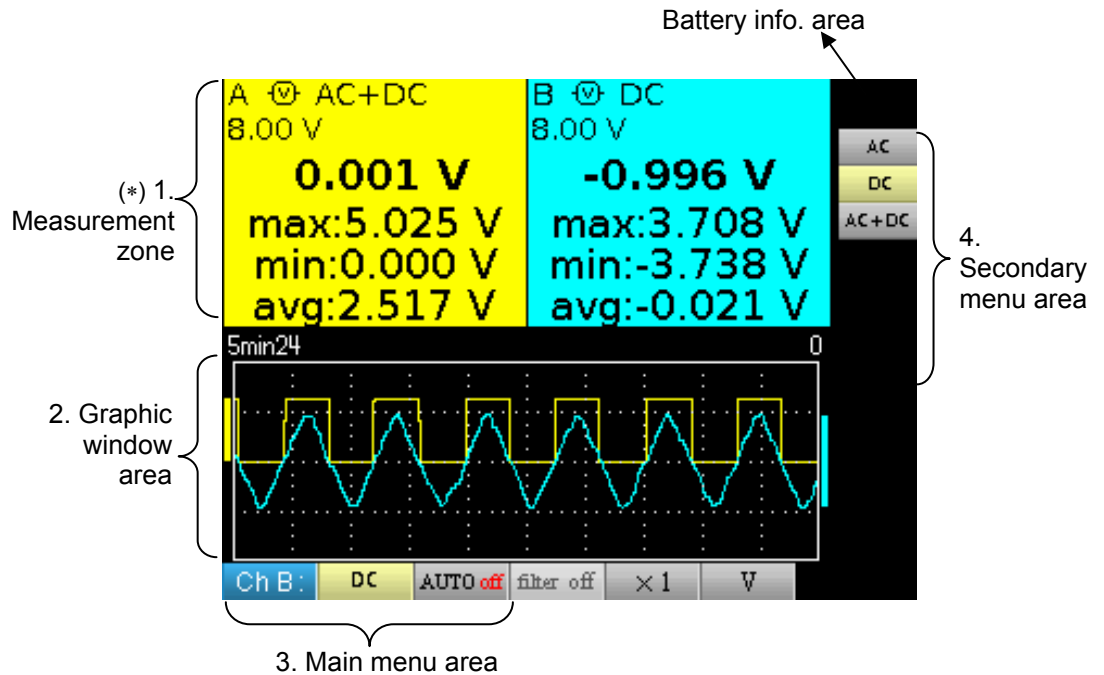

(*) *If the measurement is not possible, dotted lines will be displayed. If the channel is not validated the measurement will be replaced "-x-".*

1. Measurement zone

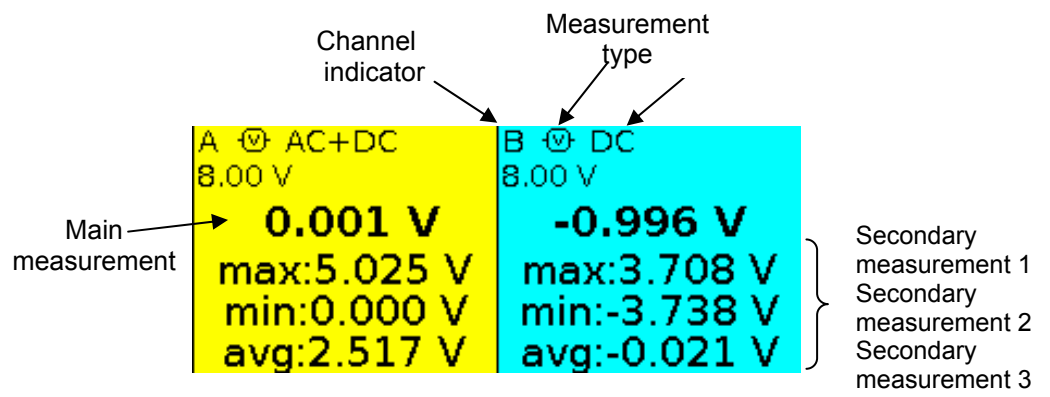

The direct data from channels A and B are displayed in this window:

- Channel indicator
- Coupling
- Filter
- Measurement type
- Main measurement
- Secondary measurement 1
- Secondary measurement 2
- Secondary measurement 3

Multimeter Mode Display (cont'd)

2. Graphic window area

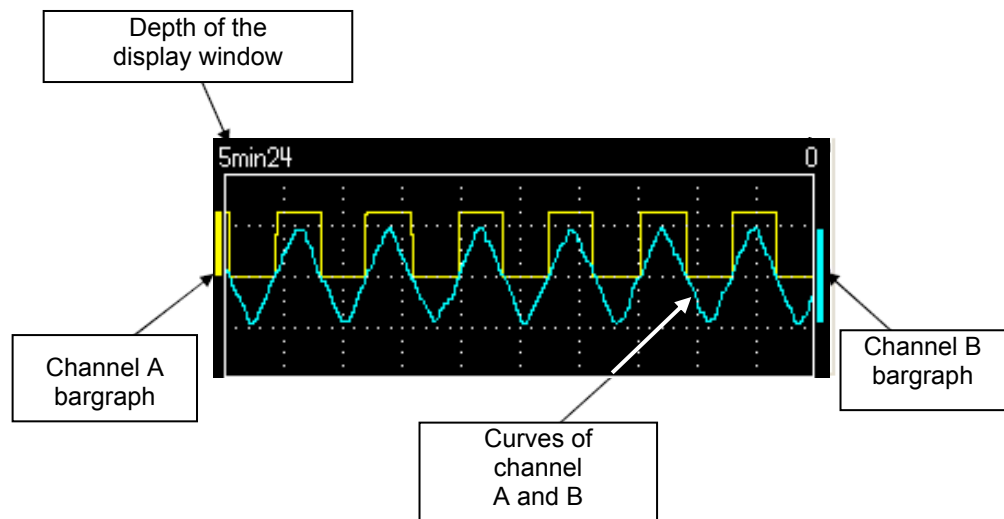

This window shows the measurement changes as a function of time, i.e.:

- the trend curves for the main measurement on each channel
- the reticle
- the operation duration
- a bargraph per channel

Trend curve

The trend curve is displayed over 270 points.

Observation duration

The depth of the window represents the observation duration: 2700 measurements are used.

Possible settings: 5'24", 15', 30', 1hr, 6hrs, 12hrs, 24hrs, 1 week, 1 month.

Bargraph

These bargraphs show the min and max measured values.



A range change reinitialises the bar graph at deletes the measurement trend curve.

3. Main menu area

4. Secondary menu area

Multimeter Mode The "Measurement" menu

The "Measurement" menu



Press this key.

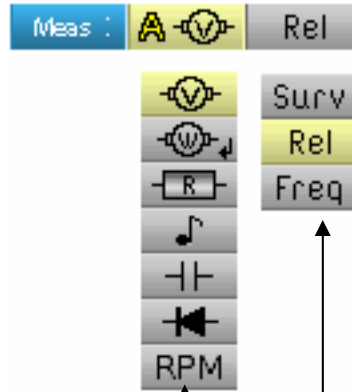

- selects the main measurement on channel A
- selects the secondary measurement displayed on the channels

Channel "B" is assigned to voltage measurement, when possible.

Description

Channel "A" main measurement



- Amplitude measurement
- Active power measurement
- Ohmmeter
- Continuity
- Capacitance meter
- Component test
- Rotation speed measurement (specific sensor)

Multimeter mode

The "Measurement" menu (cont'd)

Power measurement and dialogue window for "measurement selection"

When selecting  active power measurement, pressing on "Enter" displays the window below. You can thus choose the measurement type:

- Single-phase
- Balanced three-phase without N
- Balanced three-phase with N

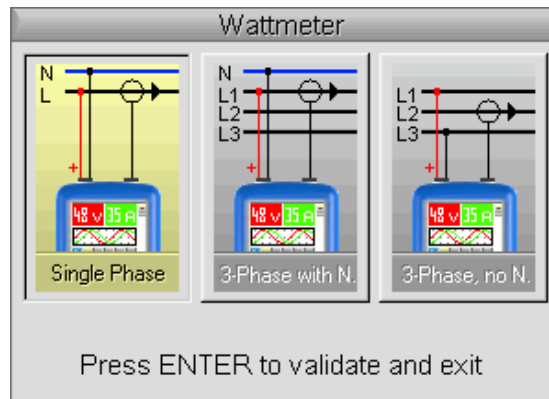



Display of the power measurement and forced tabs

The power measurement imposes the following settings:

- Channel A unit: V (volt)
- Channel B unit: A (amps)
- Channel A and B coupling: AC

Example

By default the power covers the measurement of channel A; pressing the  key is used to view the measurement of channel A, the power then covers the measurement of channel B and vice versa with the  key.

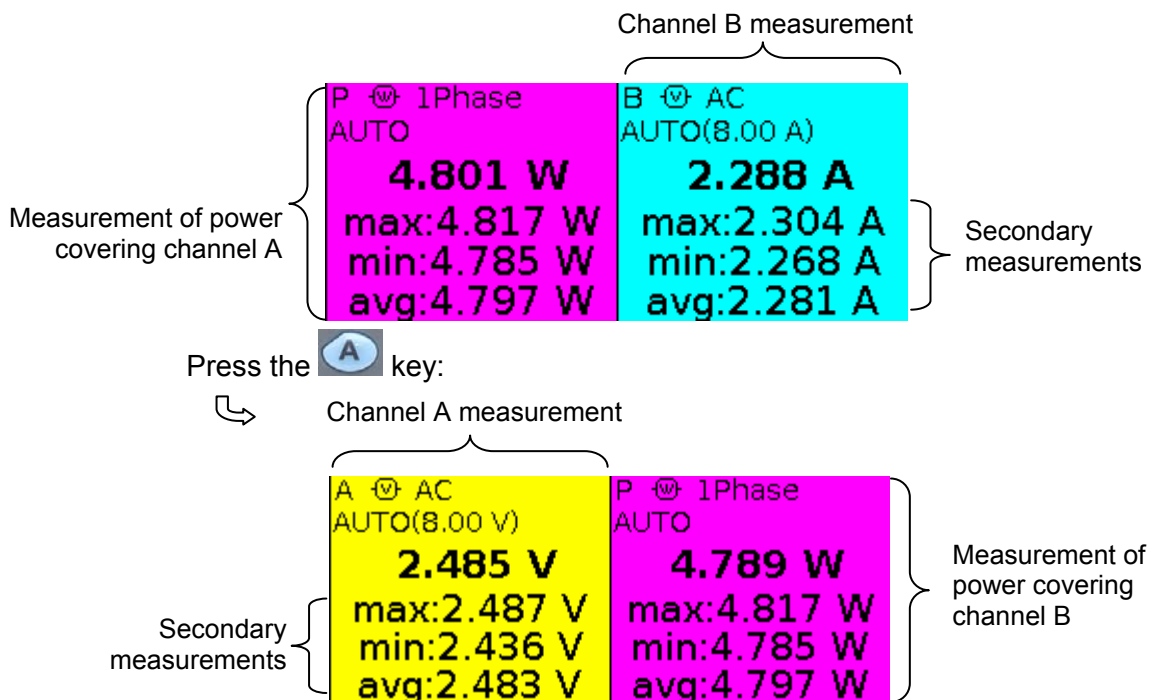

Multimeter Mode

The "Measurement" menu (cont'd)

Secondary measurement

selects the secondary measurement displayed on the channels:

Surv

activates the secondary monitoring measurement. This comprises three measurements:

- min → the minimum measured value
- max → the maximum measured value
- avg → the average value since the last reset

Rel

activates the relative secondary measurement. This comprises three measurements:

- rel → the difference between actual value and reference value
- ref → the reference value
- Δ → the difference in %

Freq

activates the secondary frequency measurement.



***The choice of secondary measurement is applied to all channels.
The secondary measurement validated by default is frequency.***



You can reset the secondary monitoring or relative measurements by:

- pressing  when the active main menu is the secondary measurement choice menu,
- by temporarily changing the secondary measurement,
- by deactivating and reactivating the channel,
- by changing the range.

Multimeter Mode

The Channel "A" or "B" menu

The Channel "A" or "B" menu



Press one of these two keys.

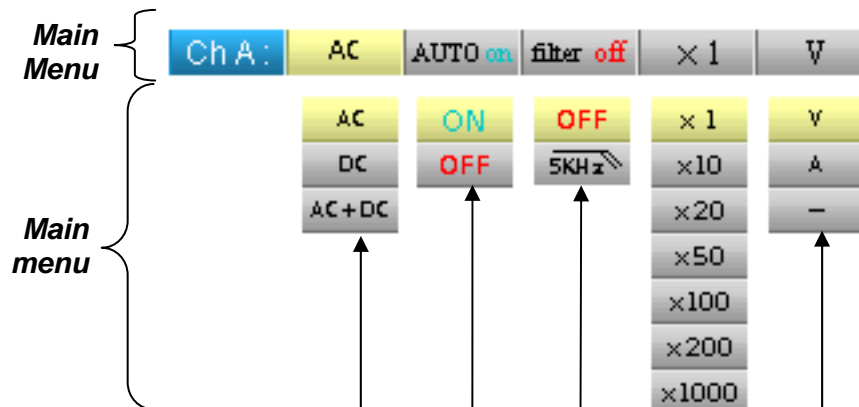

- (1) • selects the channel coupling (AC, DC, GND) — See example p. 24.
- (2) • activates or deactivates autorange
- (1) • selects the channel filter (OFF, 5 kHz)
- (1) • selects the channel sensor factor (x 1 to x 1000)
- (1) • selects the channel unit (Volt, Amps, -)

Notes

- (1) *These tabs are not accessible if the following types of measurement are validated:*
 - Capacitance meter
 - Ohmmeter
 - Component test
 - Continuity
 - RPM
- (2) *These tabs are not accessible if the following types of measurement are validated:*
 - Component test
 - Continuity
 - RPM

Multimeter Mode The Channel "A" or "B" menu (cont'd)

Example

Multimeter coupling

In voltmeter mode, 3 types of coupling are possible:

- AC is used to measure the VAC RMS voltage of the signal without its DC component,
- DC is used to measure the signal's VDC voltage,
- AC + DC gives the VAC + DC RMS voltage of the entire signal.

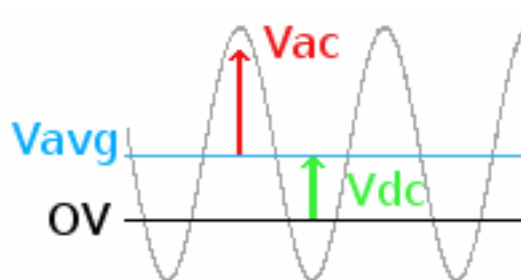

where:
$$V_{AC+DC} = \sqrt{V_{AC}^2 + V_{DC}^2}$$

Multimeter Mode

The "Memory" menu

The "Memory" menu This menu operates in exactly the same way as in the "Oscilloscope" mode.



Press this key.



- selects saved trace management (.txt)
- selects saved configuration management (.cfg)
- selects saved screenshot management (.bmp)

Harmonic Analyser Mode

The Keys



Pressing this key selects the "**Harmonic Analyser**" mode.

6 "Menu" keys



inactive in "**Harmonic Analyser**" mode.



displays the main "**Acquisition**" menu, see p. 36.



displays the main "**Tools**" menu, id. to the **Oscilloscope** mode, see p. 46.



inactive in "**Harmonic Analyser**" mode.



displays the main "**Memory**" menu, see p. 43.



displays the "**Help**" window, identical to the **Oscilloscope** mode, see p. 47.

3 keys

Channel "A" + "B" and Math



- A single press **selects** channel A (or B) and shows the corresponding menu.



- Pressing twice **deselects** the channel.



inactive in "**Harmonic Analyser**" mode.

2 "Time base" keys



inactive in "**Harmonic Analyser**" mode.



inactive in "**Harmonic Analyser**" mode.

2 "Sensitivity" keys



same as "**Oscilloscope**" mode, see p. 15.



same as "**Oscilloscope**" mode, see p. 15.

2 functional keys



same as "**Oscilloscope**" mode, see p. 15.



same as "**Oscilloscope**" mode, see p. 15.

Harmonic Analyser Mode Display

Visualisation

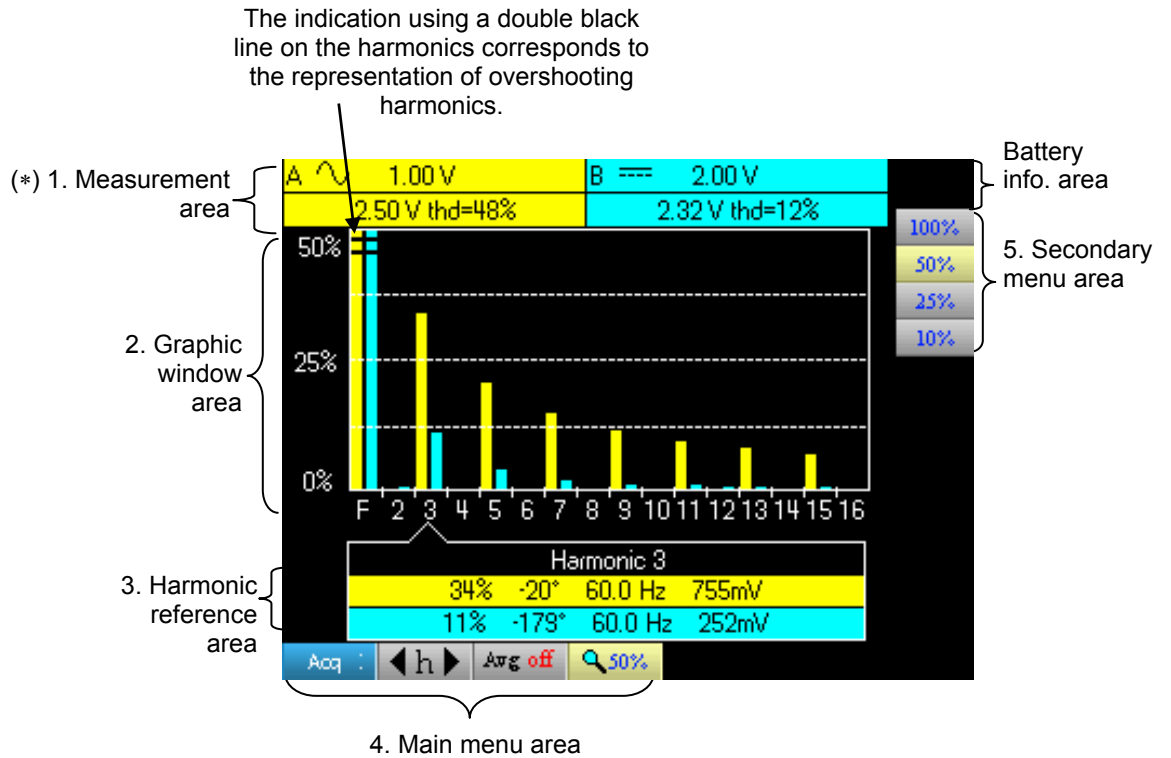

(*) *If no measurement is selected, or if the channel is not validated, the measurement will be replaced by dots.*

1. Measurement zone

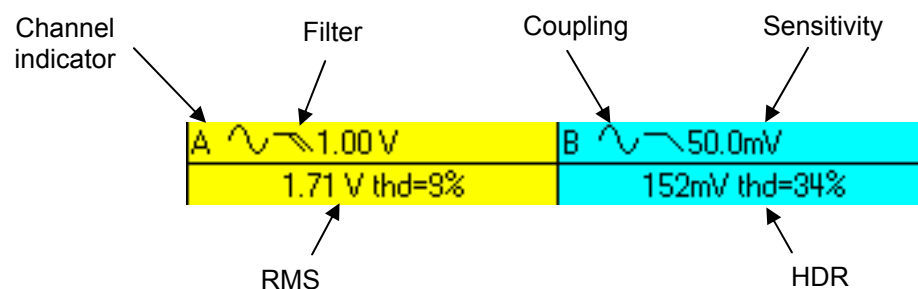

This window displays two measurements and contains data on the channels:

- Channel indicator
- Coupling
- Filter
- RMS voltage of the signal in V
- Total Harmonic Distortion (THD) in %

Harmonic Analyser Mode Display (cont'd)

2. Harmonic display area

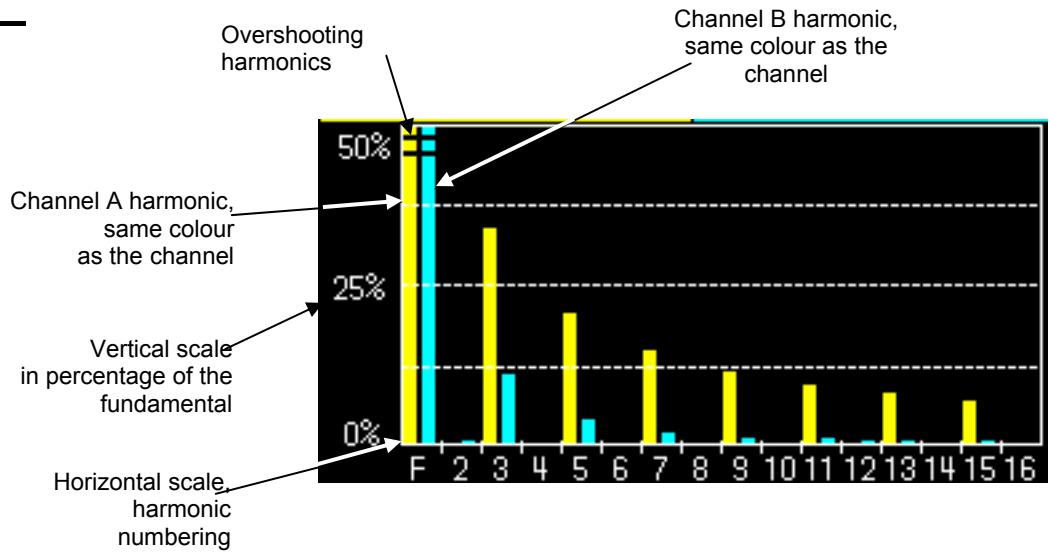

This area displays harmonics 1 to 16 of the validated channels in the form of a bar chart. The user can switch from the display of harmonics 2 to 16 to the display of harmonics 17 to 31. The max. vertical scale will depend on the zoom factor. The zoom factor can be modified using the Acq menu.

3. Harmonic reference area

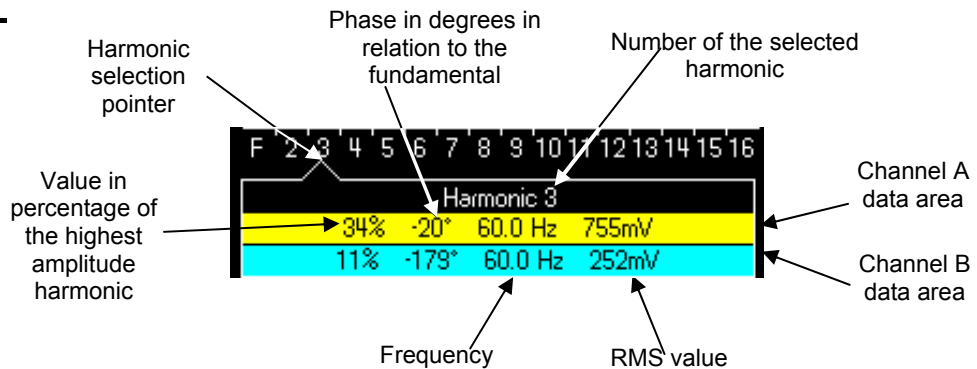

This window displays the specific measurements of the selected harmonic for each channel.

The following measurements are displayed:

- the value in % of the highest amplitude harmonic
- the phase in degrees in relation to the fundamental
- the frequency in Hz
- the RMS voltage in V

The title of the group corresponds to the selected harmonic.

A different background colour will differentiate between channel A and channel B measurements.

4. and 5. Main and secondary menu areas

Harmonic Analyser Mode The Channel "A" or "B" menu

The Channel "A" or "B" menu

This menu operates in exactly the same way as in the "Oscilloscope" mode.



Press one of these two keys.

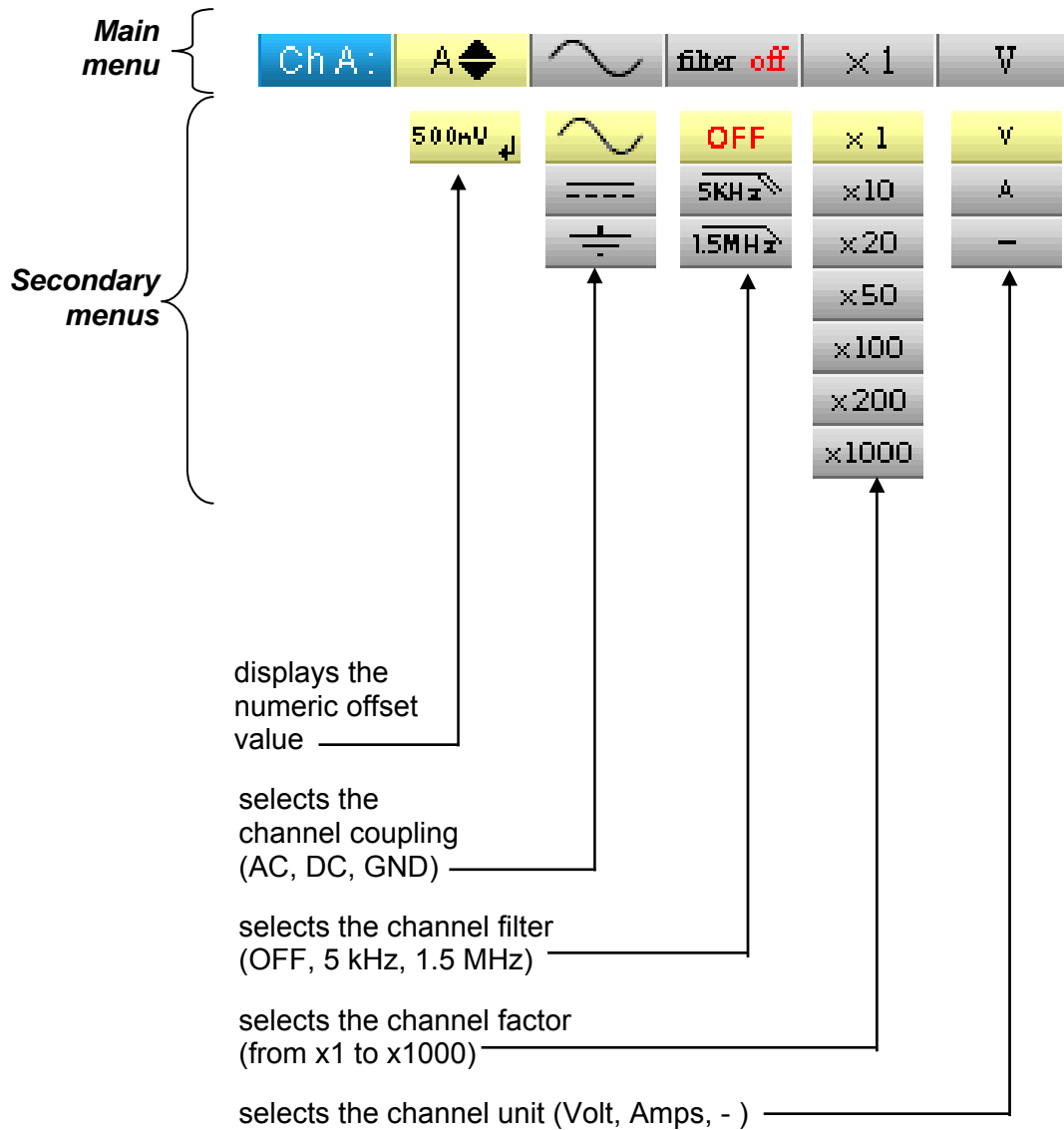

Harmonic Analyser Mode The "Acquisition" menu

The "Acquisition" menu



Press this key.

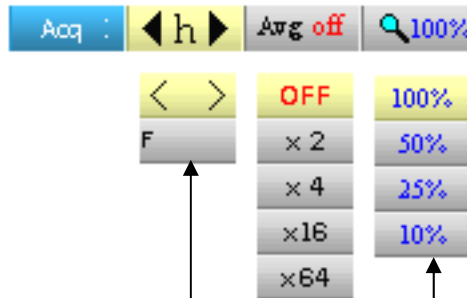

- adjusts and displays the number of the selected harmonic



Exit tab

- Averaging
Identical to "Oscilloscope" mode
- selects the vertical zoom factor

100%	100 % of the fundamental
50%	50 % of the fundamental
25%	25 % of the fundamental
10%	10 % of the fundamental

The user can change the vertical scale of the harmonics display area so that it is easier to view the harmonics with low amplitude compared with the fundamental.

Harmonic Analyser Mode The "Memory" menu

The "Memory" menu This menu operates in exactly the same way as in the "Oscilloscope" mode.



Press this key.



- manages stored configurations (.cfg)
- manages stored screenshots (.bmp)

Remote programming

Presentation

The oscilloscope can be programmed remotely from a computer:

- either using the SX-METRO software,
- or using basic standardised commands that comply with the IEEE488.2 standard and the SCPI protocol.

This remote programming is used to:

- Configure the instrument
- Perform measurements and retrieve the results
- Transfer files (traces, configuration, screenshots, etc.)

Here we will only describe the connection of the oscilloscope to SX-METRO. For all other use, refer to the remote programming instructions.

Connecting the oscilloscope

The dialogue between the instrument and the PC is carried out via the USB/optical link provided by the HX0056-Z cable.

- Connect the USB end of the cable to one of the PC USB ports (if necessary install the driver shipped with the cable).
- Connect the optical connector to the oscilloscope after first powering it up.
- Open SX-METRO; select USB communications and wait for communications to be established (in the event of a problem, refer to the SX-METRO instructions).

Technical Specifications "Oscilloscope" Mode

Only the assigned tolerance or limit values are guaranteed
(after 30 minutes to adapt to temperature).
Values without tolerances are given for information purposes only.

Vertical deflection

Specifications	OX 5022	OX 5042
Number of channels	2 channels	
Vertical calibres	5 mV to 200 V/div. <i>Variation by jumps (no continuous variable factor)</i>	
BW at -3 dB	20 MHz	40 MHz
	☞ <i>Measured on a load of 50 Ohms with a 6 div. amplitude signal</i>	
Max input voltage	600 V _{DC} , 600 V _{RMS} Derating: -20 dB per decade from 100 kHz to 40 MHz	
Types of inputs	Safety connector: class 2, insulated inputs (metal or plastic BNC, to be determined)	
Dynamics of vertical offset	± 5 div. on all calibres	
Input coupling	AC : 10 Hz to 20 MHz DC : 0 to 20 MHz GND : reference	AC : 10 Hz to 40 MHz DC : 0 to 40 MHz GND : reference
Bandwidth limit	1.5 MHz	5 kHz
Rise time	approx. 17.5 ns	approx. 8.75 ns
Cross-talk between channels	> 60 dB same sensitivity on both channels	
Response to 1 kHz and 1 MHz rectangular signals	Positive or negative overshoot Overshoot ≤ 4 %	
Vertical display resolution	± 0.26 % of the full scale at the best (without measurements, without cursors)	
Accuracy of peak-to-peak gains	± 2 % with averaging of 4 at 1 kHz	
Accuracy of vertical measurements in DC with offset and averaging of 16	± [2,5 % (reading) + 13 % (sensitivity) + 0.5 mV] <i>Applies to the following measurements: V_{min}, V_{max}, V_{low}, V_{high}, V_{avg}, vertical cursors</i>	
Accuracy of vertical measurements in AC without offset at 1 kHz and averaging of 16	± [2 % (reading) + 2 % (sensitivity)] <i>Applies to the following measurements: V_{amp}, V_{RMS}, Over+, Over-</i>	
Sensors	The attenuation factor is to be applied in the channel menu.	
Vertical ZOOM function on an acquired or stored curve	none	
Electrical safety without accessories	600 V, CAT III, double insulation	
Max. voltages	floating: 600 V, CAT III from 50 to 400 Hz between channels: 600 V, CAT III from 50 to 400 Hz	
Input impedance	1 MΩ ± 0.5 % approx. 17 pF	

Technical Specifications (cont'd)

"Oscilloscope" Mode

Horizontal deflection (time base)

Specifications	OX 5022	OX 5042
Time base calibres	from 25 ns to 200 s/div. such that: <ul style="list-style-type: none"> Actual time: from 200 s/div. to 5 μs/div. ETS : from 2.5 μs/div. to 125 ns/div. Zoomed ETS: 50 ns/div. and 25 ns/div. For time bases from 200 s/div. to 100 ms/div., the samples are displayed as soon as the trigger is present.	
Accuracy of the time base	\pm [500 ppm + 0.04 div.] (equ. to \pm [0.05 % + 0.04 div.])	
Sampling frequency	50 MS/s in real time	
	2 GS/s in ETS	
Accuracy of time measurements	\pm [(0.02 div.) x (time/div.) + 0.01 x reading + 5 ns]	
Horizontal ZOOM	Zoom factor: x 1, x 2 and x 5 In ZOOM mode there is the same time-base calibre sequence as in normal mode. The horizontal screen resolution is 540 points for 10 divisions.	
XY Mode	The bandwidths are identical in X and Y (see §. Vertical offset). As in the standard mode, the sampling frequency depends on the time base value.	
Phase error	< 3°	

Trigger circuit

Trigger sources	A, B	
Trigger mode	Automatic/Triggered/One shot (roll if the time base \geq 100 ms/div.)	
Trigger coupling with band limitation	DC (default): 0 to 20 MHz HFreject: 0 to 10 kHz LFreject: 10 kHz to 20 MHz	DC (default): 0 to 40 MHz HFreject: 0 to 10 kHz LFreject: 10 kHz to 40 MHz
Trigger slope	Rising or falling edge	
Trigger sensitivity (without noise rejection)	1.2 div. peak-to-peak from DC to 20 MHz	1.2 div. peak-to-peak from DC to 40 MHz
Noise rejection	\pm 1.5 div.	
Vertical trigger Variation range	\pm 8 div.	
Horizontal trigger Variation range	Trig after delay (from -10 div. up to the left of the screen)	
Trigger type	edge	
	pulse width	< t \approx t > t

Technical Specifications (cont'd)

"Oscilloscope" Mode

Acquisition chain

Specifications	OX 5022	OX 5042
Resolution of the ADC	9 bits	
Maximum sampling frequency	50 MS/s in real time / 1 converter per channel	
Transient capture	Minimum width for detectable glitches: > 20 ns	
MIN/MAX mode	1250 MIN/MAX couples	
Depth of acquisition memory	2500 pts per channel	

Formats of the different files

Specifications	OX 5022	OX 5042
Backup memory	Managed in a file system Total size 2 MB (500 kB of which used by File System) to store various objects: <ul style="list-style-type: none"> - traces - configurations - screenshots 	
Trace files acquired in SCOPE mode Extension: .TRC ⓘ : <i>trace-xx.TRC</i>	Binary format Size: ≈ 10 kB	
Configuration files Extension: .CFG ⓘ : <i>setup-xx.CFG</i>	Binary format Size: ≈ 1 kB	
image files Extension: .BMP ⓘ : <i>screen-xx.BMP</i>	Binary format Size: .BMP: ≈ 75 kB	
Files containing text Extension: .TXT ⓘ : <i>trace-xx.TXT</i> ⓘ : <i>meter-xx.TXT</i>	Text format The .TXT extension files can contain measurements made using the instrument's different acquisition modes.	
	Trace acquired in SCOPE mode Size: ≈ 25 kB.	
	Measurement in Meter mode Size: ≈ 80 kB.	

Technical Specifications (cont'd)

"Oscilloscope" Mode

Measurement processing

<p>Mathematical functions</p>	<p>Choice from:</p> <ul style="list-style-type: none"> - opposite, - addition - subtraction, - multiplication, - division. <p>The display is adjusted using a factor: / 5, / 2, x 1, x 2, x 5</p>	
<p>Automatic measurements</p>	<p>Time measurements</p> <ul style="list-style-type: none"> rise time fall time positive pulse negative pulse duty cycle period frequency phase (A % B) meter 	<p>Level measurements</p> <ul style="list-style-type: none"> DC voltage RMS voltage peak-to-peak voltage amplitude max. voltage min. voltage upper plateau lower plateau overshoot
<p>Cursor or automatic measurements</p> <p><i>Accuracy of vertical measurements</i></p> <p><i>Accuracy of time measurements</i></p> <p><i>Operation</i></p>	<p>Display on 4 digits</p> <p>$\pm [2.5 \% (\text{reading}) + 13 \% (\text{sensitivity}) + 0.5 \text{ mV}]$</p> <p>$\pm [0.02 \times (t/\text{div.}) + 0.01 \% (\text{reading}) + 5 \text{ ns}]$</p> <p>The cursors are attached to the curve.</p>	

Technical Specifications (cont'd)

"Oscilloscope" Mode

Display

Specifications	OX 5022	OX 5042
Display Screen	3.5" TFT LCD (colour display)	
	Backlit LED	
Resolution	1/4 VGA, i.e. 320 horizontal pixels x 240 vertical pixels	
Window viewed in normal mode	Complete memory: 2500	
Horizontal ZOOM	540 pts from the 2500 in the complete memory	
Display modes	<p><i>Entire acquisition</i> Display of all the samples acquired in a burst with linear interpolation between 2 acquired points (default mode)</p> <p><i>Min/Max</i> Display of min and max on each X axis acquired in a burst.</p> <p><i>Envelope</i> Display of min and max on each X axis acquired in several bursts.</p> <p><i>Averaging</i> Factors from: none, 2, 4, 16, 64</p>	
Reticle	Complete and borders	
Screen indications	<p><i>Triggering</i> Position of the triggering level (with coupling and overshoot indicator) Position of the Trigger point on the zoom indicator and the upper edge of the screen (with overshoot indicators)</p> <p><i>Traces</i> Trace identifiers, trace activation: position, sensitivity, earth reference, high and low overshoot indicators if traces outside screen</p>	

Other

1/10th Sensor calibration signals	Form: rectangular Amplitude: 0 - 3 V Frequency: \approx 1 kHz ☞ Connect the sensor cold point to the cold point of the sensor calibration output
Autoset	<p><i>Search time</i> < 5 s</p> <p><i>Frequency range</i> > 30 Hz</p> <p><i>Amplitude range</i> 30 mVpp to 400 Vpp</p> <p><i>Duty cycle limits</i> from 20 to 80 %</p>

Technical Specifications (cont'd) "Accessories"

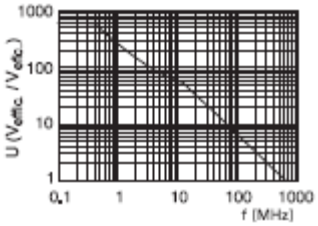
 <p>1/10 Sensor</p>	<p>Measurement category 600 V CAT III Bandwidth DC to 500 MHz Input capacitance 12 pF Compensation range 12 pF to 25 pF Rise time 0.9 ns Input impedance 10 MΩ DERATING see opposite Accessories wire holder and earth crocodile clip</p>
<p>BNC Banana adapter</p>	<p>Measurement category 600 V CAT III Diameter 4 mm</p>
<p>Measurement cable</p>	<p>Measurement category 600 V CAT III Diameter 4 mm Termination test probe</p>
<p>Current clamp</p>	<p>Measurement category 600 V CAT III Connection BNC</p>
<p>Active thermocouple adapter</p>	<p>Adapter for K Thermocouple Measurement range -40° C to 1000° C -40° K to 1800° K Transformation ratio 1 mV/° C 1 mV/° K Choice of unit ° C or ° K Accuracy [-40° C → 0° C] ± (0.8 % ± 2 mV) Accuracy [0° C → 400° C] ± (0.5 % ± 1 mV) LED low battery Particularity differential measurement Connection banana Operating range 0 to 50° C, < 70 % RH Battery 9 V</p>
<p>Infrared temperature sensor</p>	<p>Measurement range -30 to 550° C Transformation ratio 1 mV/° C Accuracy ± (2 % ± 2° C) Distance between 5 cm and 30 cm Connection banana Operating range 0 to 50° C, < 80 % RH Battery 9 V</p>
<p>Tachometer</p>	<p>Measurement range 6 to 120 000 RPM Signal pulse Accuracy ± 0,5 % Distance between 5 cm and 30 cm Connection banana Operating range 0 to 50° C, < 80 % RH Battery 9 V</p>

Technical Specifications "Multimeter" Mode

Only the assigned tolerance or limit values are guaranteed (after 30 minutes to adapt to temperature). Values without tolerances are given for information purposes only.

Display	8000 points for voltmeter		
Entry Impedance	1 M Ω		
Max input voltage	600 Vrms sine and 600 VDC, without sensor		
Max. floating voltage	600 Vrms up to 400 Hz CAT III		
DC measurement			
Ranges	0.8 V	8 V	80 V 800 V
Resolution	0.1 mV	1 mV	10 mV 0.1 V
Accuracy	$\pm (1 \% + 20 D)$ in DC from 10 % to 100 % of scale		
Common mode rejection	> 60 dB to 50 or 60 Hz		
AC and AC+DC measurements			
Ranges	0.6 V 0.8 V	6 V 8 V	60 V 80 V 600 Vrms sine 800 Vpeak
Resolution	0.1 mV	1 mV	10 mV 0.1 V
Coupling accuracy AC + DC	$\pm (1 \% + 20 D)$ from DC to 5 kHz of 10 % to 100 % of scale \rightarrow 580 Vrms $\pm (2 \% + 20 D)$ from 5 to 10 kHz id. $\pm (3 \% + 20 D)$ from 10 to 50 kHz id.		
AC	$\pm (1 \% + 20 D)$ from 40 Hz to 5 kHz id. $\pm (2 \% + 20 D)$ from 5 to 10 kHz id. $\pm (3 \% + 20 D)$ from 10 to 50 kHz id.		
Common mode rejection	> 60 dB to 50 or 60 Hz		
Resistance measurement	On channel 1		
Ranges (end of scale)	Ohmmeter	Resolution	Measurement current
	80 Ω	0.01 Ω	0.5 mA
	800 Ω	0.1 Ω	0.5 mA
	8 k Ω	1 Ω	5 μ A
	80 k Ω	10 Ω	5 μ A
	800 k Ω	100 Ω	500 nA
	8 M Ω	1000 Ω	50 nA
	32 M Ω	10 k Ω	50 nA
Accuracy	$\pm (2 \% + 10 D + 0.2 \Omega)$ from 10 % to 100 % of scale		
Voltage in open circuit	$\approx 3 V$		
Continuity measurement	On channel 1		
Beeper	< 30 $\Omega \pm 5 \Omega$		
Measurement current	$\approx 0.5 mA$		
Beeper response	< 10 ms		
Diode test	On channel 1		
Voltage	in open circuit $\approx + 3.3 V$		
Accuracy	$\pm (1 \% + 10 D)$		
Measurement current	$\approx 0.6 mA$		

Technical Specifications (cont'd)

"Multimeter" Mode

Capacitance measurement	<i>On channel 1</i>		
<i>Ranges</i>	Capacitance meter	Resolution	Measurement current
	5 mF	1 μ F	500 μ A
	500 μ F	0.1 μ F	500 μ A
	50 μ F	0.01 μ F	500 μ A
	5 μ F	1 nF	500 μ A
	500 nF	100 pF	50 μ A
	50 nF	10 pF	2 μ A
	5 nF	1 pF	2 μ A
<i>Accuracy</i>	$\pm (2 \% + 10 D + 200 \text{ pF})$ from 10 % to 100 % of scale		
<i>Cancellation of serial and parallel R</i>	Parallel R > 10 k Ω Use the shortest possible cables.		
Frequency measurement	20 Hz to 50 kHz on sine and square signals 20 Hz to 20 kHz on a triangle signal Accuracy: 0.3 %		
RPM Measurement	from 240 to 120,000 RPM Pulse measurement: > 10 μ s exceeding 1.5 V with a hysteresis of 1 V. One pulse corresponds to one rotation.		

Operating modes

<i>Relative mode</i>	Display in relation to a REF base measurement	The Relative, Monitoring and Frequency modes are exclusive.
<i>Monitoring (statistic)</i>	On all measurement values MAX MIN AVG	
<i>Frequency</i>	Possible display of the frequency in AC mode	
<i>Measurement history</i>	Display of the measurement = f (time) 5' (default), 15', 30', 1hr, 6hrs, 12hrs, 24hrs, day, month	
<i>RUN</i>	Start measurements	
<i>HOLD</i>	Freeze the measurement	

Technical Specifications (cont'd)

"Multimeter" Mode

Display	
<i>in numeric form</i>	- of the main measurement → large scale display - of a secondary measurement → small scale display The secondary measurement can be selected from the menu.
<i>Graphic trace</i>	History of measurements over time Presentation of the measurements in the form of an amplitude bar chart
<i>Number of measurements represented on the trace</i>	2700

Network "Harmonic Analysis" Mode

Display of Harmonics	
<i>All the Harmonics</i>	from 2 to 16 + Fundamental on page 1 from 17 to 31 + Fundamental on page 2
Fundamental frequency of the signal analysed	from 40 to 450 Hz
Measurement accuracy	
<i>Fundamental level</i>	± (2.5 % + 15 D)
<i>Level of harmonics</i>	± (3.5 % + 15 D)
<i>Harmonic distortion (THD)</i>	± 4 % (calculated on the first 40 harmonics)

Communication interfaces

USB/optical Interface	The oscilloscope can communicate with a computer via a USB link using the HX0056-Z adapter cable.
<i>Specifications of the optical link</i>	Bauds speed selection: 57600 Parity selection: none Word length selection: 8 bits Selection of the nr. of stop bits: 1 stop bit Selection of the protocol: none (no protocol)

General Specifications

Environment

- Reference temperature 18° C to 28° C
- Operating temperature 0° C to 40° C
- Storage temperature - 20° C to 60° C
- Indoor use
- Altitude < 2000 m
- Relative humidity < 80 % up to 35° C

Power Supply

- **Rechargeable batteries** 6 x 1.2 V ; 2700 mAh
 Type NiMH
 Charge time approx. 3hr
 Min. battery life approx. 5hr45
 Max. battery life approx. 8hr30
 (1 channel deactivated, AC coupling)
- **External power supply** Battery charger
 Network voltage 98 V to 264 V
 Frequency from 50 to 60 Hz
 Consumption < 11 VA in operation
 ≅ 12 VA during fast battery charging
 Voltage 12 VDC
 Power 1.25 A
 Polarity 
 Use Battery charging or oscilloscope operation



Safety Compliant with IEC 61010-1 and IEC 61010-2-030 :

- Insulation class 2
- Pollution degree 2
- Overvoltage category for "measurement" inputs: 600 V CAT III

EMC This instrument complies with the IEC 61326-1 standard. It has been tested for industrial environments (class A). In other environments and under special conditions compatibility may be difficult to ensure.

- Emission Class A
- Immunity Influence: 0.5 div. in the presence of an electromagnetic field of 10 V/m

Mechanical Specifications

Box

- Dimensions 214 mm x 110 mm x 57 mm
- Oscilloscope weight 0.960 kg with battery
- Power supply weight 0.160 kg
- Ingress protection IP 54

Packaging

- Dimensions 25 cm x 16.5 cm x 14.5 cm

Supply

Accessories

shipped with the appliance

- Operating and Programming Manual on CD-ROM - in 5 languages
- External power supply
- 6 NiMH 1.2V 2.7 Ah rechargeable batteries
- HX0105 bag
- 1/10 600 V CAT III sensor
- BNC adapter to Ø 4mm connectors
- Ø 4 mm "banana/banana" connectors red black
- Test probe red black
- Alligator clamp red black
- Serial-USB optical cable + Driver (CK model only)

delivered as options

Accessories

- 600V isolated measuring set, with 1/10 probe 600V CATIII and BNC adapter to Ø 4 mm bananasHX0108
- 20AAC/DC current clamp, 600 V CAT II, 100 mV/A.....HX0102
- Infrared temperature sensor (1 mV/° C) CA1871..... P01651610Z
- Active thermocouple adapter (1 mV/° C or 1mV/° K) CA801 P01652401Z
- Active differential thermocouple adapter (1 mV/° C or 1 mV/° K) CA803 P01652411Z
- Tachometer CA1711 P01102082
- BNC M/BAN F4 600 V adapters (x 2)HX0107

Other

- Generator circuit for oscilloscopesHX0074
- SX-METRO application softwareSXMETRO