

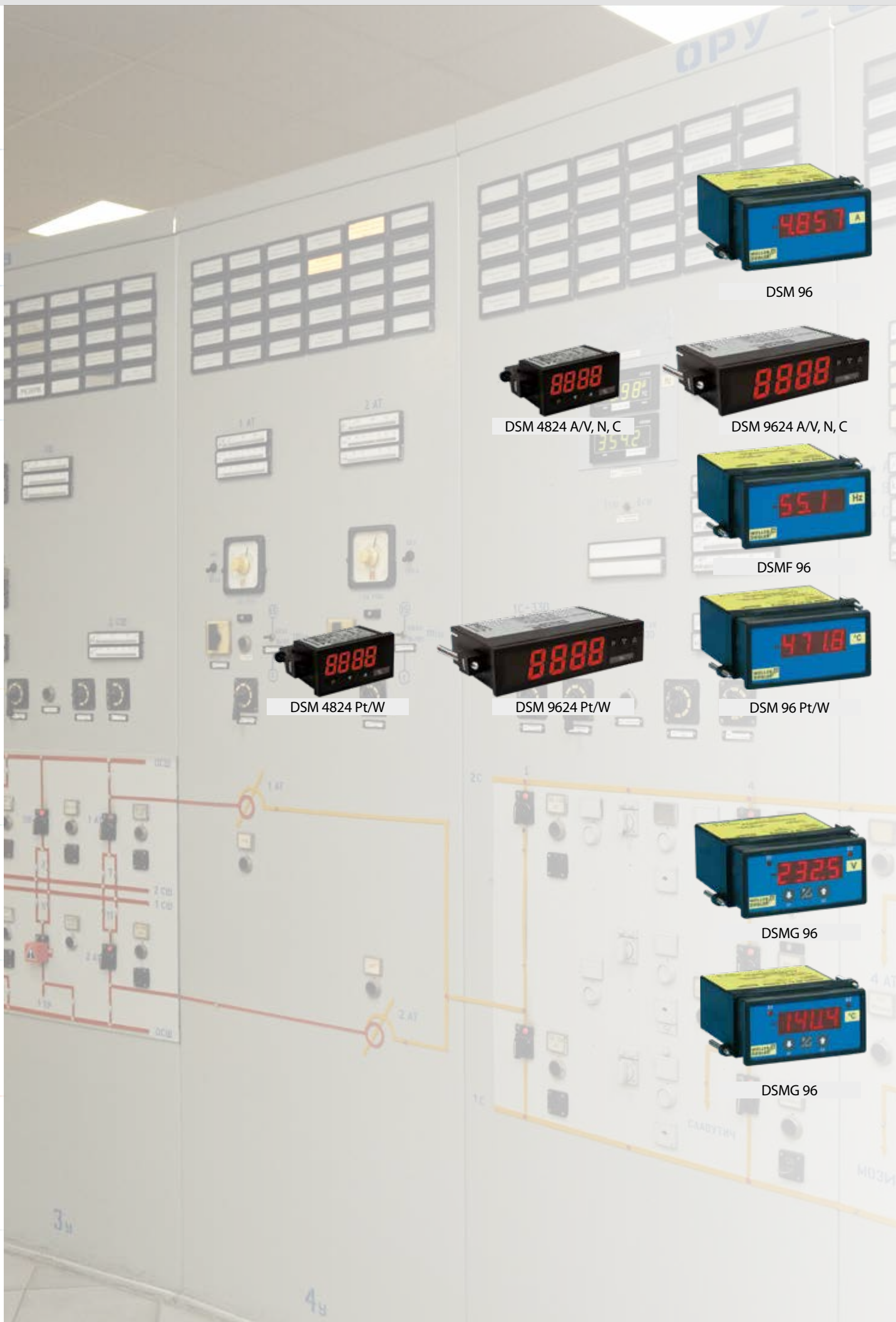

## PANEL METERS DIGITAL

TECHNICAL INFORMATION



DSM 96



DSM 4824 A/V, N, C



DSM 9624 A/V, N, C



DSMF 96



DSM 4824 Pt/W



DSM 9624 Pt/W



DSM 96 Pt/W



DSMG 96



DSMG 96

## Panel meters digital

General description		Page 4
<b>Direct and alternating current and voltage</b>		
Direct current	DSM 96 4-digit	Page 6
Direct voltage		
Alternating current AC + DC True RMS		
Alternating voltage AC + DC True RMS		
<b>Heavy current and weak current variable</b>		
Direct current, direct voltage	DSM 9624 A/V 5-digit	Page 8
Direct current, direct voltage (standard signal)	DSM 9624 N / 4824 N 4-digit	Page 8
Direct voltage at shunt resistor	DSM 9624 C / 4824 C 4-digit	Page 8
<b>Frequency</b>		
	DSMF 96 4-stellig	Page 10
<b>Process variables</b>		
Temperature Temperature resistance thermometer Pt 100	DSM 96 Pt 4-digit	Page 12
Resistance	DSM 96 W 4-digit	Page 12
Temperature Temperature resistance thermometer Pt 100	DSM 9624 Pt / DSM 4824 Pt 4-digit	Page 14
Resistance	DSM 9624 W / DSM 4824 W 4-digit	Page 14

## Panel meters digital with limit values

<b>Heavy current and weak current variable</b>		
Direct current	DSMG 96 4-digit	Page 16
Direct voltage		
Alternating current AC + DC True RMS		
Alternating voltage AC + DC True RMS		
<b>Process variables</b>		
Temperature Temperature resistance thermometer Pt 100	DSMG 96 Pt 4-digit	Page 18
Resistance	DSMG 96 W 4-digit	

# General description

## Application

Digital panel meters are used for the display and monitoring of various measuring signals in heavy-current and weak-current technique as well as different process variables. Our digital measuring instruments may directly be used for current, voltage, frequency, resistance or temperature measurements.

Furthermore, a measured value may be displayed in a switch room over larger distances using an upstream measuring transducer. Digital indicators may be applied everywhere where increased accuracy is required and reading errors are to be avoided.

## Type and function

The digital measuring instruments are distinguished by 4-digit and 5-digit types according to their display capacity. In case of a 4-digit display, the largest presentable value is 9999, in case of a 5-digit display that value is 99999.

The values are shown in a 7-segment LED display. The front panel may be marked in a customer-specific or order-specific manner. Also, the zero point may be elevated or suppressed. A maximum of two limit values may be monitored, the minimum and maximum measured value may be stored and displayed. Decimal points, dark switching of the last digit, zero point as well as display range may be changed after removing the front panel.

## Special features

DSM 96

- high accuracy of up to 0.1 % +/- 1 digit of measured value
- auxiliary voltages for 230 V AC, 24 V DC, 36-265 V or 6-30 V AC + DC are available
- 4 kV test voltage between measuring input and all available auxiliary voltages

DSM 9624 und DSM 4824

- high accuracy of up to 0.1 % +/- 1 digit of measured value
- min./max.-value recording
- adjustable support points
- display flashing at limit value exceedance/undershooting
- tara-function

## Technical data

General data	EMC	DIN EN 61 326
	(for DC auxiliary voltage and multi voltage)	DIN EN 61 326 class A
	Mechanical strength	DIN EN 61 010 part 1
	Electrical safety	DIN EN 61 010 part 1 housing insulated, protection class II, DSM 96 <ul style="list-style-type: none"> <li>● for working voltages up to 300 V (phase to neutral) pollution degree 2, measurement category CAT III</li> <li>● or working voltages up to 600 V (phase to neutral) pollution degree 2, measurement category CAT III</li> </ul> DSM 9624 auxiliary voltage 100-240 V AC and 230 V AC <ul style="list-style-type: none"> <li>● for working voltages up to 300 V (phase to neutral) pollution degree 2, measurement category CAT III</li> </ul> DSM 9624/4824 auxiliary voltage 24 V DC <ul style="list-style-type: none"> <li>● for working voltages up to 100 V (phase to neutral) pollution degree 2, measurement category CAT II</li> </ul>
	Isolation	DIN EN 61 010 part 1, 3,7 kV 50 Hz, 10 s
	Air and creep distances	DIN EN 61 010 part 1
	Protection level	DIN EN 60 529, housing IP 50, terminals IP 10

## Test report

Up to 10 testpoints (depending on type)



## Dimensions

for digital panel meters

DSM 96

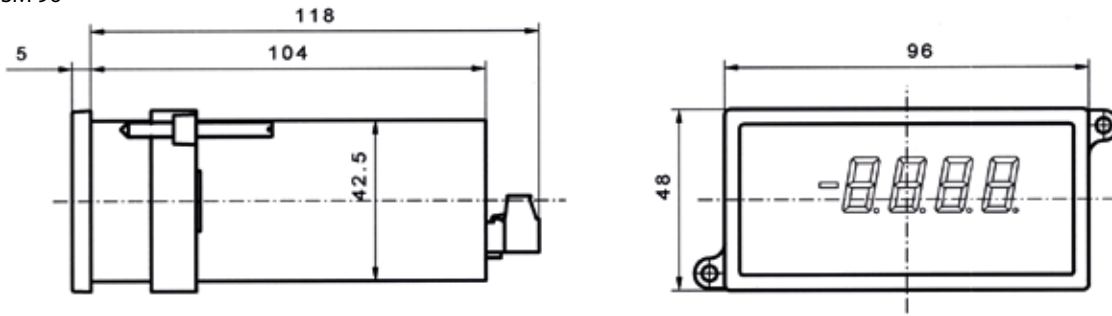

DSM 9624 (5 digit)

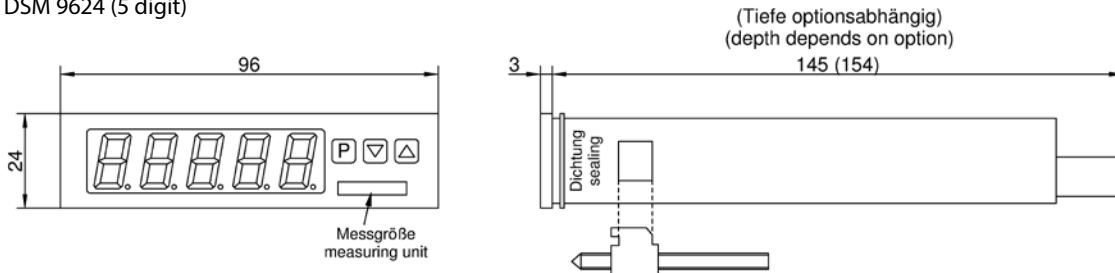

DSM 9624 (4 digit)

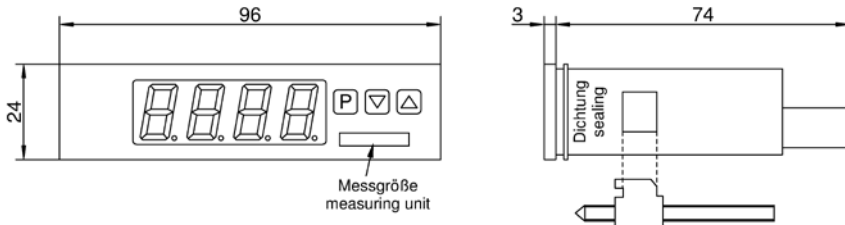

DSM 4824



Dimensions in brackets for DC version!

1 Measuring transducers

2 Mains and limit monitoring

3 Energy meters

3

4 Panel meters digital

Panel meters analog

5

6 Meas. instruments for top hat rail mounting

7 Universal measuring instruments

8 Current transformers

9 Shunts

9

10 Test apparatus

10



Also available in black.  
Please specify separately.



## Digital measuring instruments

4 digit, 96 x 48 mm  
for direct and alternating current and voltage  
(True RMS)

Type:  
**DSM 96**



### Application

The digital measuring instrument DSM 96 is used for measuring direct current, direct voltage, alternating current and alternating voltage as well as for indicating transformed non-electrical variables.



### Function

The measurand is sent to a 4-digit A/D converter via series resistors and shunts (in case of alternating current via an rms rectifier). The conversion is made following the „Dual Slope“ principle. The values are indicated by 7-segment low-power LED displays. A hold function may be achieved by connecting two ports. The zero point compensation is done automatically. Decimal points, dark switching of the last digit, zero point as well as display range may be changed after removing the front panel.

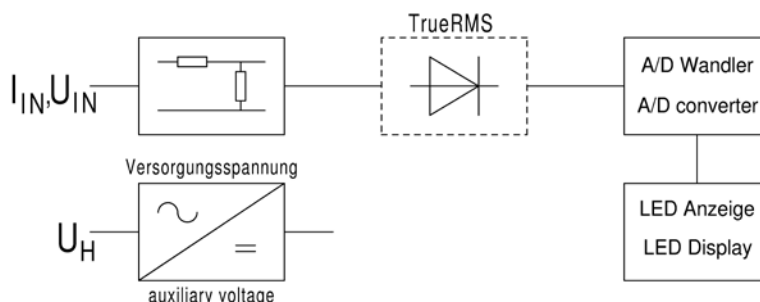

### Technical data

Display	LED seven-segment low-power, height 13mm, red; 4-digit
Decimal points	adjustable on front panel using DIP switch
Dark switching	of last digit, on front panel using DIP switch
Polarity	by negative (-) display
Resolution	maximum display +/- 9999 digit
Sampling rate	approx. 3 measurements per second
Measuring principle	Dual Slope integration
Accuracy	± 0,1 % of measured value ± 1 digit for direct voltage ± 0,2 % of measured value ± 2 digit for direct current ± 0,2 % of measured value ± 2 digit for alternating current variables of arbitrary waveform, rms value up to crest factor 4, DC, 40-1000 Hz
Hold function	by connecting terminals 1 + 4
Temperature range	-15 °C to +20 °C to +30 °C to +55 °C
Temperature influence	< 0,05 % at 10 K
Overload capacity	voltage 10-fold, max. 850 V, current 10-fold up to 20 mA, above 2-fold
Test voltage	4 kV between measuring input and auxiliary voltage
IP code	Housing IP 50, terminals IP 10
Connection	plug-in 12-pin terminal block, screw terminal max. 2,5 mm <sup>2</sup>
<b>Auxiliary voltage</b>	
Standard	230 V AC ± 20 %, 45-65 Hz, 3 VA
Options	24 V DC, -15 % to +25 %, 2,5 W 6-30 V AC + DC or 36-265 V AC + DC, 2,5 VA



## Types and variants

<b>Type</b>	DSM 96 4-digit		
Front panel (mm)	96 x 48		
Housing (mm)	90 x 42,5		
Cut-out (mm)	92 x 45		
Installation depth (mm)	118		
Weight (kg)	0,35		
<b>Type of current</b>	<b>Measuring range</b>	<b>Display</b>	<b>Internal resistance</b>
Direct voltage DC	± 60 mV	1000 bis 9999	> 100 M Ω
	± 100 mV	1000 bis 9999	> 100 M Ω
	± 1 V	1000 bis 9999	> 1 M Ω
	± 10 V	1000 bis 9999	1 M Ω
	± 100 V	1000 bis 9999	1 M Ω
	± 600 V	1000 bis 9999	1 M Ω
Direct current DC	± 1 µA	1000 bis 9999	100 k Ω
	± 10 µA	1000 bis 9999	10 k Ω
	± 100 µA	1000 bis 9999	1 k Ω
	± 1 mA	1000 bis 9999	100 Ω
	± 10 mA	1000 bis 9999	10 Ω
	± 20 mA	1000 bis 9999	10 Ω
	4 - 20 mA	1000 bis 9999	10 Ω
	± 100 mA	1000 bis 9999	1 Ω
	± 1 A	1000 bis 9999	0,1 Ω
	± 5 A	1000 bis 9999	0,02 Ω
Direct and alternating voltage DC + AC True RMS	0 - 100 mV	1000 bis 9999	> 100 M Ω
	0 - 1 V	1000 bis 9999	100 k Ω
	0 - 10 V	1000 bis 9999	1 M Ω
	0 - 100 V	1000 bis 9999	1 M Ω
	0 - 600 V	1000 bis 9999	1 M Ω
Direct and alternating current DC + AC True RMS	0 - 1 mA	1000 bis 9999	100 Ω
	0 - 10 mA	1000 bis 9999	10 Ω
	0 - 100 mA	1000 bis 9999	1 Ω
	0 - 1 A	1000 bis 9999	0,1 Ω
	0 - 5 A	1000 bis 9999	0,02 Ω
<b>Surcharges</b>	Outside of standard series		
	Different measuring unit (e.g. mm/h)		
	Auxiliary voltage	24 V DC	
		6-30 V AC + DC	
		36-265 V AC + DC	

1 Measuring transducers

2 Mains and limit monitoring

3 Energy meters

4 Panel meters digital

5 Panel meters analog

6 Meas. instruments for top hat rail mounting

7 Universal measuring instruments

8 Current transformers

9 Shunts

10 Test apparatus



## Connection

**Front view**  
(without front panel)

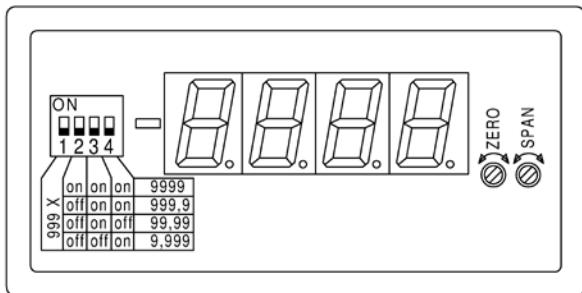

**Rear view**

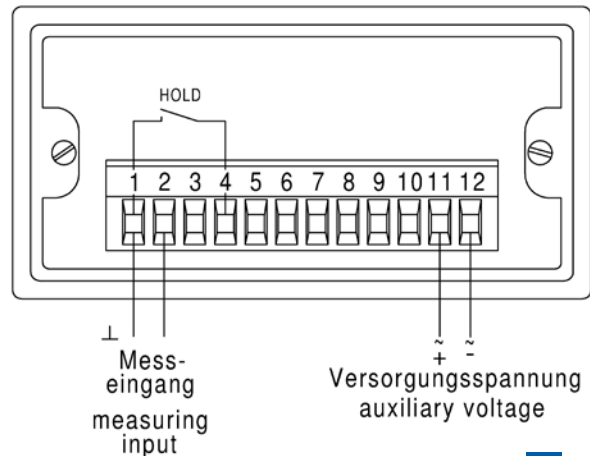



## Digital measuring instruments

4 and 5 digit, 96 x 24 mm and 48 x 24 mm for direct current and direct voltage

Type:

**DSM 9624 N, DSM 9624 A/V, DSM 9624 C, DSM 4824 N, DSM 4824 C**



### Application

The digital measuring instruments DSM 9624 N, DSM 4824 N and DSM 9624 A/V are used for measuring direct current variables as well as for the indication of transformed non-electrical parameters. Types DSM 9624 C and DSM 4824 C are used for measuring at electrical shunts.



### Function

The panel meters serve as 4-digit or 5-digit display for direct voltage or direct current signals and as visual limit monitoring via the display. Programming is done via three front keys. An integrated programming interlock prevents unrequested changes of the parameter and can be unlocked again via an individual code. The electrical connection is at the rear via plug-in terminals. Further selectable functions like the recall of the min./max.-value, a zero point slowdown, a direct change of the limit value in operating mode and additional measuring supporting points for linearization are integrated into the device.



### Technical data

Types	DSM 9624 N, DSM 9624 A/V, DSM 9624 C, DSM 4824 N, DSM 4824 C
Display	LED seven-segment low-power, DSM 9624: height 14mm, red; DSM 4824: height 10mm, red N and C: 4 digit adjustable from -1999 to 9999 A/V: 5 digit adjustable from -19999 to 99999
Decimal points	adjustable
Measuring range	adjustable via appropriate connection the rear side
Polarity	by negative (-) display
Overflow	horizontal bars above
Underflow	horizontal bars below
Limit values	optical display flashing at exceedance or undershooting
Resolution	approx. 18 bit at 1 s measuring time
Measuring time	0,1 to 10 s
Measuring principle	U/F-conversion
Accuracy	0/4-20 mA, 0-10 V DC: 0,1 % of measuring range, $\pm 1$ digit remaining measuring ranges: 0,5 % of measuring range, $\pm 1$ digit
Temperature range	-20 °C to 0 °C to +50 °C to +80 °C
Temperature influence	100 ppm/K
Test voltage	auxiliary voltage 100-240 VAC and 230 VAC: 2,5 kV 24 VDC: 1 kV
Auxiliary voltage	DSM 4824 N and C 24 VDC $\pm 10\%$ (max. 1 VA) DSM 9624 N and C 4-stellig 230 VAC $\pm 10\%$ (max. 3 VA) ● Option 24 VDC $\pm 10\%$ (max. 1 VA) DSM 9624 A/V 5-digit 100-240 VAC 50/60 Hz, DC $\pm 10\%$ (max. 10 VA)
IP code	at the front IP65, rear side IP00
Connection	plug-in screw terminal, max. 2,5mm <sup>2</sup>
Material	housing: PC polycarbonate, black sealing: EPDM, 65 shore, black
Installation	screw mounting





## Types and variants

Types	DSM 9624 N / DSM 9624 A/V / DSM 9624 C	DSM 4824 N / DSM 4824 C
Front panel (mm)	96 x 24	48 x 24
Housing (mm)	91,7 x 21,7	44,4 x 21,6
Cut-out (mm)	92 x 22,2	45 x 22,2
Installation depth (mm)	N and C max. 74; A/V max. 154	54
weight (kg)	N and C 0,15; A/V 0,25	0,1

Type DSM 9624 A/V	Measuring range selectable via connection	Display	Internal resistance
Direct current	±1 A	-19999 to 99999	0,2 Ω
Direct voltage	± 300 V	-19999 to 99999	1 MΩ

Type DSM 9624 N DSM 4824 N	Measuring range selectable via connection	Display	Internal resistance
Direct current	± 20 mA	-1999 to 9999	100 Ω
	4-20 mA	-1999 to 9999	100 Ω
Direct voltage	± 10 V	-1999 to 9999	200 kΩ

Type DSM 9624 C DSM 4824 C	Measuring range selectable via connection	Display	Internal resistance
Direct voltage	60 mV	-1999 to 9999	12 kΩ
at shunt resistor	150 mV	-1999 to 9999	30 kΩ

Type DSM 9624 A/V	auxiliary voltage 100-240 VAC
Type DSM 9624 N	auxiliary voltage 230 VAC/24 VDC
Type DSM 9624 C	auxiliary voltage 230 VAC/24 VDC
Type DSM 4824 N	auxiliary voltage 24 VDC
Type DSM 4824 C	auxiliary voltage 24 VDC

Other measuring ranges on request.



## Connection

### DSM 9624 A/V

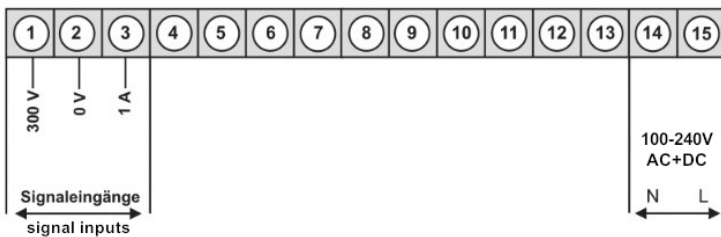

### DSM 9624 N

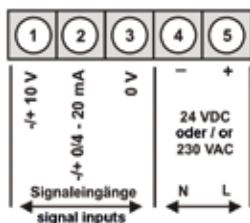

### DSM 9624 C

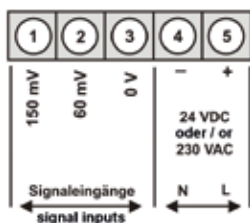

### DSM 4824 N

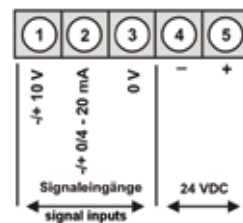

### DSM 4824 C

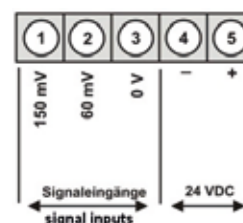



Also available in black.  
Please specify separately.

## Digital measuring instruments

4-digit, 96 x 48 mm  
for frequency

Type:  
**DSMF 96**



### Application

The digital measuring instrument DSMF 96 is used for measuring the frequency of alternating voltage as well as for the measurement of the pulsed direct voltage signals.



### Function

The measurand passes via resistors to a pulse shaper and then to a 4-digit A/D converter. The conversion is made following the „Dual Slope“ principle. The values are indicated by 7-segment low-power LED displays. A hold function may be achieved by connecting two ports. The zero point compensation is done automatically. Decimal points, dark switching of the last digit, zero point as well as display range may be changed after removing the front panel.

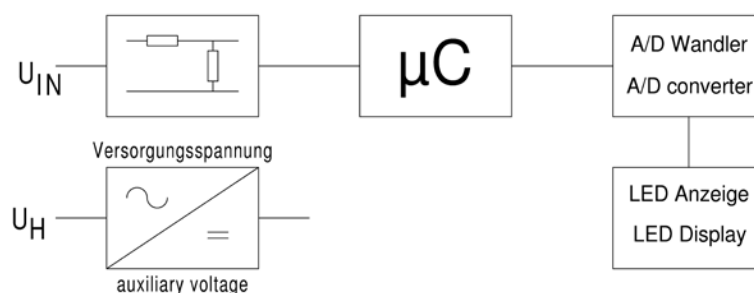

### Technical data

Display	LED seven-segment low-power, height 13mm, red; 4-digit
Decimal points	adjustable on front panel using DIP switch
Dark switching	of last digit, on front panel using DIP switch
Overflow	by negative (-) display
Resolution	maximum display +/- 9999 digit
Sampling rate	approx. 3 measurements per second
Measuring principle	Dual Slope integration
Accuracy	± 0,5 % of measured value +/- 2 digit for arbitrary waveform
Hold function	by connecting terminals 1 + 4
Temperature range	-15 °C to +20 °C to +30 °C to +55 °C
Temperature influence	< 0,05 % at 10 K
Overload capacity	voltage 10-fold, max. 850 V, current 10-fold up to 20 mA, above 2-fold
Test voltage	4 kV between measuring input and auxiliary voltage
IP code	Housing IP 50, terminals IP 10
Connection	plug-in 12-pin terminal block, screw terminal max. 2,5 mm <sup>2</sup>
<b>Auxiliary voltage</b>	
Standard	230 V AC ± 20 %, 45-65 Hz, 3 VA
Options	24 V DC, -15 % to +25 %, 2,5 W 6-30 V AC + DC or 36-265 V AC + DC, 2,5 VA



## Types and variants

<b>Types</b>	DSMF 96 4-digit			
Front panel (mm)	96 x 48			
Housing (mm)	90 x 42,5			
Cut-out (mm)	92 x 45			
Installation depth (mm)	118			
weight (kg)	0,35			
<b>Type of current</b>	Measuring range	Display	Measuring voltage	Internal resistance
Alternating voltage or pulsed direct voltage	0 - 1000 Hz	0 - 999,9 Hz	5 - 50 V	50 k $\Omega$
	0 - 1000 Hz	0 - 999,9 Hz	50 - 500 V	500 k $\Omega$
<b>Surcharges</b>	Outside of standard series			
	Different measuring unit (e.g. mm/h)			
Auxiliary voltage	24 V DC			
	6-30 V AC + DC			
	36-265 V AC + DC			



## Connection

**Front view**  
(without front panel)

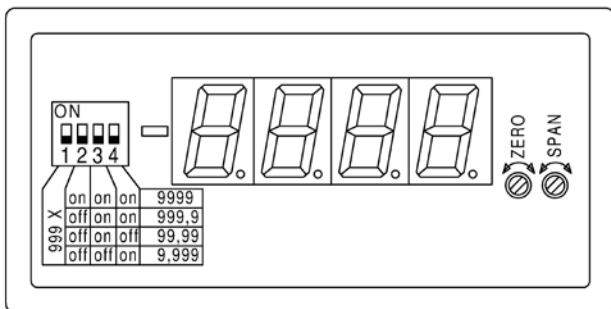

**Rear view**

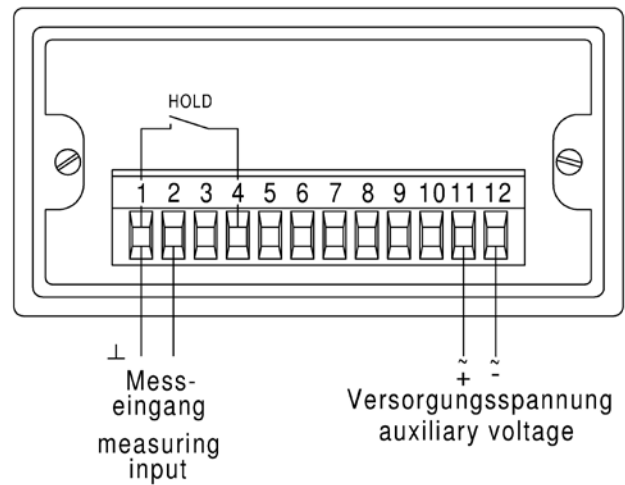



Also available in black.  
Please specify separately.

## Digital measuring instruments

4-digit, 96 x 48 mm  
for temperature and resistance

Type:  
**DSM 96 Pt / W**

### Application

The digital measuring instrument DSM 96 Pt is used for measuring the temperature in connection with a resistance thermometer Pt 100. Type DSM 96 W is designed for measuring resistances.

### Function

The measurand is converted into a direct voltage in an evaluation circuit and fed to a 4-digit A/D converter. The conversion is made following the „Dual Slope“ principle. The values are indicated by 7-segment low-power LED displays. In case of line breakage of the Pt 100, the LED flashes. The measurement may be done in two-wire or three-wire technique. A hold function may be achieved by connecting two ports. The zero point compensation is done automatically. Decimal points, dark switching of the last digit, zero point as well as display range may be changed after removing the front panel.

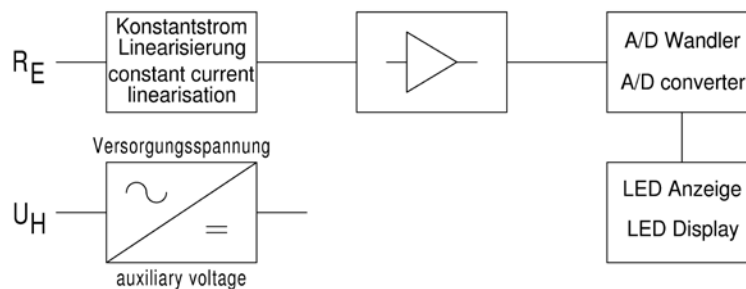

### Technical data

Types	DSM 96 Pt / W
Display	LED seven-segment low-power, height 13mm, red; 4-digit
Decimal points	adjustable on front panel using DIP switch
Dark switching	of last digit, on front panel using DIP switch
Sensor current	max. 3 mA
Sensor voltage	max. 4 V
Two-wire technique	max. input lead resistance 10 $\Omega$ (adjustment using „ZERO“ -potentiom.)
Three-wire technique	max. 100 $\Omega$ input lead resistance symmetrical
Polarity	by negative ( - ) display
Overflow	flashing LED
Resolution	maximum display +/- 9999 digit
Sampling rate	approx. 3 measurement per second
Measuring principle	Dual-Slope integration
Accuracy	$\pm 0,2\%$ , $\pm 2$ Digit of measuring range
Hold function	by connecting terminals 1 + 4
Temperature range	-15 $^{\circ}\text{C}$ to +20 $^{\circ}\text{C}$ to +30 $^{\circ}\text{C}$ to +55 $^{\circ}\text{C}$
Temperature influence	< 0,05 % at 10 K
Test voltage	4 kV between measuring input and auxiliary voltage
IP code	housing IP 50, terminals IP 10
Connection	plug-in 12-pin terminal block, screw terminal max. 2,5 mm <sup>2</sup>
<b>Auxiliary voltage</b>	<b>Standard</b> 230 V AC $\pm 20\%$ , 45-65 Hz, 3 VA
	<b>Options</b> 24 V DC, -15 % to +25 %, 2,5 W
	6-30 V AC + DC or 36-265 V AC + DC, 2,5 VA



## Types and variants

Types	DSM 96 Pt, DSM 96 W	
Front panel (mm)	96 x 48	
Housing (mm)	90 x 42,5	
Cut-out (mm)	92 x 45	
Installation depth (mm)	118	
weight (kg)	0,35	
<b>DSM 96 Pt 4-stellig</b>	Messbereich	Anzeige
Temperaturmessung Pt 100	-60 bis +850 °C	-60,0 bis +850,0 °C
<b>DSM 96 W4-digit</b>	Measuring range	Display
Resistance measurement	an arbitrary value between	
3-wire circuit	0-100 Ω to 0-10 kΩ	1000 to 9999
2-wire circuit	0-100 Ω	1000 to 9999
	0-1 kΩ	1000 to 9999
	0-10 kΩ	1000 to 9999
<b>Surcharges</b>	Outside of standard series	
	Different measuring unit (e.g. mm/h)	
	Auxiliary voltage	24 V DC
		6-30 V AC + DC
		36-265 V AC + DC

In case of resistance measurement: Please specify 2-wire or 3-wire circuit in order!

1 Measuring transducers

2 Mains and limit monitoring

3 Energy meters

4 Panel meters digital

Panel meters analog

5 Meas. instruments for top hat rail mounting

6 Universal measuring instruments

7 Current transformers

8 Shunts

9 Test apparatus



## Connection

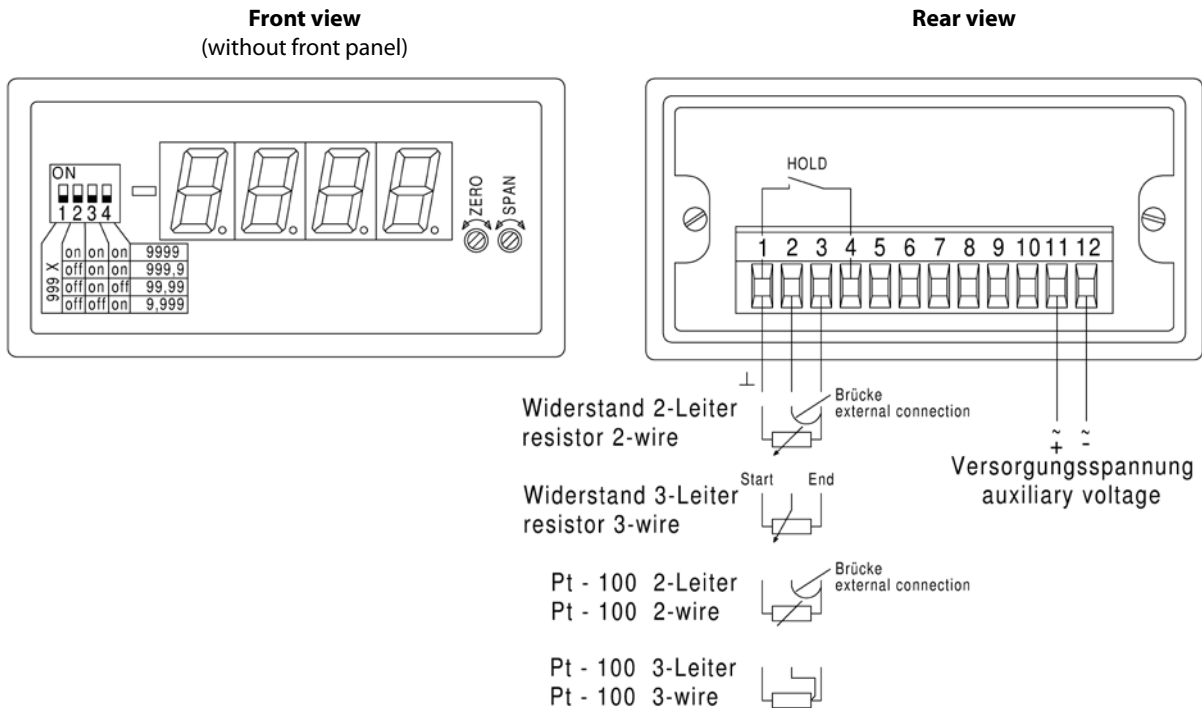



## Digital measuring instruments

4 digit, 96 x 24 mm and 48 x 24 mm for temperature and resistance

Type:

**DSM 9624 Pt, DSM 4824 Pt, DSM 9624 W, DSM 4824 W**



### Application

The digital measuring instruments DSM 9624 Pt and DSM 4824 Pt are used for measuring the temperature in connection with a resistance thermometer Pt 100. Types DSM 9624 W and DSM 4824 W are used for measuring resistances.



### Function

The panel meters serve as 4-digit display for Pt 100 sensor signals and resistance and as visual limit monitoring via the display. Programming is done via three front keys. An integrated programming interlock prevents unrequested changes of the parameter and can be unlocked again via an individual code. The electrical connection is at the rear via plug-in terminals. Further selectable functions like e.g. the recall of the min./max.-value, a zero point slowdown, a direct change of the limit value in operating mode and an impedance matching up to 20 °C are integrated into the device.



### Technical data

Types	DSM 9624 Pt, DSM 9624 4824 Pt, DSM 9624 W, DSM 4824 W	
Display	LED seven-segment low-power, DSM 9624: height 14mm, red; DSM 4824: height 10mm, red	
Decimal points	adjustable	
Overflow	horizontal bars above	
Underflow	horizontal bars below	
Limit values	optical display flashing at exceedance or undershooting	
Resolution	Pt100: approx. 0,1 °C resistance: ca. 18 bit at 1 s measuring time	
Measuring time	0,1 to 10 s.	
Measuring principle	U/F-conversion	
Accuracy	Pt 100: 0,1 % of measuring range, +/- 1 digit resistance: 0,5 % of measuring range, +/- 1 digit	
Temperature range	-20 °C to 0 °C to +60 °C to +80 °C	
Temperature influence	100 ppm/K	
Test voltage	auxiliary voltage 230 VAC: 2,5 kV    24 VDC: 1 kV	
Auxiliary voltage	DSM 4824 Pt and W	24 VDC ± 10 % (max. 1 VA)
	DSM 9624 Pt and W	230 VAC ± 10 % (max. 3 VA)
	● Option	24 VDC ± 10 % (max. 1 VA)
IP code	at the front IP65, rear side IP00	
Connection	plug-in screw terminal, max. 2,5mm <sup>2</sup>	
Material	housing: PC polycarbonate, black sealing: EPDM, 65 shore, black	
Installation	screw mounting	



## Types and variants

Types	DSM 9624 Pt / DSM 9624 W	DSM 4824 Pt / DSM 4824 W
Front panel (mm)	96 x 24	48 x 24
Housing (mm)	91,7 x 21,7	44,4 x 21,6
Cut-out (mm)	92 x 22,2	45 x 22,2
Installation depth (mm)	74	54
Weight (kg)	0,15	0,1
Types DSM 9624 Pt DSM 4824 Pt	Measuring range	Display
Temperature measurement Pt 100	-200 °C to +850 °C	-19999 to 99999
Types DSM 9624 W DSM 4824 W	Measuring range	Display
Resistance measurement	2-wire	
	0-1 kΩ	-1999 to 9999
	0-10 kΩ	-1999 to 9999
	0-100 kΩ	-1999 to 9999
Resistance measurement	3-wire	
	>1 kΩ to <1000 kΩ	-1999 to 9999
Type DSM 9624 Pt	auxiliary voltage 230 VAC/24 VDC	
Type DSM 9624 W	auxiliary voltage 230 VAC/24 VDC	
Type DSM 4824 Pt	auxiliary voltage 24 VDC	
Type DSM 4824 W	auxiliary voltage 24 VDC	

Measuring transducers  
1  
Mains and limit monitoring  
2  
Energy meters  
3  
Panel meters digital  
4



## Connection

DSM 9624 Pt

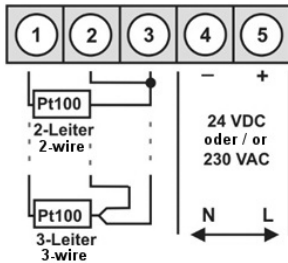

DSM 4824 Pt

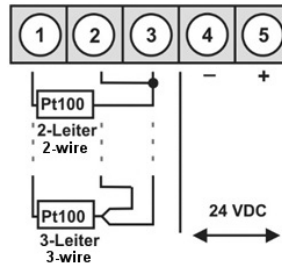

DSM 9624 W

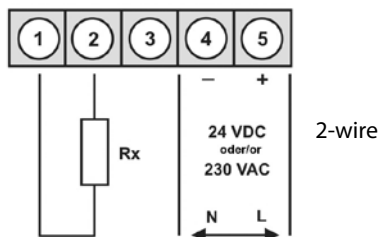

DSM 4824 W

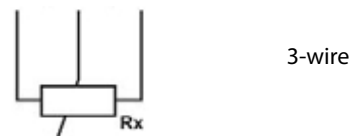
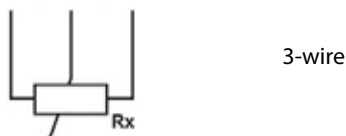
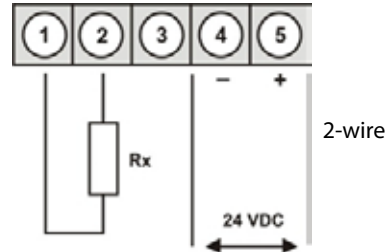

(In case of order please specify 2-wire or 3-wire!)

(In case of order please specify 2-wire or 3-wire!)

Panel meters analog  
5  
Meas. instruments for top hat rail mounting  
6  
Universal measuring instruments  
7  
Current transformers  
8  
Shunts  
9



Also available in black.  
Please specify separately.

## Digital measuring instruments

4 digit, 96 x 48 mm  
with two adjustable limit values  
for direct and alternating current and voltage  
(True RMS)

Type:  
**DSMG 96**



### Application

The digital measuring instrument DSMG 96 may be used for measuring and monitoring two limit values with direct current and direct voltage, alternating current and alternating voltage as well as for the indication of transformed nonelectrical parameters.



### Function

The measurand is sent to a 4-digit A/D converter via series resistors and shunts (in case of alternating current via an rms rectifier). The conversion is made following the „Dual Slope“ principle. The values are indicated by 7-segment low-power LED displays. The measurand is continuously compared to the set limit values. As soon as the limit values are reached, the related limit value contacts are switched. The programming of the limit values is done via the front panel using membrane keys. The measuring instrument is equipped with a min/max value memory. The zero point compensation is done automatically. Decimal points, dark switching of the last digit, zero point as well as display range may be changed after removing the front panel.

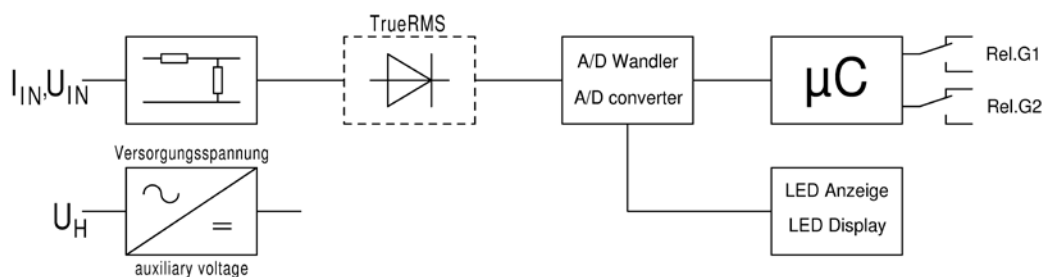

### Technical data

Display	LED seven-segment low-power, height 13mm, red; 4-digit
Decimal points	adjustable on front panel using DIP switch
Dark switching	of last digit, on front panel using DIP switch
Polarity	by negative (-) display
Overflow	flashing LED
Resolution	maximum display +/- 9999 digit
Sampling rate	approx. 3 measurements per second
Measurement principle	Dual-Slope integration
Accuracy	± 0,1 % of measured value ± 1 digit for direct voltage ± 0,2 % of measured value ± 2 digit for direct current ± 0,2 % of measured value ± 2 digit for alternating current variables of arbitrary waveform, rms value up to crest factor 4, DC, 40-1000 Hz
Temperature range	-15 °C to +20 °C to +30 °C to +55 °C
Temperature influence	< 0,05 % at 10 K
Overload capacity	voltage 10-fold, max. 850 V, current 10-fold up to 20 mA, above 2-fold
<b>Limit values</b>	
Switching accuracy	± 0 digit
Switching time	< 400 ms for 10 % limit value exceedance
Hysteresis	adjustable from 0-10 % off limit value
Switching delay	adjustable from 0-150 s
Relay contacts	2 changeover contacts
Switching capacity	max. 8 A, 250 V AC, 2000 VA
Test voltage	4 kV between measuring input and auxiliary voltage
IP code	housing IP 50, terminals IP 10
Connection	plug-in 12-pin terminal block, screw terminal max. 2,5 mm <sup>2</sup>
<b>Auxiliary voltage</b>	
Standard	230 V AC ± 20 %, 45-65 Hz, 3 VA
Options	24 V DC, -15 % to +25 %, 2,5 W 6-30 V AC + DC or 36-265 V AC + DC, 2,5 VA





## Types and variants

<b>Type</b>	DSMG 96 4-digit		
Front panel (mm)	96 x 48		
Housing (mm)	90 x 42,5		
Cut-out (mm)	92 x 45		
Installation depth (mm)	118		
Weight (kg)	0,35		
<b>Type of current</b>	<b>Measuring range</b>	<b>Display</b>	<b>Internal resistance</b>
Direct voltage DC	± 60 mV	1000 to 9999	> 100 M Ω
	± 100 mV	1000 to 9999	> 100 M Ω
	± 1 V	1000 to 9999	> 1 M Ω
	± 10 V	1000 to 9999	1 M Ω
	± 100 V	1000 to 9999	1 M Ω
	± 600 V	1000 to 9999	1 M Ω
Direct current DC	± 1 μA	1000 to 9999	100 k Ω
	± 10 μA	1000 to 9999	10 k Ω
	± 100 μA	1000 to 9999	1 k Ω
	± 1 mA	1000 to 9999	100 Ω
	± 10 mA	1000 to 9999	10 Ω
	± 20 mA	1000 to 9999	10 Ω
	4 - 20 mA	1000 to 9999	10 Ω
	± 100 mA	1000 to 9999	1 Ω
	± 1 A	1000 to 9999	0,1 Ω
	± 5 A	1000 to 9999	0,02 Ω
Direct and alternating voltage DC + AC True RMS	0 - 100 mV	1000 to 9999	> 100 M Ω
	0 - 1 V	1000 to 9999	100 k Ω
	0 - 10 V	1000 to 9999	1 M Ω
	0 - 100 V	1000 to 9999	1 M Ω
	0 - 600 V	1000 to 9999	1 M Ω
Direct and alternating current DC + AC True RMS	0 - 1 mA	1000 to 9999	100 Ω
	0 - 10 mA	1000 to 9999	10 Ω
	0 - 100 mA	1000 to 9999	1 Ω
	0 - 1 A	1000 to 9999	0,1 Ω
	0 - 5 A	1000 to 9999	0,02 Ω
<b>Surcharges</b>	Outside of standard series		
	Different measuring unit (e.g. mm/h)		
	Auxiliary voltage	24 V DC 6-30 V AC + DC 36-265 V AC + DC	



## Connection

**Front view**  
(without front panel)

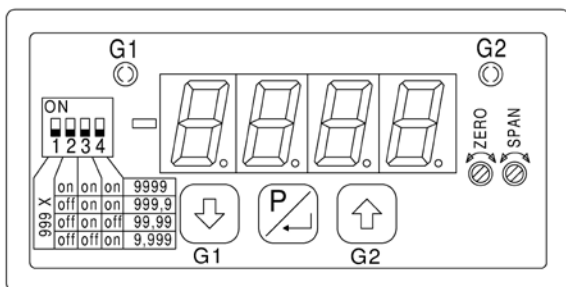

**Rear view**

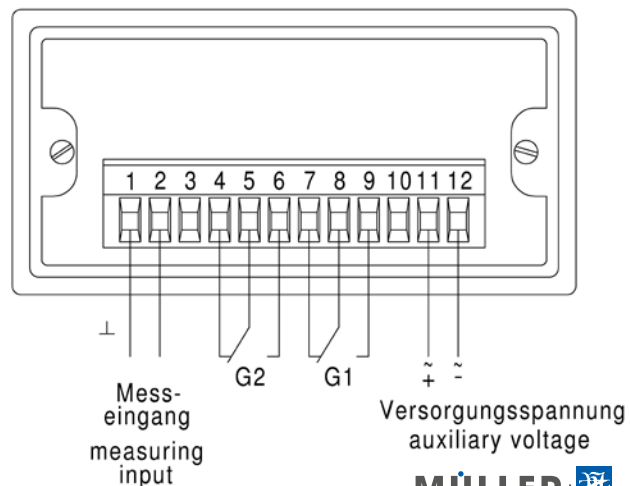

1 Measuring transducers

2 Mains and limit monitoring

3 Energy meters

4 Panel meters digital

5 Panel meters analog

6 Meas. instruments for top hat rail mounting

7 Universal measuring instruments

8 Current transformers

9 Shunts

10 Test apparatus



Also available in black.  
Please specify separately.

## Digital measuring instruments

4 digit, 96 x 48 mm  
with two adjustable limit values  
for temperature and resistance

Type:  
**DSMG 96 Pt, DSMG 96 W**

### Application

The digital measuring instrument DSMG 96 Pt may be used for measuring and monitoring two limit values during temperature measurements in connection with a resistance thermometer Pt 100. Type DSM 96 W is designed for measuring resistances.

### Function

The measurand is converted into a direct voltage in an evaluation circuit and fed to a 4-digit A/D converter. The conversion is made following the „Dual Slope“ principle. The values are indicated by 7-segment low-power LED displays. In case of line breakage of the Pt 100, the LED flashes. The measurement may be done in two-wire or three-wire technique. The measurand is continuously compared to the set limit values. As soon as the limit values are reached, the related limit value contacts are switched. The programming of the limit values is done via the front panel using membrane keys. The measuring instrument is equipped with a min/max value memory. The zero point compensation is done automatically. Decimal points, dark switching of the last digit, zero point as well as display range may be changed after removing the front panel.

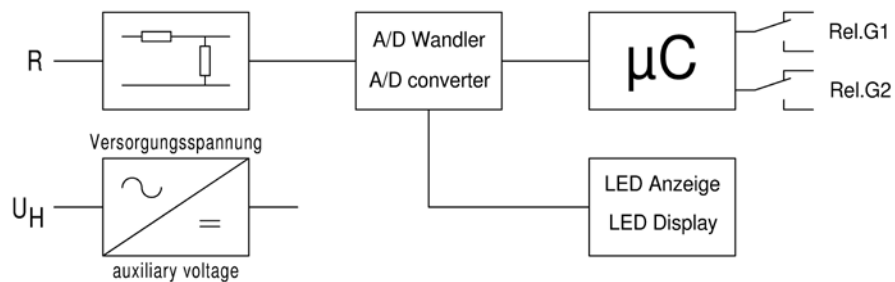

### Technical data

Display	LED seven-segment low-power, height 13mm, red; 4-digit
Decimal points	adjustable on front panel using DIP switch
Dark switching	of last digit, on front panel using DIP switch
Sensor current	max. 3 mA
Sensor voltage	max. 4 V
Two-wire technique	max. input lead resistance 10 Ω (adjustment using „ZERO“ potentiom.)
Three-wire technique	max. 100 Ω input lead resistance symmetrical
Polarity	by negative (-) display
Overflow	flashing LED
Resolution	maximum display +/- 9999 digit
Sampling rate	approx. 3 measurements per second
Measurement principle	Dual-Slope integration
Accuracy	± 0,2 %, ± 2 digit of measuring range
Temperature range	-15 °C to +20 °C to +30 °C to +55 °C
Temperature influence	< 0,05 % at 10 K
Test voltage	4 kV between measuring input and auxiliary voltage
<b>Limit values</b>	
Switching accuracy	± 0 digit
Switching time	< 400 ms for 10 % limit value exceedance
Hysteresis	adjustable from 0-10 % off limit value
Switching delay	adjustable from 0-150 s
Relay contacts	2 changeover contacts
Switching capacity	max. 8 A, 250 V AC, 2000 VA
Test voltage	4 kV between measuring input and auxiliary voltage
IP code	housing IP 50, terminals IP 10
Connection	plug-in 12-pin terminal block, screw terminal max. 2,5 mm <sup>2</sup>

<b>Auxiliary voltage</b>	Standard	230 V AC ± 20 %, 45-65 Hz, 3 VA
	Options	24 V DC, -15 % at +25 %, 2,5 W
		6-30 V AC + DC or 36-265 V AC + DC, 2,5 VA



## Types and variants

<b>Type</b>	DSMG 96 Pt / W	
Front panel (mm)	96 x 48	
Housing (mm)	90 x 42,5	
Cut-out (mm)	92 x 45	
Installation depth (mm)	118	
Weight (kg)	0,35	

<b>DSMG 96 Pt 4-digit</b>	Measuring range	Display
Temperature measurement Pt 100	-60 to +850 °C	-60,0 to +850,0 °C

<b>DSMG 96 W4-digit</b>	Measuring range	Display
Resistance measurement	3-wire circuit	an arbitrary value between 0-100 Ω to 0-10 kΩ      1000 to 9999
	2-wire circuit	0-100 Ω      1000 to 9999 0-1 k Ω      1000 to 9999 0-10 k Ω      1000 to 9999

<b>Surcharges</b>	Outside of standard series	
	Different measuring unit (e.g. mm/h)	
	Auxiliary voltage	24 V DC 6-30 V AC + DC 36-265 V AC + DC

In case of resistance measurement: Please specify 2-wire or 3-wire circuit in order!



## Connection

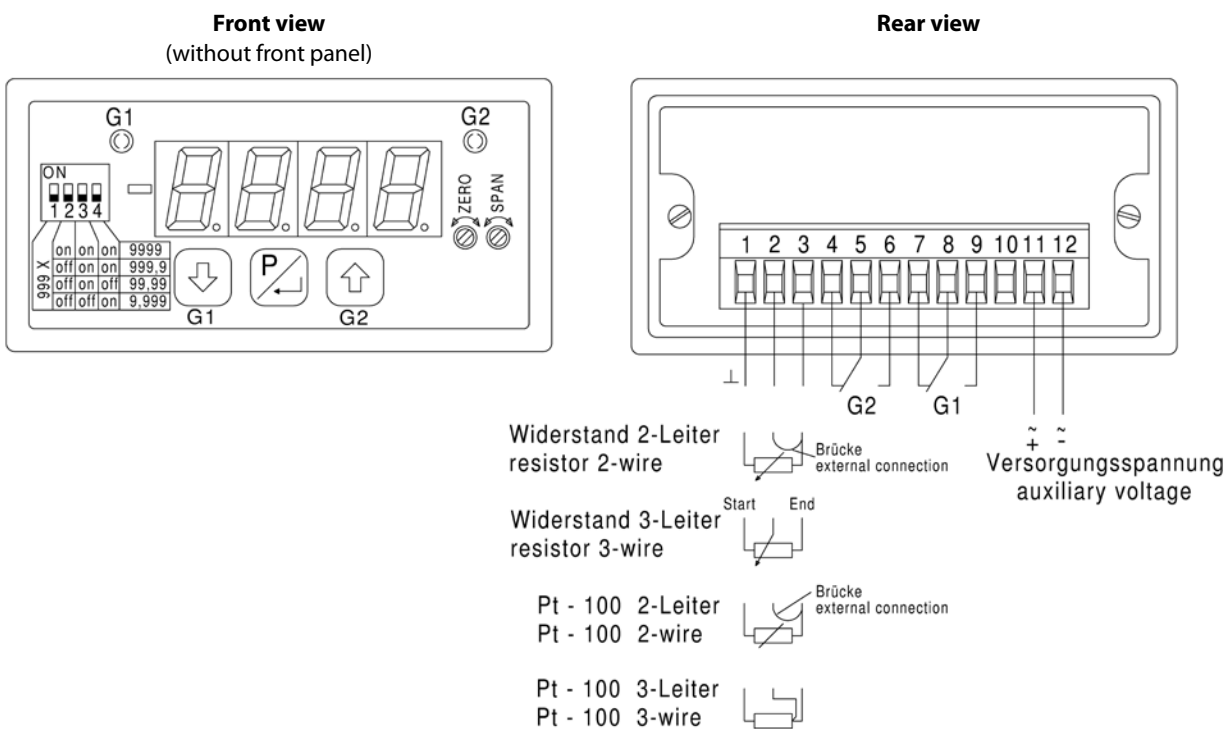



# Precision and service are the measure of all things

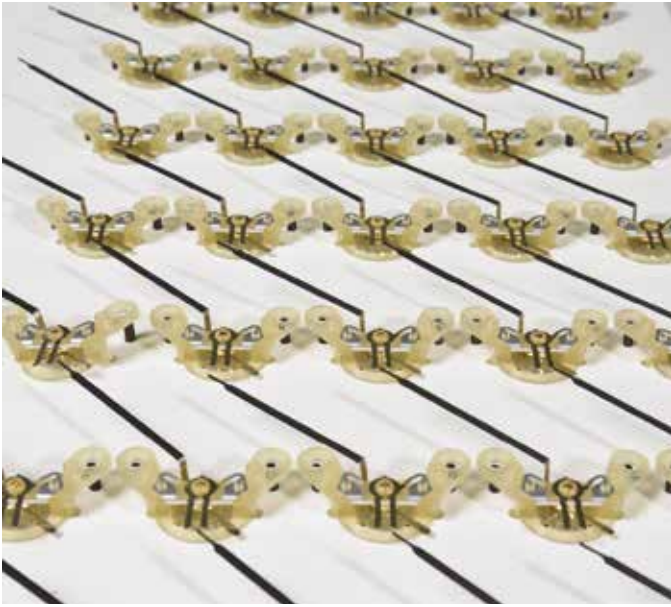

Measuring transducers

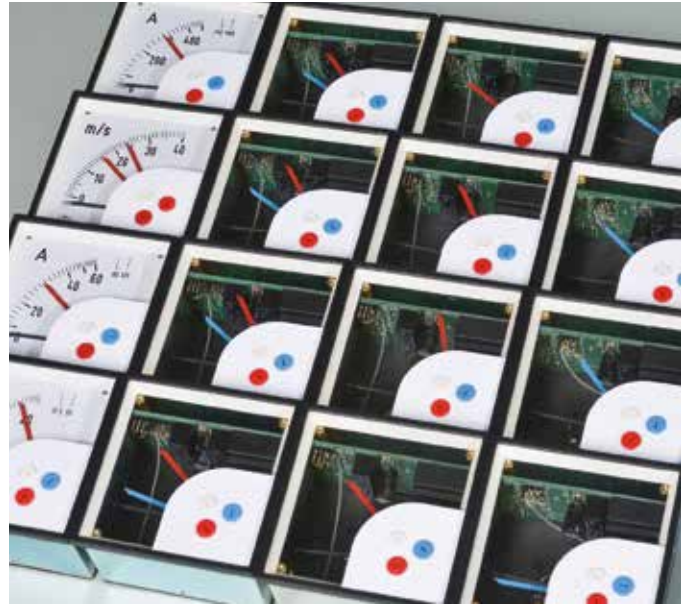

Mains and limit monitoring

Energy meters

Panel meters digital

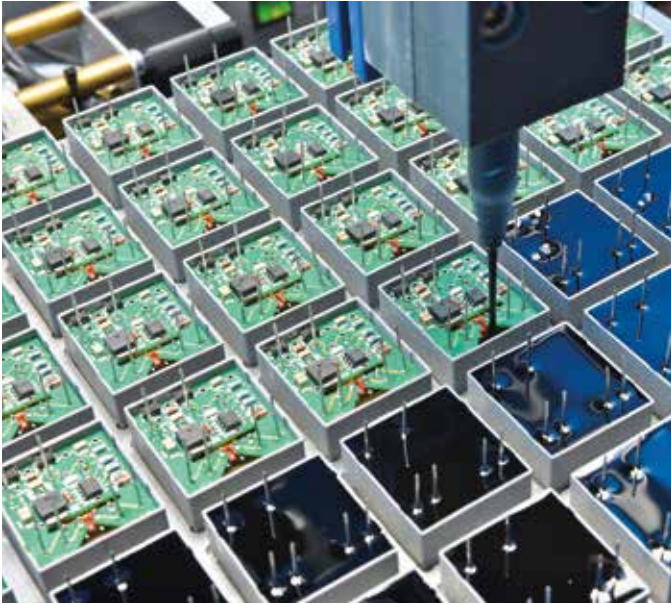

Panel meters analog

Meas. instruments for top hat rail mounting



Universal measuring instruments



Current transformers



Shunts



**MÜLLER  
ZIEGLER**  
Elektrische  
Messgeräte  
Gunzenhausen

**LÜBERG**  
TECHNOLOGIE-HOLDING

Nürnberg

## MÜLLER + ZIEGLER GmbH

Elektrische Messgeräte  
Industriestraße 23  
91710 Gunzenhausen, Germany  
Phone: +49 9831 5004-0  
Mo - Thu 7 - 12 / 13 - 16 H  
and Fr 7 - 12 H  
Fax: +49 9831 5004-20  
info@mueller-ziegler.de  
www.mueller-ziegler.de

A member company of:

**LÜBERG**  
Technologieholding GmbH  
Marienstr. 20, 90402 Nürnberg  
www.lueberg-technologie.de



made in germany

