

■ SINGLE PHASE POWER ANALYSER

# C.A 8220





Meaning of symbol. Warning! Read these operating instructions carefully before using the appliance. If the instructions preceded by this symbol are not followed in this operating manual, an accident to persons or damage to the appliance and the installations may result.

---



Compliant with directive WEEE 2002/96/EC.

---

You have just purchased a C.A 8220 single phase power detector and we would like to thank you for your confidence.

To get the best service from your appliance:

- Read these operating instructions carefully,
- Follow the precautions before use.

## PRECAUTIONS FOR USE

---















- Respect the climatic conditions for use (see paragraph 8.4.1, on page 32).
- This appliance can be used on category III installations, for voltages not exceeding 600 V RMS to earth (in accordance with CEI 664-1 Ed. 92).
- CAT III: the measurement category III corresponds to the measurements taken in the building installation. Example: measurements of electrical panels, cabling, etc.
- This appliance can be used on category IV installations, for voltages not exceeding 300 V RMS to earth (in accordance with CEI 664-1 Ed. 92).
- CAT IV: the measurement category IV corresponds to measurements carried out at the source of the low voltage installation. Example: metering and measurements on the overload protection devices.
- Only use measurement and voltage category accessories that are earthed at least equally to the product itself.
- When removing the battery, please ensure that the measurement and sensor cables are unplugged.

## GUARANTEE

---

Our guarantee, except with express stipulation, is valid for twelve months after the date the material is provided (extract from our General Terms and Conditions of Sale, sent on request).

# CONTENTS

<b>1. Introduction</b>	<b>4</b>
<b>2. Colisage</b>	<b>4</b>
<b>3. Présentation</b>	<b>5</b>
3.1 Vue générale	5
3.2 Les bornes électriques	5
3.3 L'écran de visualisation	5
3.4 Les touches	7
3.5 Le commutateur rotatif	7
3.6 Le témoin lumineux	7
3.7 L'interface optique	7
3.8 La béquille	7
3.9 L'alimentation	7
3.10 Résumé des fonctions	8
<b>4. Commutateur rotatif et modes</b>	<b>9</b>
4.1 Vue générale du commutateur	9
4.2 Note sur le choix d'un mode	9
4.3 Position OFF	9
4.4 Position 	10
4.5 Position 	12
4.6 Position 	13
4.7 Position 	14
4.8 Position 	17
4.9 Position 	17
4.10 Position  (mode configuration) ... <b>Erreur ! Signet non défini.</b>	
<b>5. Les touches (outils)</b> Erreur ! Signet non défini.	
5.1 Touche 	21
5.2 Touche 	21
5.3 Touche 	22
5.4 Touche 	23
5.5 Touches  	24
5.6 Touche <i>blanche</i> 	24
5.7 Touche <i>jaune</i> 	24
<b>6. Utilisation</b>	<b>25</b>
6.1 Mise en marche	25

6.2 Mise en place des cordons	26
6.3 Extinction automatique	27
6.4 Mesure des tensions	27
6.5 Mesure des courants	27
6.6 Mesure des puissances	27
6.7 Mesure des harmoniques	27
6.8 Mesure <i>Inrush</i>	27
6.9 Détermination de la rotation des phases	28
6.10 Mesure de la vitesse de rotation	28
6.11 Mesure de la température	28
6.12 Mesure de résistance	28
6.13 Photographie de mesures	28
6.14 Arrêt de l'appareil	28
6.15 Affichage d'informations	28
6.16 Alimentation du C.A 8220	28

<b>7. Maintenance</b>	<b>29</b>
7.1 Recommandation importante	29
7.2 Batterie	29
7.3 Nettoyage du boîtier	29
7.4 Vérification métrologique	29
7.5 Réparation	29
7.6 Mise à jour du logiciel embarqué	29
7.7 Capteurs	30

<b>8. Caractéristiques générales</b>	<b>31</b>
8.1 Boîtier	31
8.2 Alimentations	31
8.3 Conformité	32
8.4 Conditions d'environnement	32

<b>9. Caractéristiques fonctionnelles</b>	<b>33</b>
9.1 Conditions de référence	33
9.2 Caractéristiques électriques	33

<b>10. Annexes</b>	<b>37</b>
10.1 Formules mathématiques	37
10.2 Diagramme des 4 quadrants	38
10.3 Saturation des voies d'entrée	38

<b>11. Pour commander</b>	<b>39</b>
11.1 Power Quality Analyser C.A 8220	39
11.2 Accessoires	39
11.3 Rechanges	39

# 1. INTRODUCTION

The C.A 8220 is an AC+DC 600 V category III single phase power analyser (IEC 1010) with a digital LCD display screen. It is a measurement tool for effective values, power and electricity distribution network disturbances, enabling the user to obtain instant images of the main characteristics of a single phase network (voltage, current, powers, voltage/current harmonics, etc.) and to monitor machines in operation (temperature, current and duration of launch, resistance of windings, rotation speed). Compact and shock resistant, its ergonomic design and easy interface make it user friendly and intuitive.

The C.A 8220's accuracy is better than 1% (not including error due to current sensors). It has a greater flexibility due to its choice of different sensors for measuring from a few hundred milliamperes (MN93A) to several kiloamperes (Amp**FLEX**).

The C.A 8220 is designed for technicians, company control and maintenance team engineers, as well as administrations subscribed to yellow rates (36,kVA to 250,kVA) and green rates (> 250 kW).

The characteristics of the appliance are detailed on page 34.

# 2. PACKAGE

## Basic equipment

Description	Qty
Set of 2 banana-banana security cables (red / black) (IEC 1010).	1
Set of 2 crocodile clamps (red/ black).	1
Set of 2 test leads (red / black).	1
An MN93A clamp ('black') or an Amp <b>FLEX</b> A193 450 mm sensor ('black') or without current sensor.	-
AA format non-rechargeable battery (IEC LR6 or NEDA 15A).	6
Optical RS232 cable with RS232-USB adapter.	1
Operating instructions on CD-ROM and various documents.	1

## Optional equipment

Description
Transportation pouch.
Power supply unit (600 V <sub>RMS</sub> cat. III)
MN93, MN93A, C193, PAC93 clamps
Amp <b>FLEX</b> A193 800 mm and 450 mm sensor.
Six rechargeable cells (on external charger available as an option) in AA format (LR6 - NEDA 15A) with minimal capacity of 1800 mAh.
Data processing software.
5 A adapter unit (three phase) (for simultaneous connection of 3 C.A 8220's).
Thermic Seiko DPU 414 printer, delivered with optical cable.

# 3. PRESENTATION

## 3.1 Overview

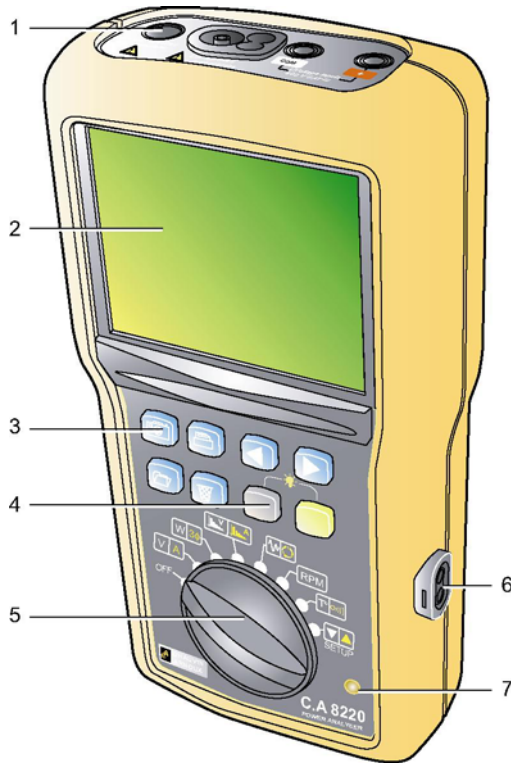

Figure 1: Overview of C.A 8220.

Rep.	Function	See §
1.	Electrical terminals.	3.2
2.	LCD screen with backlighting.	3.3
3.	Blue keys.	3.4
4.	White/yellow keys.	3.4
5.	Rotary switch.	3.5
6.	Infrared optical interface.	3.7
7.	External power light indicator.	3.6

## 3.2 Electrical terminals

Located on the top of the appliance, these terminals are used as follows:

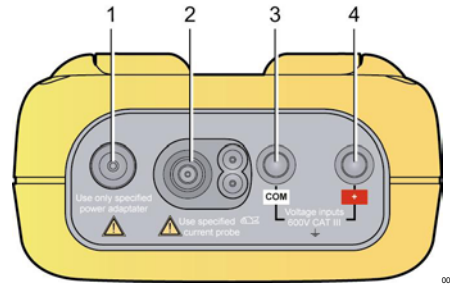

Figure 2: The terminals on the top of the appliance.

Rep.	Function
1.	External power supply via dedicated power unit (option).
2.	4 point entry for amperemetric sensor (MN clamp, C clamp, AmpFLEX, etc.) (the type of current sensor is automatically detected and updated every second).
3.	Security adaptor for voltage measurement cable (negative terminal).
4.	Security adaptor for voltage measurement cable (positive terminal).

## 3.3 Visualisation screen

### 3.3.1 Presentation

This monochrome backlit liquid crystal display (LCD), has 172 segments for visualising measurements, saved data or settings menus. The detailed information relating to the measures visualised on this screen are the subject of chapter 4 on page 9. The following figure visualises all the displayable segments.

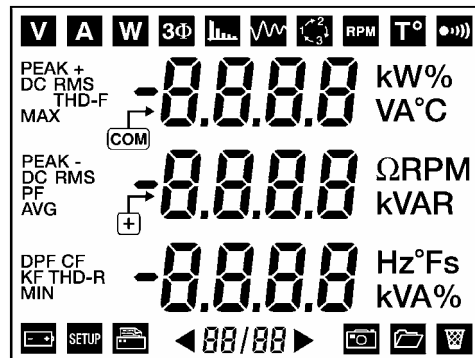























Figure 3: The displayable segments.

### 3.3.2 Backlighting

- Activate by simultaneously pressing the yellow () and white () keys.
- Switch off :
  - By simultaneously pressing the yellow () and white () keys again;
  - Or by switching the rotary switch to the **OFF** position.



### 3.3.3 Icons

The display uses the following icons:

Icon	Meaning	Page
	Measurements relating to voltage.	10
	Measurements relating to electrical current.	11
	Power measurement (active, reactive, apparent).	12
	Calculations associated with connection to a balanced activated three phase network.	12
	Measurement of voltage or current harmonics.	13
	Measurement of motor starting ( <i>inrush</i> ).	14
	Detection of order of phase rotation.	15
	Measurement of rotation speed.	17
	Measurement of temperature.	17
	Measurement of resistance (up to 2000 Ω).	17
	Battery low.	8
	Configuration of C.A 8220.	18
	Flashes during data transfer of information to the thermic serial printer.	23
	Number of active pages compared with total number of pages in the multiple pages modes.	
	Flashes while measurements are being photographed.	21
	Consultation of list of photographs, visualisation of a photograph.	21
	Deletion of one or all the photographs. Re-initialisation of effective values during half-period of voltage or current.	22











### 3.3.4 Abbreviations



The display uses the following abbreviations:

Unit	Meaning
%	Percentage.
Ω	Resistance in ohms.
°C	Temperature in degrees Celsius.
°F	Temperature in degrees Fahrenheit.
A	Intensity in amperes.
AVG	Real RMS value of the signal calculated over one second.
CF	Crest Factor (current or voltage).
DC	Continuous current and voltage component.
DPF	Displacement Factor (cosine of Φ).
Hz	Network frequency in hertz.
k	Kilo (10 <sup>3</sup> ).
KF	K Factor (for transformers).
MAX	Maximum RMS half-cycle voltage or current value.
MIN	Minimum RMS half-cycle voltage or current value.
PEAK	Instantaneous maximum (+) or minimum (-) crest value of signal measured.
PF	Power Factor (ratio of active power on the apparent power).
RMS	Real effective value (voltage or current).
RPM	Rotation speed in revolutions per minute (rotation per minute).
s	Duration in seconds.
THD-F	Total Harmonic Distortion (or THD).
THD-R	Distortion Factor (or DF).
V	Voltage in volts.
VA	Apparent Power (total if  )
VAR	Reactive Power (total if  )
W	Active Power (total if  )

### 3.4 Keys

Each key corresponds to one or more tools:

Rep.	Tool	Page
	Photographs measurements, viewable by pressing the  key.	21
	Prints all measurements currently displayed on a thermic serial printer.	23
	Selects the previous page, returns to previous step or (if only one page) selects the value.	24
	Selects the following page, advances to the next step or (if only one page) selects the value.	24
	Views screen photographs memorised by the  key.	21
	Deletion of one or all the screen photographs memorised or re-initialisation of the effective maximum and minimum half-cycle values.	22
	(White key) Access to voltage, power, voltage harmonic, motor start current, rotation speed and temperature modes.	24
	Reduction of the value in <i>Configuration</i> mode.	24
	Access to the <i>Information</i> mode.	24
	(Yellow key) Access to the current, balanced three-phase, current harmonic, phase rotation and resistance modes.	24
	Reduction of the value in <i>Configuration</i> mode.	24
	Inhibition of automatic extinction.	27

  +  (White and yellow keys): activation or de-activation of the display backlight.

### 3.5 The rotary switch

Its eight possible positions select the operating mode of the C.A 8220 (voltage, current, power, etc.). Details of available modes are given in chapter 4 on page 9.

### 3.6 The light indicator

Located in the bottom right hand corner of the appliance, this light indicator (Figure 1, rep. 7) (LED orange) is:

- **Lit** when the C.A 8220 is running on the optional mains power.
- **Switched off** when the C.A 8220 is running on its internal battery.

### 3.7 The optical interface

This optical bidirectional connection (Figure 1, rep. 6) has three distinct functions:

- Transmits all information and measurements relating to the current mode from the C.A 8220 to a thermic serial printer.
- Transmits all measurement data via specialised software from the C.A 8220 to a PC,.
- Transfers any embedded software updates available on the Chauvin Arnoux website from a PC to the C.A 8220.

In the last two cases, the transfer rate is automatically determined by the C.A 8220, in compliance with the software used; the maximum speed reaching 115.2 kbps.

 Communication between the CA 8220 and the PC can be, in certain cases, much improved by using the USB connection rather than the PC's RS232 connection.

### 3.8 The support stand

A retractable support stand (Figure 4, rep. 4), fixed at the back of the C.A 8220, and maintains the appliance in a position 30° to horizontal.

### 3.9 Power

#### 3.9.1 Battery

The electrical power supply for the C.A 8220 is ensured via six elements (standard batteries or rechargeable batteries) (Figure 4, rep. 1) in AA format (LR6 - NEDA 15A). The battery life is detailed in paragraph 3.9.2.

The elements are accessible, from the back of the C.A 8220, by turning the lock a quarter turn (rep. 2) anti-clockwise using a coin (rep. 3).

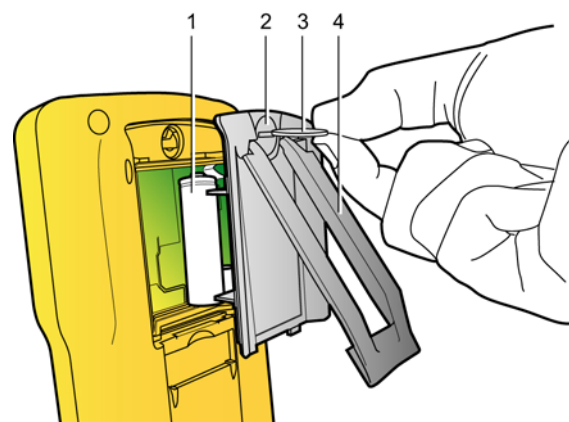

Figure 4: Accessing the battery elements.

### 3.9.2 Battery life

The table below details the battery life, in hours, depending on the type of battery.

Type of power supply	Back-lighting	
	Without	With
AA batteries	> 40 hours	> 20 hours
NiMH 1800, mAh accumulators	> 30 hours	> 16 hours
NiCd 900mAh accumulators	> 15 hours	> 8 hours

### 3.9.3 Operating on battery power

The battery life depends on the type of battery used (see paragraph 3.9.2). As soon as the pre-set battery voltage threshold is reached, one of the alert levels is activated:



- Level 1: the battery capacity is weak, but the appliance can still be used. The  icon, located in the bottom left of the screen, flashes once per second. At the same time, an audible beep is emitted once.
- Level 2: the battery power is low enough to require the immediate replacement of the batteries. The  icon, located in the bottom left of the screen, flashes once per second. In addition, every 10 seconds (and repeated 7 times for a whole minute) a beeping sound is emitted together with the **bAtT** message displayed on the screen. After once minute, the appliance switches itself off.



Figure 5: The low battery indicator signals the need for a replacement.

### 3.9.4 Mains operation

When the optional power unit is plugged in, the C.A 8220 uses mains power, without discharging on the internal battery. The orange light (Figure 1, rep. 7) is lit. Indeed, the battery does not need to be fitted when operating on mains power.

## 3.10 Summary of functions

### 3.10.1 Measurement functions

- Effective voltage value up to 600 V.
- Effective current value up to 6500 A.
- DC value for voltage and current.
- Effective minimum and maximum half-cycle voltage and current values.
- Crest values for voltage and current.
- 50 Hz, 60 Hz network frequencies (scope of measure: 40 Hz to 70 Hz).
- Crest factor for current and voltage.
- K factor (KF) of current (application of transformers).
- Distortion factor (DF or THD-R) of current and of voltage.
- Total harmonic distortion (THD or THD-F) for current and voltage.
- Active, reactive and apparent power.
- Power factor (PF) and displacement factor (DPF or  $\cos \phi$ ).
- Active, reactive and apparent powers (totals in balanced three-phase mode .
- Harmonics for current and voltage up to rank 50: RMS value, percentage compared with fundamental.
- Rotation speed.
- Temperature - temperature probe with 2 platinum 100 type wires (PT100). Simultaneous display in °C and °F.
- Resistance values with beep over 20  $\Omega$  (by default).

### 3.10.2 Advanced functions

- *Inrush* mode: display of parameters used for the study of a motor start.
  - Maximum absolute instantaneous current value (on whole start).
  - Maximum RMS half-cycle current value (on whole start).
  - Duration of motor start.
- Determination of order of phase rotation (2 wire method): display of phase order for a three-phase network.
- Photographs of data from voltage, current, power, three-phase balanced, harmonic voltage and harmonic current modes.
- Display of appliance information (serial number, embedded software version, material version).
- Automatic shut-off of appliance.

### 3.10.3 Configuration functions

- Choice of connection (standard single-phase or balanced three-phase).
- Threshold and hysteresis of motor starting current.
- Number of events per revolution and threshold for detection of events for the rotation speed mode.
- Selection of TI (or TC) ratio for the MN93A clamp (5 A calibre) and the 5A adapter.
- Automatic recognition of type of current sensor.



## 4. ROTARY SWITCH AND MODES

### 4.1 Overall view of switch

The modes available by turning the rotary switch to its 8 positions are listed below with links to the relevant pages.

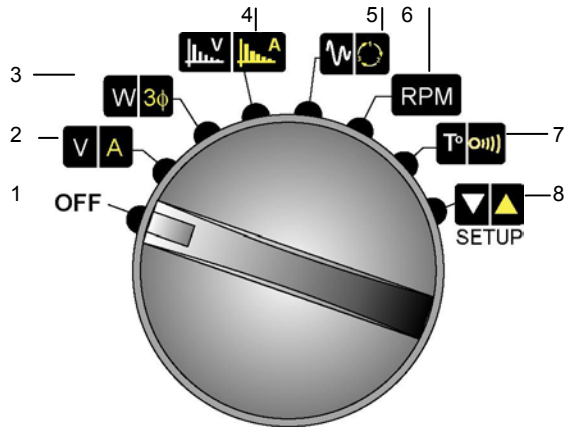

Figure 6: View of modes accessible from the rotary switch.



The paragraphs with a yellow background relate to the modes accessible after rotating the switch to the desired position and pressing the yellow key ( ).

Rep.	Position	Mode	Page
1	OFF	The appliance switched off.	9
2	V A	Voltage mode.	10
	+ (Yellow key)	Current mode.	11
3	W 3Φ	Power mode.	12
	+ (Yellow key)	Balanced three-phase mode (3Φ).	12
4	V A (with waveforms)	Harmonic voltage mode.	13
	+ (Yellow key)	Harmonic current mode.	14
5	(Waveform symbol)	Inrush mode (motor start).	14
	+ (Yellow key)	Phase rotation mode.	15
6	RPM	Rotation speed mode.	17
7	T° (with waveform)	Temperature mode.	17
	+ (Yellow key)	Resistance mode.	17
8	(White key) (Yellow key) SETUP	Configuration mode.	18

### 4.2 Note on selecting a mode



This note is valid for all the positions of the rotary switch with the exception of OFF, RPM and SETUP.

Any given position of the rotary switch corresponds to two measurement modes.

Example: in the V A position, the user can select either the voltage mode (V), or the current mode (A).

- The mode corresponding to the white symbol is activated when the rotary switch is positioned on a function.

Example: the voltage mode is activated when the switch is turned to the V A position.

- To access a mode corresponding to the yellow symbol, press the yellow key without changing the position of the rotary switch. This selection is indicated in the table opposite by boxes with a yellow background.

Example: the current mode is activated when the switch is in the V A position and after pressing the yellow key ( ).

To return to a mode with a white symbol, press the white key ( ).

### 4.3 OFF position

The C.A 8220 is switched off.

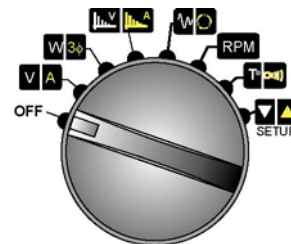

Figure 7: The rotary switch in the OFF position.

This position switches off the appliance.

## 4.4 Position **V A**

This position allows measurements relating to voltages or currents.

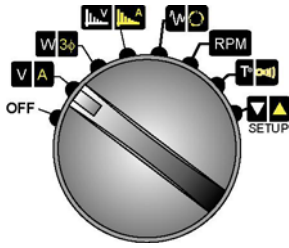



Figure 8: The rotary switch in **V A** position.

### 4.4.1 Voltage mode



The pages are displayed in rotation by using the   keys. There are 4 measurement pages in this mode.

#### 4.4.1.1 Page 1/4

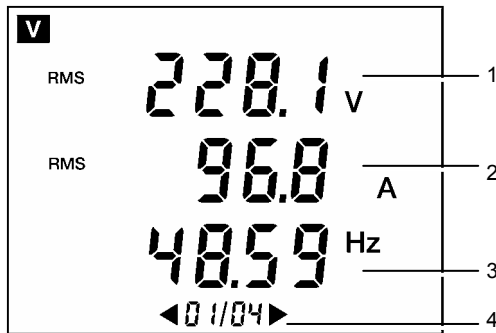

Figure 9: Example of display of page 1/4.

Rep.	Measurement
1.	Voltage root mean square value ( $V_{RMS}$ ).
2.	Current root mean square value ( $A_{RMS}$ ).
3.	Network frequency (Hz).
4.	Number of page displayed / total number of pages.



#### 4.4.1.2 Page 2/4

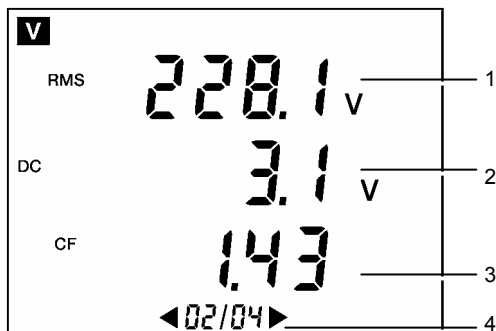

Figure 10: Example of display of page 2/4.

Rep.	Measurement
1.	Root mean square value ( $V_{RMS}$ ).
2.	Continuous voltage value (VDC).
3.	Voltage crest factor ( $V_{CF}$ ).
4.	Number of page displayed / total number of pages.



#### 4.4.1.3 Page 3/4

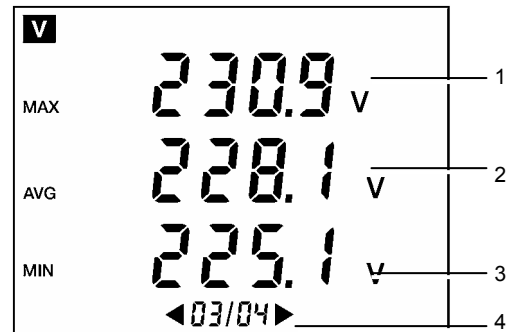



Figure 11: Example of display of page 3/4.

Rep.	Measurement
1.	Effective maximum voltage half-cycle value ( $V_{RMS1/2MAX}$ ) (see comment below).
2.	Root mean square value ( $V_{RMS}$ ).
3.	Effective maximum voltage half-cycle value ( $V_{RMS1/2MAX}$ ) (see comment below).
4.	Number of page displayed / total number of pages.



The effective maximum and minimum half-cycle values may be reinitialised by pressing the  key.

#### 4.4.1.4 Page 4/4

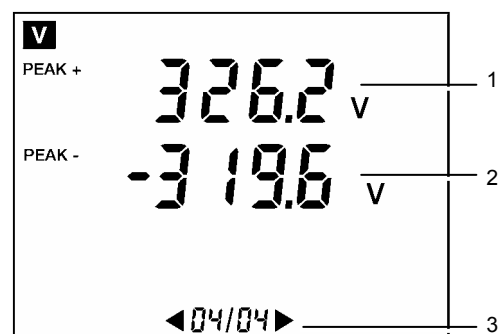

Figure 12: Example of display of page 4/4.

Rep.	Measurement
1.	Maximum voltage crest value ( $V_{PEAK+}$ ).
2.	Minimum voltage crest value ( $V_{PEAK-}$ ).
3.	Number of page displayed / total number of pages.

#### 4.4.2 Current mode



The pages are displayed in rotation by using the keys. There are 4 measurement pages in this mode.

##### 4.4.2.1 Page 1/4

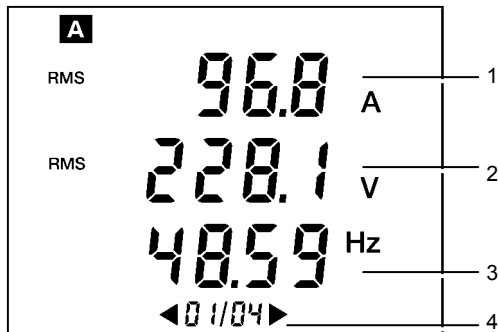

Figure 13: Example of display of page 1/4.

Rep.	Measurement
1.	Current root mean square value ( $A_{RMS}$ ).
2.	Voltage root mean square value ( $V_{RMS}$ ).
3.	Network frequency (Hz).
4.	Number of page displayed / total number of pages.

##### 4.4.2.2 Page 2/4

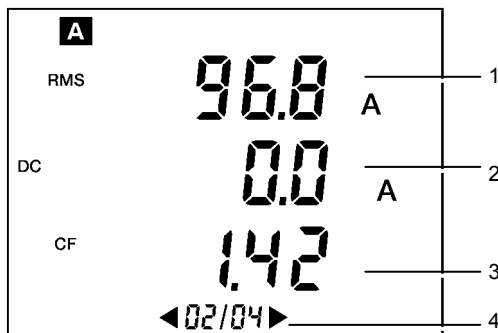

Figure 14: Example of display of page 2/4.

Rep.	Measurement
1.	Current root mean square value ( $A_{RMS}$ ).
2.	Continuous current value ( $A_{DC}$ ) for the <b>PAC</b> clamp only.
3.	Current crest factor ( $A_{CF}$ ).
4.	Number of page displayed / total number of pages.

##### 4.4.2.3 Page 3/4

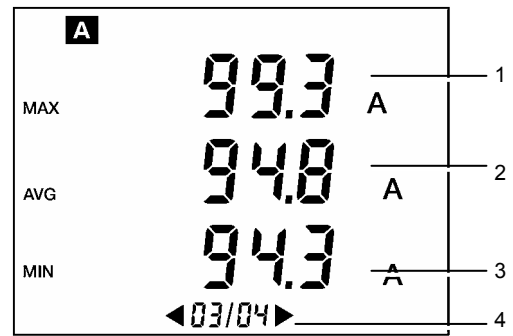

Figure 15: Example of display of page 3/4.

Rep.	Measurement
1.	Effective maximum current half-cycle value ( $A_{RMS1/2MAX}$ ) (see note below).
2.	Current root mean square value ( $A_{RMS}$ ).
3.	Effective minimal current half-cycle value ( $A_{RMS1/2MAX}$ ) (see note below).
4.	Number of page displayed / total number of pages.



The effective maximum and minimum half-cycle values may be reinitialised by pressing the key.

##### 4.4.2.4 Page 4/4

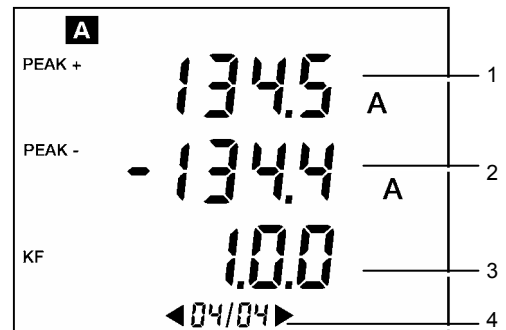

Figure 16: Example of display of page 4/4.

Rep.	Measurement
1.	Maximum current crest value ( $A_{PEAK+}$ ).
2.	Minimum current crest value ( $A_{PEAK-}$ ).
3.	Current K factor ( $A_{KF}$ ).
4.	Number of page displayed / total number of pages.

## 4.5 Position **W3Φ**

This measures the power (active, reactive, apparent, continuous), of the power and displacement factors (DPF or  $\cos\Phi$ ). The user can also define the activation or de-activation of the balanced three-phase mode (**3Φ**) depending on the type of connection.

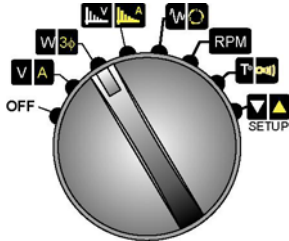

Figure 17: The rotary switch in **W3Φ** position.

### 4.5.1 Power mode



The pages are displayed in rotation by using the keys. There are 2 measurement pages in this mode.

#### 4.5.1.1 Page 1/2

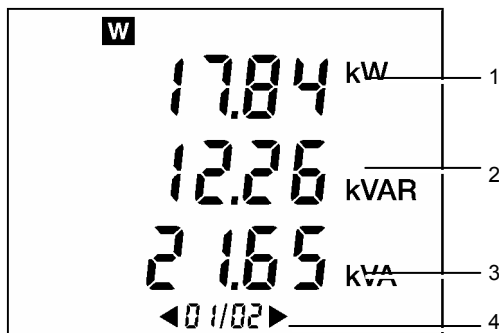

Figure 18: Example of display of page 1/2.

Rep.	Measurement
1.	Active power (W).
2.	Reactive power (VAR).
3.	Apparent power (VA).
4.	Number of page displayed / total number of pages.



The powers displayed are the total powers (sum of 3 phases) if the **3Φ** symbol is displayed.

#### 4.5.1.2 Page 2/2

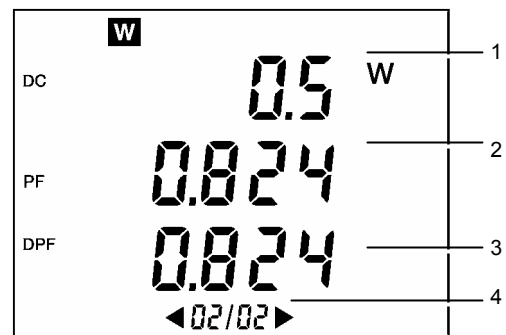

Figure 19: Example of display of page 2/2.

Rep.	Measurement
1.	Continuous power ( $W_{DC}$ ).
2.	Power factor (PF).
3.	Displacement factor (DPF, also noted as $\cos\Phi$ ).
4.	Number of page displayed / total number of pages.



The total continuous power ( $W_{DC}$ ) is not visualised if the **3Φ** symbol is displayed.

### 4.5.2 Selection of balanced three-phase calculations

When in view mode, the display indicates **OFF** or **On**.

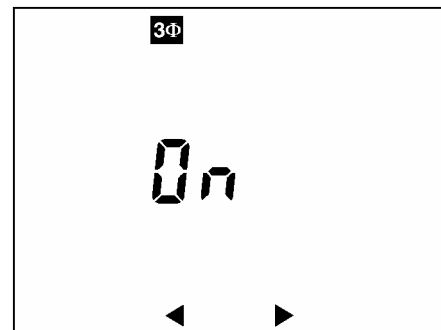

Figure 20: In this example, the calculations concerning the three-phase balanced network are activated.

With the message:

- **OFF**: the calculations (see § 10.1.9) associated with the connection of the appliance to a three-phase balanced network are de-activated. This choice is selected when measuring single-phase networks.
- **On**: the calculations (see §) associated with the connection of the appliance to a three-phase balanced network are activated. This choice is selected when measuring three-phase balanced networks.

The choice is made using the keys.

## 4.6 position

This measures the total harmonic distortion rate on voltage and current, as well as the effective value, the harmonic distortion factor, any continuous harmonic component and harmonics up to rank 50, over 51 or 52 pages.

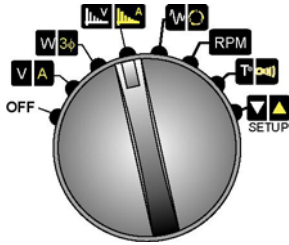



Figure 21: The rotary switch in  position.

### 4.6.1 Harmonic voltage mode



The pages are displayed in rotation by using the   keys. There are 52 measurement pages in this mode.

#### 4.6.1.1 Page 1/52

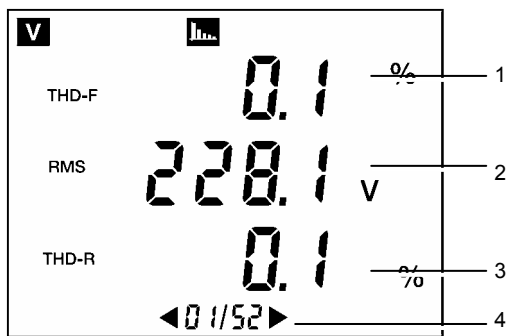

Figure 22: Example of display of page 1/52.

Rep.	Measurement
1.	Rate of total voltage harmonic distortion ( $V_{\text{THD-F}}$ - also noted as $V_{\text{THD}}$ ).
2.	Root mean square value ( $V_{\text{RMS}}$ ).
3.	Voltage distortion factor ( $V_{\text{THD-R}}$ - also noted as $V_{\text{DF}}$ ).
4.	Number of page displayed / total number of pages.



#### 4.6.1.2 Page 2/52

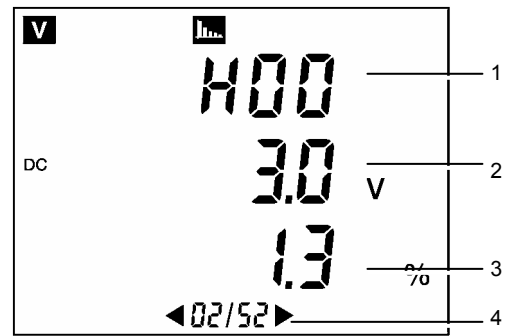

Figure 23: Example of display of page 2/52.

Rep.	Measurement
1.	Number of voltage harmonic considered (here ranked 00).
2.	The continuous harmonic component value.
3.	Percentage of the continuous value compared with the effective fundamental value.
4.	Number of page displayed / total number of pages.



#### 4.6.1.3 Page 5/52

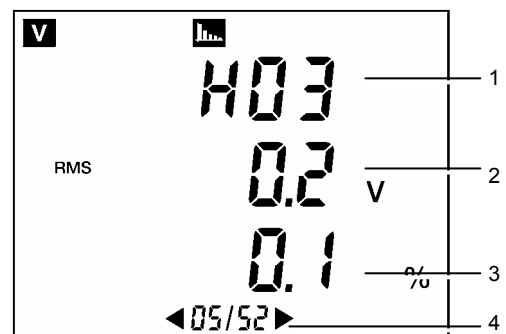

Figure 24: Example of display of page 5/52.

Rep.	Measurement
1.	Number of voltage harmonic considered (here ranked 03).
2.	Effective value of the harmonic component considered.
3.	Percentage of this effective value compared with the effective fundamental value.
4.	Number of page displayed / total number of pages.

#### 4.6.2 Current harmonic mode



The pages are displayed in rotation by using the keys. There are 52 measurement pages in this mode when a **PAC** clamp is connected and 51 measurement pages for all the other current sensors.

##### 4.6.2.1 Page 1/52

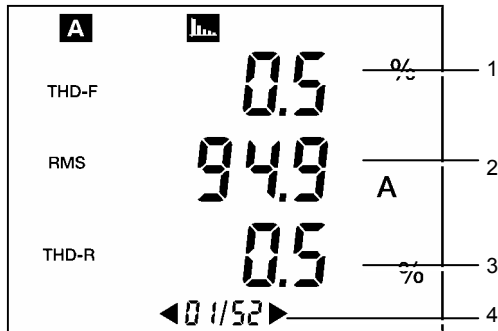

Figure 25: Example of display of page 1/52.

Rep.	Measurement
1.	Rate of total current harmonic distortion ( $A_{THD-F}$ – also noted as $A_{THD}$ ).
2.	Current root mean square value ( $A_{RMS}$ ).
3.	Current distortion factor ( $A_{THD-R}$ – also noted as $A_{DF}$ ).
4.	Number of page displayed / total number of pages.



##### 4.6.2.2 Page 2/52 (with PAC clamp)



When the current sensor is not a **PAC** clamp, refer to the next paragraph.

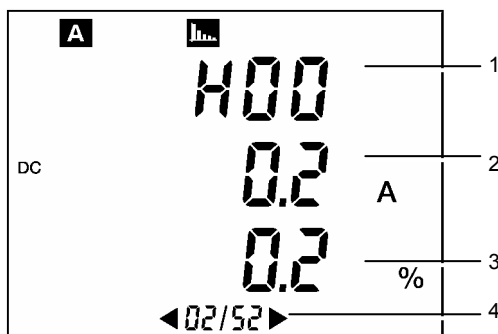

Figure 26: Example of display of page 2/52.

Rep.	Measurement
1.	Number of voltage harmonic considered (here ranked 00).
2.	Continuous harmonic component value.
3.	Percentage of the continuous value compared with the effective fundamental value.
4.	Number of page displayed/ total number of pages.



##### 4.6.2.3 Page 3/52 – with PAC clamp



This screen corresponds to screen 2/52 when the current sensor is not a **PAC** clamp.

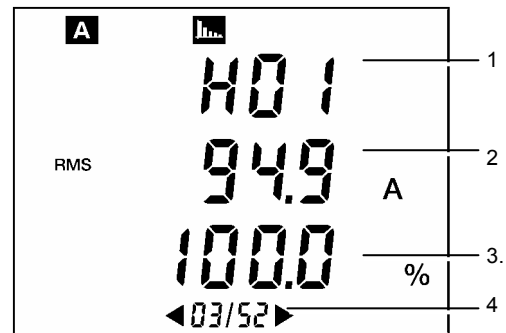

Figure 27: Example of display of page 3/52.

Rep.	Measurement
1.	Number of voltage harmonic considered (here ranked 01).
2.	Effective value of the harmonic component considered.
3.	Percentage of this effective value compared with the effective fundamental value. In this example, the fundamental is 100% of itself.
4.	Number of page displayed / total number of pages.



#### 4.7 position

This measures the values relative to a motor start (maximum half-cycle current effective value, maximum absolute instantaneous current value, duration of start) and determines the order of phase rotation.

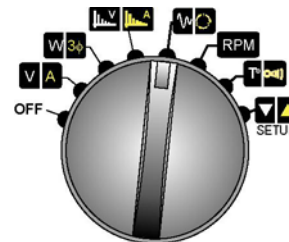

Figure 28: The rotary switch in position.

##### 4.7.1 Inrush mode (motor start)



This mode requires the C.A 8220 to be pre-configured. Refer to paragraphs 4.10.1 and 4.10.2 and on page 18. The cables (voltage and current) can be connected either in single-phase or balanced three-phase mode.

During steps 2, 3 and 4, it is possible to go back to the first step (step 1/4) by pressing the key.

#### 4.7.1.1 Step 1/4

As soon as the appliance is switched to this mode, the display indicates that the C.A. 8220 is ready. Pressing the  key accesses step 2/4.

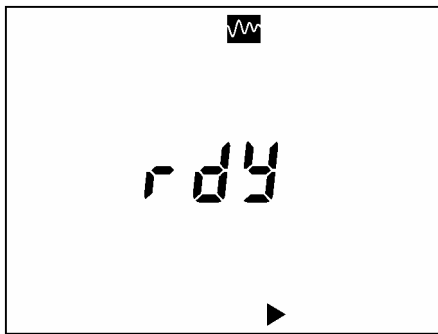

Figure 29: The C.A. 8220 is ready.



The *r dy* symbol means *ready*.

#### 4.7.1.2 Step 2/4

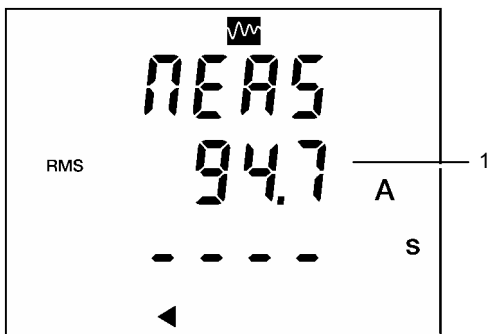

Figure 30: The C.A. 8220 waits until the starting current trigger threshold is exceeded.



The *NEAS* symbol means *measuring* (measurement in progress).

The motor to be monitored is thus switched on. The C.A. 8220 waits until the effective half-cycle current exceeds the current threshold for the parametered motor start (adjustment of this threshold in § 4.10.1, on page 18). The effective current calculated over a second is continuously displayed (rep.1). The appliance automatically moves to step 3/4.

#### 4.7.1.3 Step 3/4

As soon as the motor starting threshold is reached, the stopwatch is started (see Figure 31).

Once the motor to be monitored is running, the C.A. 8220 waits until the effective half-cycle current goes below the current set threshold (end of start threshold) (see adjustment in § 4.10.2, on page 18). The effective current calculated over a second is continuously displayed (rep. 1). The appliance automatically moves to step 4/4.

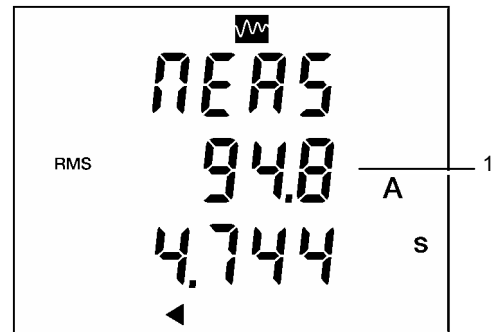

Figure 31: The stopwatch (bottom of the screen) is active until the low current threshold has been reached.

#### 4.7.1.4 Step 4/4

As soon as the end of motor starting threshold has been reached, the results are displayed.

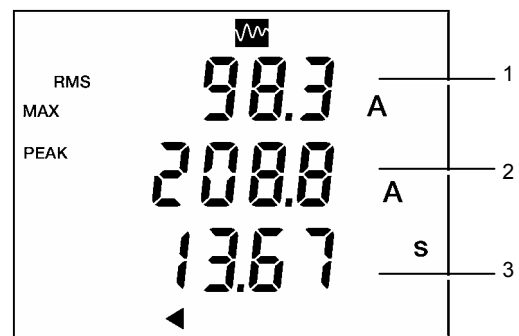

Figure 32: Example of results display.

The information is read as follows:

Rep.	Measurement
1.	Effective maximum half-cycle value of starting current.
2.	Absolute instantaneous value of starting current.
3.	Duration in seconds of motor starting.

#### 4.7.2 Phase rotation mode

The mode enables the user to determine the order of the phases of a three-phase network using the method known as "2 wire".



The activation of the balanced three-phase mode has no effect on determining the order of the phases (**3Φ** can be **U<sub>n</sub>** or **U<sub>FF</sub>**). The most important point is to respect the voltage connections as directed in 1 and 3.

#### 4.7.2.1 Step 1/4

As soon as the appliance is switched to this mode, the display indicates that the C.A. 8220 is ready (see following page).

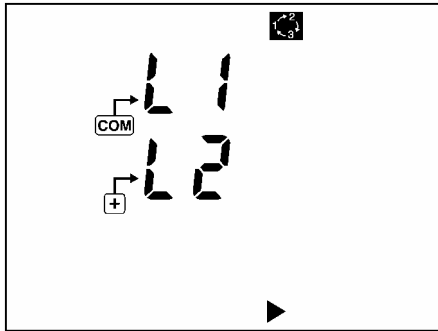



Figure 33: The C.A. 8220 is ready for the first measurement to determine the order of the phases.

Once the test leads are connected to the supposed L1 and L2 phases, pressing the  key moves the appliance to step 2/4.

#### 4.7.2.2 Step 2/4

The **NEAR5** message is displayed for a very short interval (see image below).

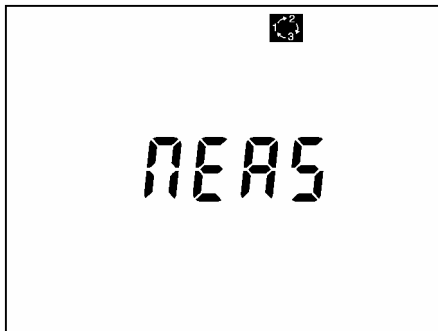

Figure 34: The C.A. 8220 displays this screen for a very short time.

One of the screens described in the next paragraph is then displayed.

#### 4.7.2.3 Step 3/4

Two cases are possible:

- The display indicates **Err** (Error): an error has been detected during the determination of the order of the phases. This error may be due to one of the following causes:
  - The three-phase network frequency is unstable.
  - The three-phase network frequency is outside the 40 Hz to 70 Hz range.
  - The voltage signal is too weak (below 10 V<sub>RMS</sub>).
  - Operations were incorrectly carried out.



It is then possible to come back to the first step (step1/4) by pressing the  key.

- The display screen shows the following screen.

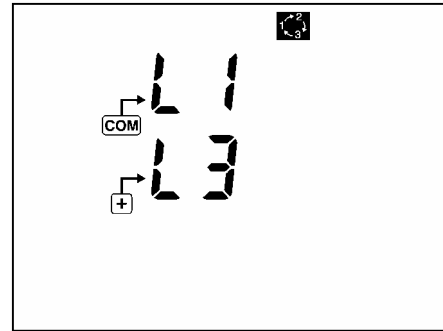

Figure 35: The C.A. 8220 is ready for the second measurement to determine the order of the phases.

The user should then connect the L3 phase to the input (+) of the appliance, within 10 seconds, after which time the following error message **ti NE OUT** (time limit exceeded) is displayed inviting the user to start the sequence again from the beginning (step 1/4).

As soon as the test leads are connected to the circuit, the C.A 8220 automatically moves to step 4/4.

#### 4.7.2.4 Step 4/4

Three cases are possible:

- **Case n° 1:** a direct order of phases has been determined. The following screen is displayed:

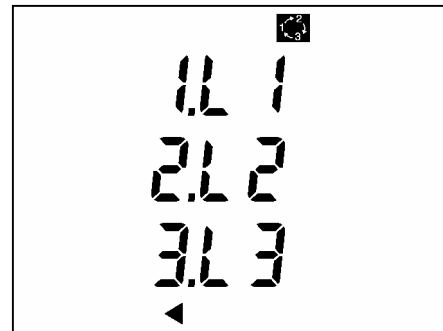

Figure 36: Direct order of phases.

- **Case n° 2:** an indirect order of phases has been determined. The following screen is displayed:

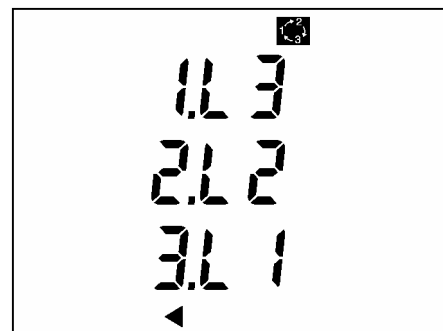



Figure 37: Indirect order of phases.



- **Case n° 3: Err** indicates that an error has occurred during the determination of the order of phases. This error may be due to one of the following causes:
  - Unstable three-phase network frequency.
  - Three-phase network frequency is outside the 40 Hz to 70 Hz range.
  - The voltage signal is too weak (below 10 V<sub>RMS</sub>).
  - Operations were incorrectly carried out.



It is then possible to come back to the first step (step1/4) by pressing the  key.

#### 4.8 RPM position (rotation speed mode)



This mode requires the C.A 8220 to be pre-configured. Refer to paragraphs 4.10.5 and 4.10.6 and on page 19.

In this position, the C.A 8220 measures the rotation speed of a turning element.



The tachometer signal should be inputted into the voltage (+) and (COM) terminals of the C.A 8220. The appliance thus measures the interval of time between each signal pulse (event) and subtracts the rotation speed in revolutions per minute.

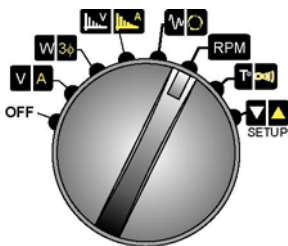

Figure 38: The rotary switch in RPM position.



Figure 39: Example of a rotation speed measurement.

#### 4.9 T° position

In this position, the C.A 8220 measures the temperature (using an external probe not provided) or the resistance of an electrical circuit.

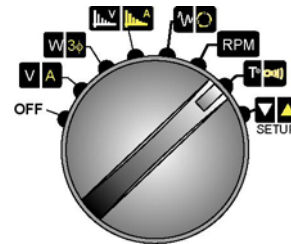

Figure 40: The rotary switch in T° position.

##### 4.9.1 Temperature mode

The C.A 8220 displays the temperature measured using a 100 platinum probe (not provided), connected to the (+) and (COM) terminals of the C.A 8220. The measurement is displayed simultaneously in degrees Celsius (°C) and degrees Fahrenheit (°F).

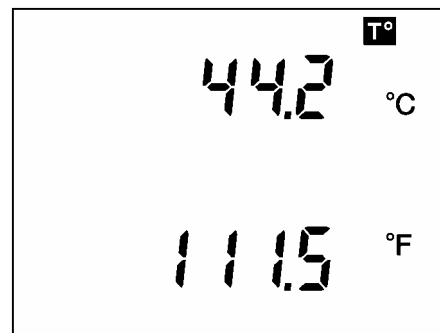

Figure 41: Example of a temperature measurement.

##### 4.9.2 Resistance mode

Two automatic calibrations are available:

- 0 Ω to 400 Ω: above 20 Ω (by default) a beeping sound is emitted.
- 400 Ω to 2000 Ω.

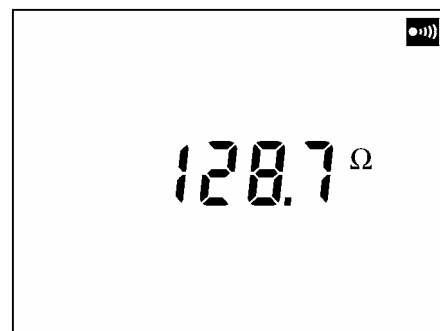

Figure 42: Example of a resistance measurement.

## 4.10 position (configuration mode)

This position is designed for configuring the parameters used by the C.A 8220. Once the configuration has been saved in the non-volatile memory, it can be accessed even after the appliance is shut down including during a battery change.

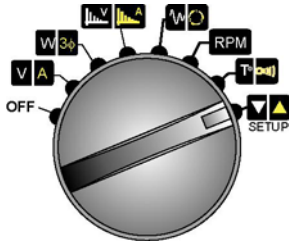



Figure 43: The rotary switch in  position

### 4.10.1 *St*rt parameter



The *St*rt symbol means *start*.

This parameter is used to configure the *Inrush*  mode.

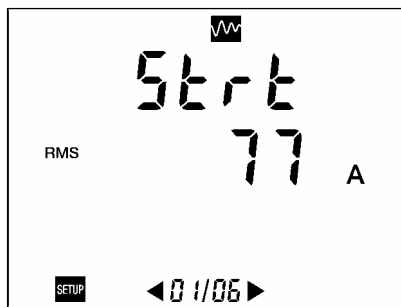



Figure 44: Display of parameter relating to the initial current.

The *St*rt parameter sets the effective half-cycle current value serving as the motor start threshold. When the motor starting current reaches or exceeds this threshold, the C.A 8220 will count the time during which the effective half-cycle current value is strictly in excess of the effective half-cycle end value (see Figure 31, on page 15).

The value is set using the white and yellow ( ) keys. The minimum and maximum terminals are 0 and 5,999 A.

### 4.10.2 *Hyst* parameter



The *Hyst* symbol means *hysteresis*.



This parameter is used to configure the *Inrush*  mode.



Figure 45: Display of parameter relating to hysteresis.

The *Hyst* parameter sets the effective half-cycle current value serving as the end of motor start threshold. As soon as the motor starting current is over or equal to the effective half-cycle current end (stop) value, the C.A 8220 will stop counting the starting time (see Figure 32, on page 15).

The value is set using the white and yellow ( ) keys. The preset values are 0, 1, 2, 5 and 10 %.



The effective half-cycle stopping value is calculated using the following formula.

$$[\text{effective half-cycle stopping value}] = [\text{effective half-cycle starting value}] \times (100 - [\text{hysteresis}]) \div 100.$$

### 4.10.3 *Pri* parameter



The *Pri* symbol means *primary*. This screen is only displayed if the C.A 8220 is connected to a 5 A adapter or to the MN93A 5 A clamp.

For all of the other sensors, listed below, which do not require any adjustment, this screen is not displayed:

- MN93 200 A clamp.
- MN93A 100 A clamp.
- C193 1000 A clamp.
- PAC93 1000 A clamp.
- AmpFLEX A193 3000 A.

This parameter configures the primary current of the transformation ratio ().

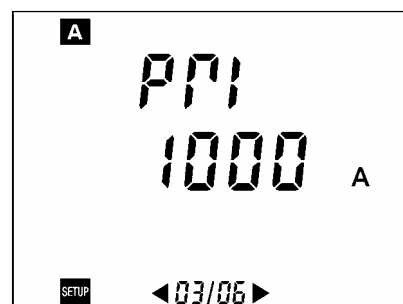



Figure 46: Display of parameter relating to the effective primary current of the intensity transformer.

The  $PPI$  parameter defines the value of the primary effective current of the intensity transformer (IT) or current transformer (CT) for the MN93A clamp (5 A calibre) or the 5 A adapter.

The value is configured using the white and yellow (   ) keys. The minimum and maximum terminals are 0 and 2,999 A.

#### 4.10.4 $SEC$ parameter



The  $SEC$  symbol means *secondary*.

See the comment in paragraph 4.10.3 -  $PPI$  parameter below.

This parameter configures the secondary current of the transformation ratio (  ).

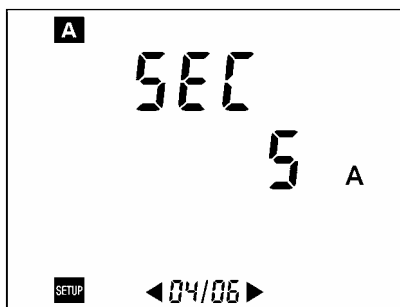





Figure 47: Display of parameter relating to the effective secondary current of the intensity transformer.

The  $SEC$  parameter defines the value of the secondary effective current of the intensity transformer (IT) or current transformer (CT) for the MN93A clamp (5 A calibre) or the 5 A adapter. The value is configured using the white and yellow (   ) keys. The preset values are 1 and 5 A.

#### 4.10.5 $EP_r$ Parameter



The  $EP_r$  symbol means *event per rotation*.

This parameter is designed to configure the rotation speed mode (  ).

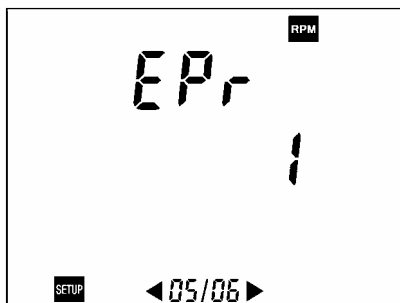



Figure 48: Display of parameter relating to the number of events per rotation of the tachometer signal.

The  $EP_r$  parameter defines the number of events per rotation for the measurement of rotation speed for a machine in operation. If, for example, a tachometer signal provides two pulses per revolutions, this parameter will be set to 2.

The value is configured using the white and yellow (   ) keys. The minimum and maximum terminals are 1 and 99.



The maximum rotation speed is defined by the following formula:  $120000 / EP_r$ .

#### 4.10.6 $thr$ parameter



The  $thr$  symbol means *threshold*.

This parameter is designed to configure the rotation speed mode (  ).





Figure 49: Display of parameter relating to the threshold voltage of the tachometer sensor.

The  $thr$  parameter defines the threshold voltage value used to detect an event (pulse on the tachometer signal).

Since the signal received by the C.A 8220 can be unipolar or bipolar, two types of threshold (0.3 and 1.1 V) can be selected. The recommended selection is as follows:

- bipolar signals: 0.3 V threshold.
- unipolar signals: 1.1 V threshold.

In both cases, the hysteresis is 0.2 V. The value is selected using the white and yellow (   ) keys. The figure on the following page gives the graphs for this hysteresis.

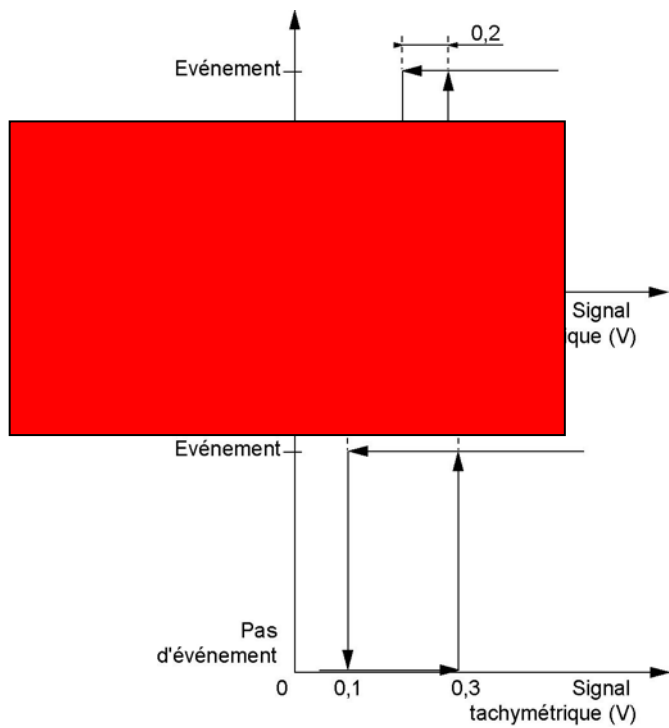









Figure 50: Event determination functions.

## 5. KEYS (TOOLS)

These are presented as follows:

Key	Tool	See §
	Photographs.	5.1
	Visualisation of a photograph or access to the list of photographs.	5.2
	Deletion of one or all the photographs. Re-initialisation of maximum and minimum effective half-cycle voltage or current values.	5.3
	Printing of measures relating to the current mode.	5.4
 	Navigation, incrementation, decrementation or selection of values. Moving between steps.	5.5
	White key for selecting "white" modes. Decrementation of values in <i>Configuration</i> mode.	5.6
	White key for selecting "yellow" modes. Incrementation of values in <i>Configuration</i> mode.	5.7

### 5.1 key

#### 5.1.1 Aim

This key photographs all the measurement pages displayed in the following rotary switch positions .

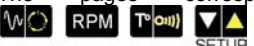

The pages corresponding to the  positions of the rotary switch are not photographed.

This key also enables the user to quit the list of photographs.

#### 5.1.2 Photographing

When the  key is pressed, all the pages in the voltage, current, power, voltage harmonics and current harmonics modes are photographed and the next screen is displayed.

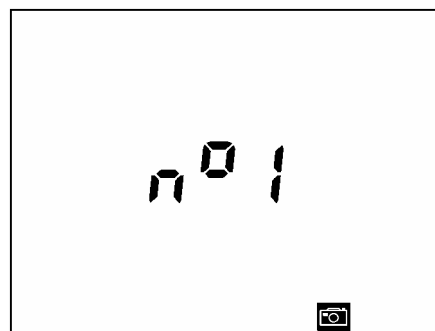



Figure 51: Example of a photograph number.

This screen details the number of the photograph in which the pages have been backed up. The photograph number flashes during the backup process. At the same time, the  icon is displayed at the bottom of the screen.



If the memory used for storing the photographs is full, the message **MEM FULL** (*Memory full*) message is displayed.

#### 5.1.3 Storing a photograph

The photographs are stored in the *flash* memory of the C.A 8220. Switching off the machine does not delete the photographs.

#### 5.1.4 Viewing a photograph

The pages of a photograph can be viewed by pressing the  key (see § 5.2, on page 21).

#### 5.1.5 Deleting a photograph



The photographs can be deleted from the *flash* memory of the C.A 8220 by pressing the  key (see paragraph 5.3).

### 5.2 key

#### 5.2.1 Aim

This key firstly gives access to the list of photographs and secondly, enables the user to select a photograph to be viewed, then exits this view.

#### 5.2.2 Display of list of photographs

Pressing the  key displays a number of a photograph in the list. This list can be navigated using the   keys.



For the **ALL** function, refer to paragraph 5.3.2 on page 22.

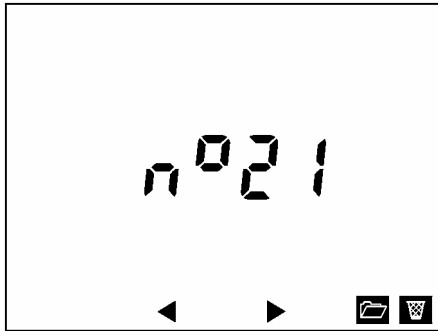







Figure 52: Photograph n°21 will be viewable after pressing the  key.

This list can be exited by pressing one of the white or yellow keys (   ) or one of the  or  keys, or by changing the position of the switch.

If the C.A 8220 memory does not contain any photographs, the list is empty and the next screen is displayed. The appliance then automatically returns to the preview mode.

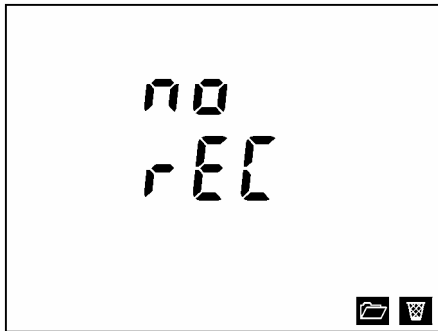





Figure 53: C.A 8220 with no screen photograph...



 The *no REC* symbol means *no record*.





### 5.2.3 Display of pages of a photograph





To view the pages of a photograph selected in the previous point, press the  key.

During the time that the photograph is being viewed, the  icon flashes in the bottom right hand corner of the display.

The different pages can be examined by:

1. Selecting a position among ,  and  on the rotary switch.

 If another position is selected ( , ,  or  ), the *no data* (*no data*) message is displayed.

2. Using the white and yellow keys (   ) to select a mode.
3. Using the   keys to navigate around the different pages of the selected mode.

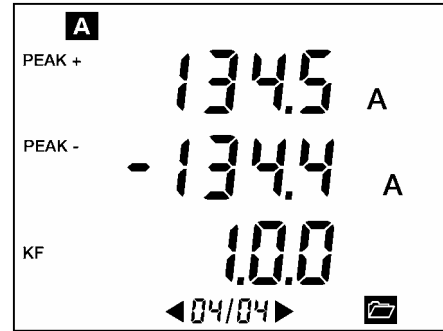





Figure 54: The  icon flashes while the photograph is being viewed.

### 5.2.4 Return to the list of photographs

Pressing the  key quits the photography viewer and returns to the list of photographs.

 If the *no data* message is displayed, pressing the  key goes back to the mode dictated by the switch position.

## 5.3 key

### 5.3.1 Aim

This key deletes one or all of the previously memorised photographs.

### 5.3.2 Selection of photograph(s) to be deleted

Proceed as follows:





1. Press the  key to display the list of photographs. A photograph number is displayed.



Figure 55: Photograph n°21 will be deleted after pressing .

- Use the   keys to:
  - display the number of a specific photograph to be deleted (see illustration above).
  - or **ALL** to select all photographs.

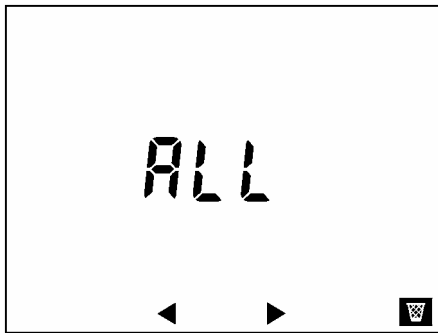









Figure 56: All the photographs are selected to be deleted by pressing .

### 5.3.3 Deletes one or all photographs

Press  to delete the photograph(s) selected.

The number displayed or **ALL** flashes during the deletion procedure.

- After deleting a specific photograph, one of the numbers of the remaining photographs is displayed. If the list does not contain any further photos, the display indicates **no rEE** (No recording); the display then switches automatically to a measurement mode.

 This list can be exited by pressing one of the white or yellow keys (   ) or one of the  or  keys, or by changing the position of the switch.

- If **ALL** has been selected, **no rEE** (No record) is displayed; the display then automatically switches to a measurement mode.

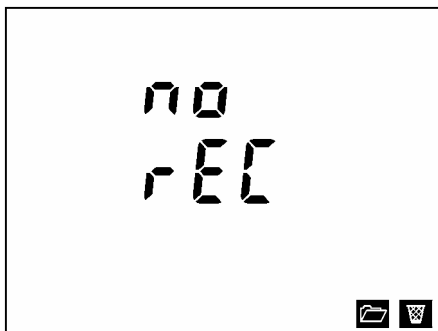



Figure 57: The C.A 8220 has no more memorised photographs.

## 5.4 key

### 5.4.1 Printing a measurement ticket

Before using this key, a thermic serial printer must be connected to the C.A 8220 (Figure 1, rep. 6, on page 5) using the specific optical serial cable provided with the printer.

 Do not use the optical serial cable provided with the appliance to connect the printer.

Pressing this key prints out all the information and measurements relating to the currently selected mode.

 It is not possible to print whilst viewing a photograph.  
This key also allows you to quit the photograph mode.

When the serial line data is transmitting, the  icon flashes

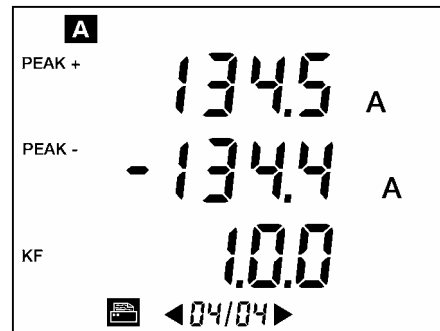



Figure 58: The printer icon flashes during the transfer of the information to the thermic serial printer.

For example, when the rotary switch is in the  position, the voltage mode, pressing the  key prints the following ticket:

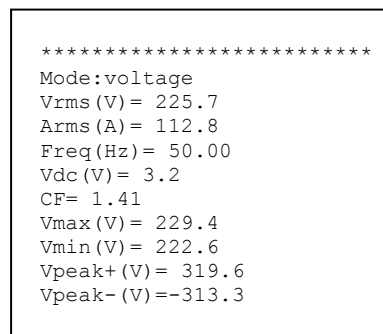

Figure 59: Example of information printed on a ticket issued by the printer.







### 5.4.2 Format of data issued

The optical serial output transmits data at 9600,bauds, in the following format:

- 1 start bit.
- 8 data bits.
- No parity bit.
- 1 stop bit.
- No flow control.

### 5.5 keys







These keys enable the user:

- To navigate between pages for the modes , ,  and .
- To activate or de-activate the balanced three-phase mode for the  mode.
- To select the step in the  modes.



### 5.6 White key

#### 5.6.1 Use

This key enables the:

- Selection of the mode denoted by the white markings around the rotary switch , , ,  and .
- Decrementation of values in the  mode.
- Exiting of the list of photographs.
- Display of the information relating to the C.A. 8220 (see following paragraph).

#### 5.6.2 Information about the appliance

The *Information* mode is displayed when the white key is pressed and held just after switching the appliance on, that is, just after the **OFF** position on the switch. Three pages can be displayed by using the   keys.

- The appliance serial number ( $S_n$  = *Serial Number*) (Figure 60).
- The appliance software version ( $S_{oFt}$  = *Software version*) (Figure 61).
- The appliance hardware version (= *Hardware version*) (**0**).

Paragraph 6.15, on page 28 details the operating process.



Figure 60: Appliance serial number (page 1/3).



Figure 61: Software version number of embedded software (page 2/3).

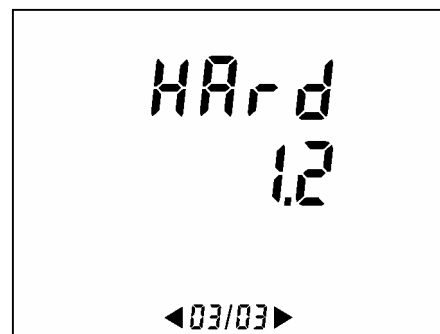







Figure 62: Material version number (page 3/3) **HARD**

The *Information* mode can only be exited by moving the rotary switch back to the **OFF** position.

### 5.7 Yellow key

This key enables the:

- Selection of the mode denoted by the white markings around the rotary switch , , ,  and .
- Incrementation of values in the  mode.
- Exiting of the list of photographs.
- De-activation of the automatic shut-off (see paragraph 6.3.1, on page 27).



## 6. USE



The following precautions for use must be followed:

- Do not connect voltages exceeding 600V RMS to earth.
- When removing and installing battery elements, ensure that the voltage measurement cables are unplugged.

### 6.1 Start-up

The appliance can be started up:

- By changing the position of the rotary switch.
- Or by pressing any key.

In both cases, the final position of the switch should not be the **OFF** position.

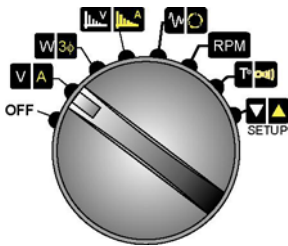

Figure 63: The function switch.

The C.A 8220 displays 3 screens as follows:

- First screen:** display of all 172 activable segments.

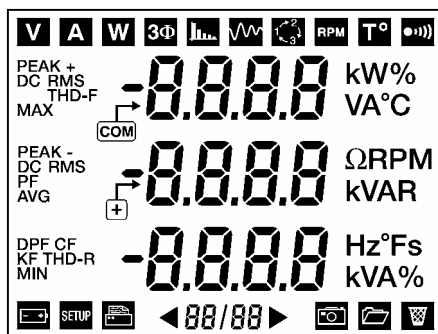

Figure 64: The first screen on start-up.

- Second screen:** display of type of appliance, that is, the C.A 8220.



Figure 65: The second screen on startup (no current sensor connected).



If, when plugged in, a current sensor is connected to the C.A 8220, the bottom of the display screen indicates (Figure 66) the type of current sensor connected, with the following code:

Message	Connection with
PA [	PAC93 1000 A clamp.
Πn	MN93 200 A clamp.
Πn A	MN93A 100 A or 5 A clamp.
[	C193 1000 A clamp.
Πn PF	AmpFLEX A193 3000 A.
Ad AP	Three-phase 5 A adapter.

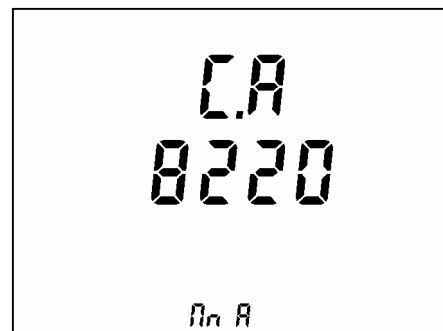

Figure 66: The second screen to be displayed after start-up (with message of current sensor connected).



The type of current sensor is automatically detected and updated every second.

- **Third screen:** displays the measurement page corresponding to the position of the switch.

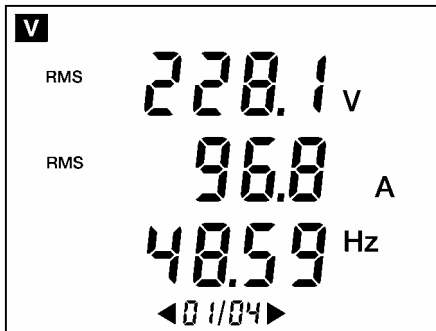

Figure 67: Example of third screen (function of the position of the rotary switch).

The C.A 8220 works from a battery only if the battery is sufficiently charged. Refer to paragraph 3.9.3, on page 8 for details. The appliance can be used with the optional mains power unit connected to the jack socket (Figure 68, rep. 1); the presence of the internal battery is therefore not necessary.



Warning: only use the optional external mains power unit in an environment free from any risk of explosion.

## 6.2 Connecting the cables

### 6.2.1 General points

Insert the cables as follows:

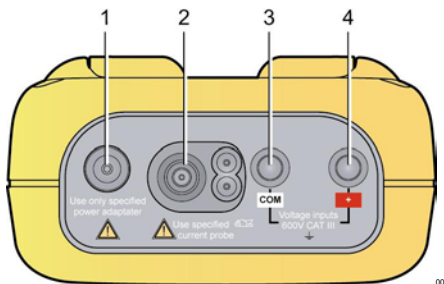

Figure 68: The connectors on the top end of the appliance.

Rep.	Function
1.	External power supply via dedicated power adapter.
2.	4 point entry for amperemetric sensor (MN clamp, C clamp, AmpFLEX, etc.) (the type of current sensor is automatically detected and updated every second).
3.	Security adaptor for voltage measurement cable (negative terminal).
4.	Security adaptor for voltage measurement cable (positive terminal).

Connect the measurement cables to the C.A 8220:

- Voltage measurement: COM and (+) terminals.
- Current measurement: 4 point connector (rep. 2). On the current sensor, do not forget to position the switch (if there is one) to a sensitivity suited to the current to be measured.

The measurement cables are connected to the circuit to be monitored as per the following diagrams.

#### 6.2.1.1 Single-phase network

All the voltages measured will be line to neutral.



The **3Φ** mode (balanced three-phase) will be de-activated (OFF). See § 4.5.2, on page 12.

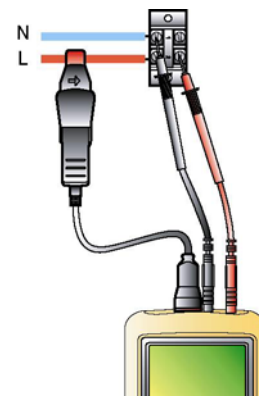

Figure 69: Single phase connection. 005

#### 6.2.1.2 Balanced three-phase network

All the voltages measured will be phase to phase.



The **3Φ** mode (balanced three-phase) will be activated (ON). See § 4.5.2, on page 12.

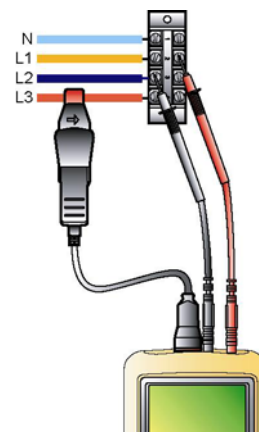











Figure 70: Balanced three-phase connection. 006



The neutral can be present or absent.

### 6.2.2 Use of 5 A adapter or the MN93A 5 A clamp

If the 5A adapter or the MN93A 5 A clamp is used, an adjustment to the transformation ratio (primary current (1 A to 2999 A) / secondary current (1 A or 5 A)) is essential. Proceed as follows:

1. **Connect the current sensor.**
2. **Select the *Configuration* mode by positioning the rotary switch to **
3. **Adjust the sensor's primary current.**
  - Select the  $P_{PI}$  parameter (primary adjustment page) with  .
  - With the white and yellow keys ( ) , adjust the primary current ( $P_{PI}$ ) of the transformation ratio. See paragraph 4.10.3, on page 18 for details.
4. **Adjust the secondary sensor current.**
  - Select the  $S_{EL}$  parameter (secondary adjustment page) with  .
  - With the white and yellow keys ( ) , adjust the secondary current ( $S_{EL}$ ) of the transformation ratio to 1 or 5 A. See paragraph 4.10.4, on page 19 for details.

## 6.3 Automatic shut-off

### 6.3.1 De-activate

Proceed as follows to de-activate the appliance's automatic shut-off:



1. **Stop the appliance.**  
Position the rotary switch to **OFF**.
2. **Switch the appliance on.**
  - Position the rotary switch to any position.
  - When the first screen is displayed (display of 172 segments, see Figure 64, on page 25), pres and hold the yellow key () until a beep is heard.
3. **The screen indicates *noAutoOFF* (No automatic shut off).**  
The appliance does not shut off automatically

### 6.3.2 Re-activate





The automatic shut-off is reactivated each time the C.A 8220 is stopped.

## 6.4 Voltage measurement



Turn the rotary switch to. 

2. **Read data**  
Press   to visualise the four measurement pages. Details in paragraph 4.4.1, on page 10.

## 6.5 Current measurement





1. **Turn the rotary switch to **.
2. **Press the yellow key ().**  
The *current* mode is displayed.
3. **Read data**  
Press the   keys to visualise the four measurement pages. Details in paragraph 4.4.2, on page 11.

## 6.6 Power measurements





1. **Turn the rotary switch to **.
2. **Read data**  
Press the   keys to visualise the two measurement pages. Details in paragraph 4.5.1, on page 12.

## 6.7 Harmonics measurements

### 6.7.1 Voltage harmonics

1. **Turn the rotary switch to  **.
2. **Read data**  
Press the   keys to visualise the 52 measurement pages. Details in paragraph 4.6.1, on page 13.

### 6.7.2 Current harmonics

1. **Turn the rotary switch to  **.
2. **Press the yellow key ().**  
The *Current harmonic* mode is displayed.
3. **Read data**  
Press the   keys to visualise the 51 or 52 measurement pages. Details in paragraph 4.6.2, on page 14.



## 6.8 Inrush measurement

(Inrush: starting current)

1. **Select the  position.**
2. **Refer to paragraph 4.7.1, on page 14.**

## 6.9 Determination of phase rotation

---

1. Turn the rotary switch to .
2. Press the yellow key (  ).  
The *phase rotation* mode is displayed.
3. Refer to paragraph 4.7.2, on page 15.

## 6.10 Measurement of rotation speed

---

1. Turn the rotary switch to .
2. Refer to paragraph 4.8, on page 17.



## 6.11 Temperature measurement

---

1. Turn the rotary switch to .
2. Refer to paragraph 4.9.1, on page 17.

## 6.12 Resistance measurement

---

1. Turn the rotary switch to .
2. Press the yellow key (  ).  
The *Resistance* mode is displayed.
3. Refer to paragraph 4.9.2, on page 17.

## 6.13 Photographing measurements

---

### 6.13.1 Photographing

Refer to paragraph 5.1.2, on page 21.

### 6.13.2 Viewing photographs

Refer to paragraph 5.2, on page 21.

### 6.13.3 Deletion of one or more photographs

Refer to paragraph 5.3, on page 22.

## 6.14 Switching off the appliance

---

The appliance can be switched off:

- Voluntarily by switching the rotary switch to the position.
- Automatically after 5 minutes of inactivity of the main appliance commands (position of rotary switch unchanged or no key pressed).



In both cases, the display indicates **OFF** before shutting off.

Any photographs and all configuration parameters are saved in the *flash* memory.

## 6.15 Displaying information

---

The serial number, the software version and the material version of the C.A 8220 can be displayed on the screen. Proceed as follows:

1. **Switch the appliance to OFF.**  
Turn the rotary switch to **OFF**.
2. **Switch the appliance back ON.**
  - Turn the rotary switch to any position.
  - When the first screen is displayed (display of 172 segments, see Figure 64, on page 25), press and hold the white key (  ) until the first information page is displayed (see § 5.6.2, on page 24).
3. **The information pages can be navigated by using the   keys.**  
See § 5.6.2, on page 24.
4. **Switch the appliance to OFF.**  
Turn the rotary switch to **OFF**.

## 6.16 Power supply for C.A 8220

---

### 6.16.1 Changing the battery

Refer to paragraph 7.2.1, on page 29.

### 6.16.2 Mains operation during measurement process

Refer to paragraph 3.9.4, page 8.

# 7. MAINTENANCE

## 7.1 Important recommendation

Only use recommended spare parts when performing maintenance. The manufacturer cannot be held responsible for any accident that may occur following any repairs carried out by repair technicians outside its own after-sales service or non-approved repair technicians.

## 7.2 Battery



**Do not expose standard batteries or rechargeable batteries to fire.**  
**Do not short-circuit the battery or rechargeable battery terminals.**

### 7.2.1 Changing the battery

When changing the battery (standard batteries or rechargeable batteries), the C.A 8220 MUST be unplugged from the mains power supply and from the measured network; the appliance should no longer be connected to any voltage source. The C.A 8220 saves the photographs of the screens and the configuration after the batteries are removed.

The electrical power supply for the C.A 8220 is ensured via six elements (standard or rechargeable batteries) (rep. 1) in AA format (LR6 - NEDA 15A). The battery life is detailed in paragraph 3.9.2, on page 8).

The elements can be accessed at the back of the C.A 8220, by turning the lock a quarter turn (rep. 2) anti-clockwise using a coin (rep. 3) anti-clockwise using a coin (rep. 3).

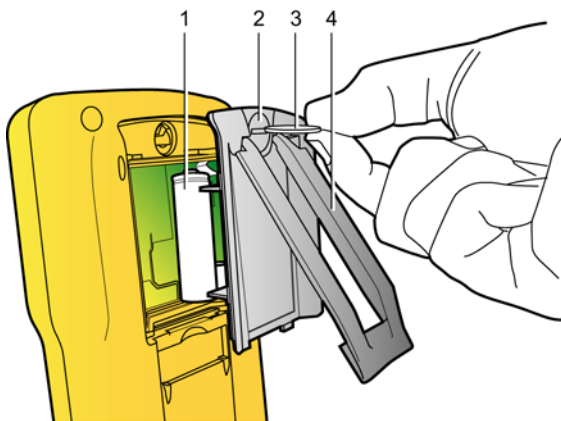

Figure 71: Accessing the battery elements.

003

### 7.2.2 Recharging the rechargeable batteries

The C.A 8220 does not recharge its own rechargeable batteries. These must be recharged on an external charger available as an optional extra, after removing the batteries from the C.A. 8220

## 7.3 Cleaning the unit

Clean the unit with a clean cloth lightly dampened with soapy water. Rinse with a damp cloth. **Do not use solvents.**

## 7.4 Metrological check

**As with all measurement or test appliances, a periodic check is necessary.**

It is recommended that this appliance be checked on a yearly basis as a minimum. For periodic checks and calibrations, contact our COFRAC accredited metrology laboratories or the MANUMESURE agents.

Information and contact details on request:

Tel.: 02 31 64 51 43

Fax: 02 31 64 51 09

## 7.5 Repair

### 7.5.1 Repair under guarantee and outside guarantee period

Send the appliances to one of the regional agents for MANUMESURE, approved by CHAUVIN ARNOUX. Information and contact details on request:

Tel.: (00 33) 02 31 64 51 43

Fax: (00 33) 02 31 64 51 09

### 7.5.2 Repairs outside mainland France

For all repairs under guarantee or outside the guarantee period, return the appliance to the distributor.

## 7.6 Updates to the embedded software

The embedded software of the C.A 8220 can be updated by the user with the optical link provided with the appliance and an update software available on the Chauvin Arnoux website ([www.chauvin-arnoux.com](http://www.chauvin-arnoux.com)).



**Warning: the updating of the embedded software requires all data to be deleted (configuration, photographs).**

Back up data to be kept on a PC using the dedicated software before proceeding to update the embedded software.

Updates to the embedded software depend on its compatibility with the material version of the appliance. The material version number can be displayed when the C.A 8220 is switched on (see paragraph 5.6.2, on page 24).

## 7.7 Sensors

---

The current sensors should be maintained and calibrated as follows:

- Clean by wiping with a sponge dampened with soapy water and rinse in the same way with clean water, then dry rapidly.
- Keep the clamp head gaps (MN93A, MN93, C193 and PAC 93) perfectly clean by wiping with a cloth. Oil the visible metal parts lightly to avoid rust.
- Perform a calibration check every 2 years.

## 8. GENERAL CHARACTERISTICS

### 8.1 Unit

Unit:	Protective elastomer cover.
Connectors:	Two voltage input sockets. a special current connector (automatic current sensor recognition) A connector for the mains power adapter. A connector for the optical serial link.
Keys:	for tools. Use with gloves provided.
Switch:	rotary, for mode selection.
Support stand:	to maintain the appliance in a 30° to horizontal position.
Battery compartment:	to access the battery (at the back of the appliance).
Dimensions:	211 mm x 108 mm x 60 mm.
Mass:	840 g (with batteries).

### 8.2 Power units

#### 8.2.1 Mains power supply unit

Type:	External transformer unit (European or American) category III, 600 V RMS.
User guide	230 V ± 10 % @ 50 Hz or 120, V ± 10 % @ 60 Hz (depending on type of unit).
Maximal power:	23.7 VA.

#### 8.2.2 Battery power

For using the appliance without connecting to the mains and for performing measurements during mains power cuts.

Battery:	- either 6 standard batteries provided (non-rechargeable) in AA format (IEC LR6 – NEDA 15A). - or 6 optional rechargeable batteries (rechargeable elements) NiMH or NiCd in AA format (IEC LR6 – NEDA 15A).
----------	--

Rechargeable batteries:

Capacity:	NiMh: 1800 mAh	
(minimum)	NiCd: 900 mAh	
Nominal voltage:	1.2 V per storage cell, or 7.2, V in total.	
Battery life	<i>Without backlighting</i>	<i>With backlighting</i>
AA standard batteries	> 40 hours	> 20 hours
NiMH 1800, mAh rechargeable batteries	> 30 hours	> 16 hours
NiCd 900mAh rechargeable batteries	> 15 hours	> 8 hours

Temperature:

Use	0°C to 50 °C.
Storage	Standard batteries: from -20 °C to 70 °C. Rechargeable batteries: from -20 °C to 50 °C.

#### 8.2.3 Consumption

##### **With 6 standard batteries (9 V)**

Without backlighting:	50 mA
With backlighting:	90 mA

##### **With 6 rechargeable batteries (7.2 V)**

Without backlighting:	60 mA
With backlighting:	110 mA

## 8.3 Compliance

### 8.3.1 Mechanical protection

In accordance with the CEI 61010-1, the C.A 8220 is considered as a **PORTABLE APPLIANCE (HANDHELD)**.

- Operating position: any.
- Ideal position for operation: on a horizontal surface, resting on its support stand or lying flat.
- Rigidity: compliant with NF EN 61010-1.
- Shock proofing: compliant with NF EN 61010-1.
- Water resistance: IP 54 compliant with NF EN 60529 (electric IP2X for terminals).

### 8.3.2 Electromagnetic compatibility

#### 8.3.2.1 Immunity in accordance with NF EN 61236-1 A2

Compliant with *Criteria A* for all measurements.

- Resistance to electrostatic discharge in accordance with CEI 1000-4-2.
- Resistance to radiation fields in accordance with CEI 1000-4-3.
- Resistance to rapid transients in accordance with CEI 1000-4-4.
- Resistance to electric shocks in accordance with CEI 1000-4-5.
- RF disturbances conducted in accordance with CEI 1000-4-6.
- Voltage interruption in accordance with CEI 1000-4-11.

#### 8.3.2.2 Emission compliant with NF EN 61236-1 A2

Class A material.

### 8.3.3 User safety

- Application of safety rules in accordance with NF EN 61010-1 (isolation of voltage inputs and power unit by impedance protection).
- Type of pollution: 2.
- Installation category: III.
- Service voltage: 600 Vrms.
- Double isolated (□) on the E/S to earth.
- Double isolated (□) between the voltage, power and other E/S inputs.
- Suitable for use outdoors.

## 8.4 Environmental conditions

### 8.4.1 Climatic

The conditions relating to ambient temperature and humidity are as follows:

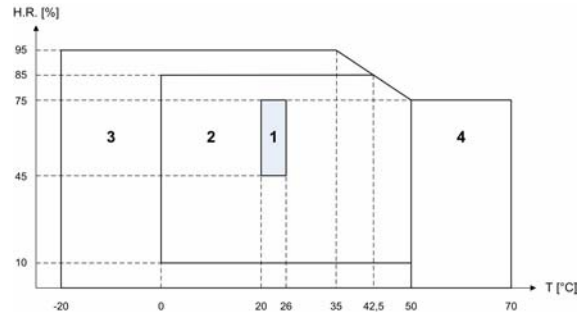

1 = Field of reference

2 = Field of use

3 = Field of storage with rechargeable batteries or standard batteries

4 = Field of storage without rechargeable batteries or with standard batteries

### 8.4.2 Altitude

Use: 0m to 2000 m.

Storage: 0m to 10,000 m.



## 9. FUNCTIONAL CHARACTERISTICS

### 9.1 Reference conditions

Degree of influence	Reference conditions
Ambient temperature:	23 °C ± 3 K.
Humidity (relative humidity):	between 45 % and 75 %.
Atmospheric pressure:	between 860 hPa and 1,060 hPa.
Line to neutral voltage:	from 50 V <sub>RMS</sub> to 600 V <sub>RMS</sub> without DC (< 0.5 %).
Input voltage of standard current circuit:	from 30 mV <sub>RMS</sub> to 1 V <sub>RMS</sub> without DC (< 0.5 %).
Input voltage of Rogowski current circuit:	from 11.8 mVRMS to 118 VRMS without DC (< 0.5 %).
Frequency of electrical network:	50 Hz ± 0.1 Hz and 60 Hz ± 0.1 Hz.
Phase difference:	0° (active power) and 90° (reactive power) closest to 180°.
Harmonics:	< 0.1 %.
Balanced three-phase connection:	De-activated (OFF).

### 9.2 Electrical characteristics

#### 9.2.1 Characteristics of voltage input

Switch positions , , ,  and



Field of use	from 0 V <sub>RMS</sub> to 600 V <sub>RMS</sub> AC+DC phase-neutral (*). from 0 VRMS to 660 VRMS AC+DC phase-phase (*). * : as long as there is a maximum of 600, VRMS to earth.
--------------	--

Input impedance: 451 kΩ.

Admissible overload: 1.2 x V<sub>nom</sub> continuous.  
2 x V<sub>nom</sub> for one second.

Switch positions 

Input impedance: 450 kΩ.

Admissible overload: 600 V<sub>RMS</sub> continuous.

Switch positions 

Voltage in open circuit: ≤ 4.6 V.

Measurement current: 500 μA.

Admissible overload: 600 V<sub>RMS</sub> continuous.

Threshold for buzzer to sound: 20 Ω (by default).

#### 9.2.2 Characteristics of current input

Field of operation: from 0 V to 1 V.

Input impedance: 1 MΩ.

Admissible overload: 1.7 V.

The Amp**FLEX** configuration commutes the current input to an integrator circuit ('Rogowski' chain) capable of interpreting the signals emitted by the sensors of the same name. The input impedance is reduced in this case to 12.4 kΩ.

#### 9.2.3 Bandwidth

Measurement channels: 256 points per period, or:

- For 50 Hz: 6.4 kHz (256 × 50 ÷ 2).
- For 60 Hz: 7.68 kHz (256 × 60 ÷ 2).

Analog to -3 dB: > to 10 kHz.

### 9.2.4 Characteristics of the appliance alone (excluding current sensor)



The **3Φ** mode is considered as deactivated (standard single phase connection).

The following data correspond to an 'ideal current sensor' (perfect linearity and no phase difference). The current characteristics (and their derived quantities) are respectively specified for both of the following configurations: non Amp**FLEX** and Amp**FLEX**.

Measurement		Scope of measurement		Display resolution	Max. error in the reference domain
		Minimum	Maximum		
Frequency		40 Hz	69 Hz	0.01	± (1 pt)
TRMS voltage		6 V	600 V <sup>(1)</sup>	0.1 V.	± (0.5 % + 2 pts)
Continuous voltage		6 V	600 V	0.1 V.	± (1 % + 5 pts)
TRMS current	Non Amp <b>FLEX</b>	$I_{nom} \div 1000$ A	$1.2 \times I_{nom}$ A	0.1 I < 1000 A	± (0.5 % + 2 pts)
				1 A I ≥ 1000 A	± (0.5 % + 1 pts)
	Amp <b>FLEX</b>	10 A	6500 A	0.1 I < 1000 A	± (0.5 % + 1 pts)
				1 A I ≥ 1000 A	
Continuous current		1 A	1700 A <sup>(2)</sup>	0.1 I < 1000 A 1 A I ≥ 1000 A	± (1 % + 1 pts)
Peak current	Non Amp <b>FLEX</b>	0 A	$1.7 \times I_{nom}$ [A] <sup>(3)</sup>	0.1 I < 1000 A	± (1 % + 1 pts)
	Amp <b>FLEX</b>			1 A I ≥ 1000 A	
TRMS current <sup>(6)</sup> half-cycle	Non Amp <b>FLEX</b>	$I_{nom} \div 100$ A	$1.2 \times I_{nom}$ A	0.1 A I < 1000 A	± (1 % + 5 pts)
				1 A I ≥ 1000 A	± (1 % + 1 pts)
	Amp <b>FLEX</b>	100 A	6500 A	0.1 A I < 1000 A	± (1.5 % + 4 pts)
				1 A I ≥ 1000 A	
Peak voltage		6 V	850 V <sup>(5)</sup>	0.1 V.	± (1 % + 5 pts)
half-cycle <sup>(6)</sup> TRMS voltage		6 V	600 V <sup>(1)</sup>	0.1 V.	± (0.8 % + 5 pts)
Crest factor		1	4	0.01	± (1 % + 2 pts)
		4	9.99	0.01	± (5 % + 2 pts)

(1) For measuring line to neutral voltage (phase-neutral). For measuring composed voltage (phase-phase) in balanced three-phase mode, the voltage can reach up to 660 V<sub>RMS</sub> (balanced three-phase network of phase-neutral 380 V<sub>RMS</sub> voltage)

(2)  $1.2 \times 1000 \times \sqrt{2} = 1700 A$

(3)  $1.2 \times I_{nom} \times \sqrt{2} = 1.7 \times I_{nom}$

(4)  $6500 \times \sqrt{2} = 9190 A$

(5)  $600 \times \sqrt{2} = 850 V$  For measuring line to neutral voltage (phase-neutral). For measuring composed voltage (phase-phase) in balanced three-phase mode, the voltage can reach up to  $660 \times \sqrt{2} = 930 V$

(6) **Warning:** The absolute offset value should not exceed 95 % of the peak (crest) value. In other words,  $s(t) = S \times \sin(\omega t) + O$ , will therefore give  $|O| \leq 0.95 \times S$  (with S positive).

The half-cycle values are MAX and MIN values of the V and A mode and the A<sub>RMS</sub> values used in the Inrush mode.

Measurement		Scope of measurement		Display resolution	Max. error in the reference domain
		Minimum	Maximum		
Active power	Non AmpFLEX	0 W	9999 kW.	4 digits	$\pm (1\%)$ $\text{Cos } \Phi \geq 0.8$
					$\pm (1.5\%+10 \text{ pts})$ $0.2 \leq \text{Cos } \Phi < 0.8$
	AmpFLEX	0 W	9999 kW.	4 digits	$\pm (1\%)$ $\text{Cos } \Phi \geq 0.8$
					$\pm (1.5\%+10 \text{ pts})$ $0.2 \leq \text{Cos } \Phi < 0.8$
Reactive power	Non AmpFLEX	0 VAR.	9999 kVAR	4 digits	$\pm (1\%)$ $\text{Sin } \Phi \geq 0.5$
					$\pm (1.5\%+10 \text{ pts})$ $0.2 \leq \text{Sin } \Phi < 0.5$
	AmpFLEX	0 VAR.	9999 kVAR	4 digits	$\pm (1.5\%)$ $\text{Sin } \Phi \geq 0.5$
					$\pm (2.5\%+20 \text{ pts})$ $0.2 \leq \text{Sin } \Phi < 0.5$
Apparent power		0 VA.	9999 kVA	4 digits	$\pm (1\%)$
Power factor		14	1	0.001	$\pm (1.5\%)$ $\text{Cos } \Phi \geq 5$
					$\pm (1.5\%+10 \text{ pts})$ $0.2 \leq \text{Sin } \Phi < 0.5$

**Note:** The data uncertainties on the power measurements are maximums for  $|\text{Cos}\Phi|=1$  or  $|\text{Sin}\Phi|=1$  and are typical for the other phase differences.

Measurement	Scope of measurement		Display resolution	Max. error in the reference domain
	Minimum	Maximum		
Displacement factor (DPF)	-1	1	0.001	$\pm (1^\circ)$ over $\Phi$ $\pm (5 \text{ pts})$ on DPF
Harmonic rates rank $\in [1; 50]$  Non AmpFLEX ( $V_{\text{RMS}} > 50\text{V}$ $I_{\text{RMS}} > 3 \times I_{\text{nom}} \mp 100$ ) AmpFLEX ( $I_{\text{RMS}} > I_{\text{nom}} \mp 10$ )	0 %	999.9 %	0.1 %	$\pm (1\%+5 \text{ pts})$
Overall harmonic rate (THD-F) rank $\leq 50$	0 %	999.9 %	0.1 %	$\pm (1\%+5 \text{ pts})$
Distortion Factor (THD-R). rank $\leq 50$	0 %	999.9 %	0.1 %	$\pm (1\%+10 \text{ pts})$
K factor	1	99.99	0.01	$\pm (5\%)$
Rotation speed.	6 RPM.	120 kRPM	0.1 RPM. $V < 1 \text{ kRPM}$	$\pm (0.5\%)$
			1 RPM. $1 \text{ kRPM} \leq V < 10 \text{ kRPM}$	
			10 RPM. $10 \text{ kRPM} \leq V < 100 \text{ kRPM}$	
			100 RPM. $V \geq 100 \text{ kRPM}$	
Temperature:	-200.0 °C	850.0 °C	0.1 °C	$\pm (1\% + 1\text{ }^\circ\text{C})^{(1)}$
	-328.0 °F	1562 °F	0.1 °F $T < 1000^\circ\text{F}$	$\pm (1.8\% + 2\text{ }^\circ\text{C})^{(1)}$
			1 °F $T \geq 1000^\circ\text{F}$	
Resistance	0.0 $\Omega$	2000 W	1 $\Omega$ $R < 1000 \Omega$	$\pm (1.5\%+2 \text{ pts})$

(1) An additional influence of 3.5 °C must be added in an environment disturbed by radiation fields. In other words, the error in the field of reference in an environment disturbed by radiation fields is  $\pm (1\%+4.5\text{ }^\circ\text{C})$ .

(2) An additional influence of 6.2 °F must be added in an environment disturbed by radiation fields. In other words, the error in the field of reference in an environment disturbed by radiation fields is  $\pm (1\%+8\text{ }^\circ\text{F})$ .

### 9.2.5 Current sensor characteristics

These characteristics are provided after linearization. The sensor errors are compensated by a typical correction inside the appliance. This typical correction is carried out in phase and in amplitude depending on the type of sensor connected (automatically detected) and on the gain of the current acquisition chain used.

The measurement error in RMS current and the phase error are additional errors (they must therefore be added to the those of the appliance alone) given as influences on calculations carried out by the power analyser (powers, power factors, displacement factors, etc.).

Type of sensor	TRMS current	Maximal error on $I_{RMS}$	Maximal error on $\Phi$
<b>PAC93 clamp 1000 A</b>	[1A ; 10 A[	$\pm (1.5 \% + 1 \text{ A})$	N.S.
	[10 A ; 100 A[		$\pm (2^\circ)$
	[100 A ; 800 A[	$\pm (3 \%)$	$\pm (1.5^\circ)$
	[800 A ; 1200 A[	$\pm (5 \%)$	
	[1200 A ; 1400 A] <sup>(1)</sup>		
<b>C193 clamp 1000 A</b>	[1 A ; 3 A[	$\pm (0.8 \%)$	N.S.
	[3 A ; 10 A[		$\pm (1^\circ)$
	[10 A ; 100 A[	$\pm (0.3 \%)$	$\pm (0.5^\circ)$
	[100 A ; 1200 A[	$\pm (0.2 \%)$	$\pm (0.3^\circ)$
<b>AmpFLEX A193 3000 A</b>	[10 A ; 100 A[	$\pm (3 \%)$	$\pm (1^\circ)$
	[100 A ; 6500 A[	$\pm (2 \%)$	$\pm (0.5^\circ)$
<b>MN93 clamp 200 A</b>	[0.5 A ; 2 A[	$\pm (3 \% + 1 \text{ A})$	N.S.
	[2 A ; 10 A[		$\pm (6^\circ)$
	[10 A ; 100 A[	$\pm (2.5 \% + 1 \text{ A})$	$\pm (3^\circ)$
	[100 A ; 240 A[	$\pm (1 \% + 1 \text{ A})$	$\pm (2^\circ)$
<b>MN93A clamp 100 A</b>	[100 mA ; 300 mA[	$\pm (0.7 \% + 2 \text{ mA})$	N.S.
	[300 mA ; 1 A[		$\pm (1.5^\circ)$
	[1 A ; 120 A[	$\pm (0.7 \%)$	$\pm (0.7^\circ)$
<b>MN93A clamp 5 A</b>	[5 mA ; 50 mA[	$\pm (1 \% + 0.1 \text{ mA})$	$\pm (1.7^\circ)$
	[50 mA ; 500 mA[	$\pm (1 \%)$	$\pm (1^\circ)$
	[500 mA ; 6 A[	$\pm (0.7 \%)$	
<b>Adaptor 5 A</b>	[5 mA ; 50 mA[	$\pm (1 \%)$	$\pm (1^\circ)$
	[50 mA ; 6 A[	$\pm (0.5 \%)$	$\pm (0^\circ)$

(1)DC only. N.S.: Non Specified.

## 10. APPENDICES

This chapter presents the mathematical formulae used by the C.A 8220 to calculate the various parameters.

### 10.1 Mathematical formulae

#### 10.1.1 Network frequency

Sampling is carried out on the network frequency to obtain 256 samples per period of 40 Hz to 70, Hz. Sampling is essential for calculating reactive power, calculating rates and angles as well as calculations which give the harmonic quantities.



Sampling of the appliance on the network frequency observed is performed by default with the voltage channel. However, if the voltage is insufficient or indeed absent, this sampling process is carried out with the current channel. The appliance can therefore be used without voltage with a current only.

#### 10.1.2 Effective half-cycle value

*Effective half-cycle voltage*

$$V_{dem} = \sqrt{\frac{1}{NechLobe} \cdot \sum_{n:Zéro}^{Zéro\ suivant} V[n]^2}$$

*Effective half-cycle current*

$$A_{dem} = \sqrt{\frac{1}{NechLobe} \cdot \sum_{n:Zéro}^{Zéro\ suivant} A[n]^2}$$

Note: these values are calculated for each half-cycle so that no faults are overlooked. 'NechLobe' is equal to half a NECHPER (which is equal to 256) for a pure sinusoidal signal without offset.

#### 10.1.3 Minimal-maximal half-cycle effective values (min-max)

*For voltage*

$$V_{max} = \max(V_{dem}) , V_{min} = \min(V_{dem})$$

*For current*

$$A_{max} = \max(A_{dem}) , A_{min} = \min(A_{dem})$$

#### 10.1.4 Crest values ('peak')

(calculated each second on the current curve)

*For voltage*

$$V_{pp} = \max(V[n]) , V_{pm} = \min(V[n]) \quad n \in [0..NECHPER - 1]$$

*For current*

$$A_{pp} = \max(A[n]) , A_{pm} = \min(A[n]) \quad n \in [0..NECHPER - 1]$$

#### 10.1.5 Crest factor

(calculated each second on the current curve)

*Voltage crest factor*

$$V_{cf} = \frac{V_{pp} - V_{pm}}{2 \cdot \sqrt{\frac{1}{NECHPER} \cdot \sum_{n=0}^{NECHPER-1} V[n]^2}}$$

*Current crest factor*

$$A_{cf} = \frac{A_{pp} - A_{pm}}{2 \cdot \sqrt{\frac{1}{NECHPER} \cdot \sum_{n=0}^{NECHPER-1} A[n]^2}}$$

#### 10.1.6 Effective value 1s

*Effective voltage*

$$V_{rms} = \sqrt{\frac{1}{NechSec} \cdot \sum_{n=0}^{NechSec-1} V[n]^2}$$

*Effective current*

$$A_{rms} = \sqrt{\frac{1}{NechSec} \cdot \sum_{n=0}^{NechSec-1} A[n]^2}$$

NechSec: Number of samples used for a calculation in a second

#### 10.1.7 Harmonic calculations

(display frequency 1s)

They are carried out by FFT 1024 points (over 4 periods) without windowing (see. CEI 1000-4-7). The V<sub>harm</sub> and A<sub>harm</sub> rates are calculated from real and theoretical parts, (these rates are calculated based on the effective fundamental value).

$$V_{thd} = \frac{\sqrt{\sum_{n=2}^{50} V_{harm}[n]^2}}{V_{harm}[1]}$$

$$A_{thd} = \frac{\sqrt{\sum_{n=2}^{50} A_{harm}[n]^2}}{A_{harm}[1]}$$

### 10.1.8 Current K factor

K factor (KF)

$$Akf = \frac{\sum_{n=1}^{n=50} n^2 \cdot Aharm[n]^2}{\sum_{n=1}^{n=50} Aharm[n]^2}$$

### 10.1.9 Different powers 1s (single-phase connection)

Active power

$$W = \frac{1}{NechSec} \sum_{n=0}^{NechSec-1} V[n] \cdot A[n]$$

Apparent power

$$VA = V_{rms} \cdot A_{rms}$$

Reactive power (calculation **without** harmonics)

$$VAR = \frac{1}{NechSec} \sum_{n=0}^{NechSec-1} VF[n-NECHPER/4] \cdot AF[n]$$

### 10.1.10 Different total powers 1s (balanced three-phase connection)

Total active power

$$W = \frac{-3}{\sqrt{3} \times NechSec} \sum_{n=0}^{NechSec-1} U[n-NECHPER/4] \cdot A[n]$$

Total apparent power

$$VA = \frac{3}{\sqrt{3}} \cdot U_{RMS} \cdot A_{RMS}$$

Total reactive power (calculation **without** harmonics)

$$VAR = \frac{3}{\sqrt{3} \times NechSec} \sum_{n=0}^{NechSec-1} UF[n] \cdot AF[n]$$



U = Phase to phase voltage between phases 1 and 2 (V<sub>1</sub>-V<sub>2</sub>), A = current phase 3.

### 10.1.11 Different rates

Power factor

$$PF = \frac{W}{VA}$$

Displacement factor

$$DPF = \cos(\phi)$$

Cosine of the angle between the voltage and current fundamental.

$$\cos(\phi) = \frac{\sum_{n=0}^{NechSec-1} VF[n] \cdot AF[n]}{\sqrt{\sum_{n=0}^{NechSec-1} VF[n]^2} \cdot \sqrt{\sum_{n=0}^{NechSec-1} AF[n]^2}}$$

## 10.2 Diagram of 4 quadrants

This diagram is used as part of the measurement of power **W30** (§ 4.5.1, page 12).

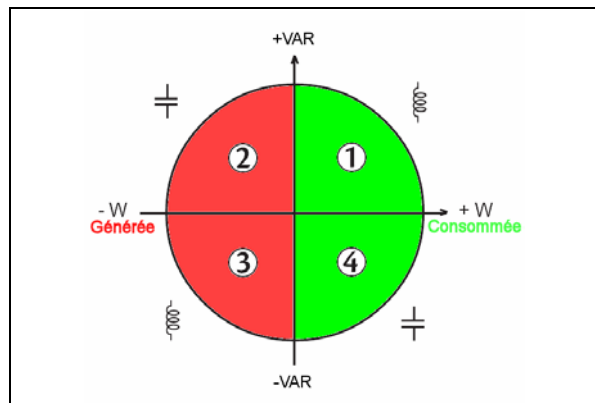

Figure 72: Representation of the 4 power quadrants.

## 10.3 Saturation of input channels

**Monitoring** of the saturation of input channels is carried out when the appliance is in photograph viewing mode or in the following modes:



**No monitoring** of the saturation of input channels is carried out when the appliance is in information display mode or in the following modes:



The following screen is displayed for a second (accompanied by a beep sound) every 2 seconds to indicate that one or both input channels are saturated.

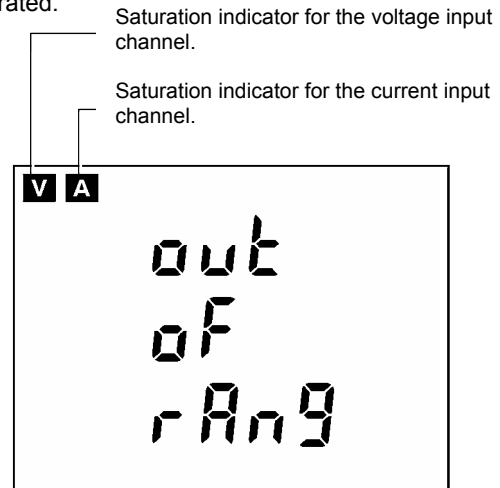

Figure 73: Saturated input channel indicators.



It is normal for the above screen to be displayed when the current sensor is installed or removed.

## 11. TO ORDER

### 11.1 Power Quality Analyser C.A 8220

Power Analyser C.A 8220	P01.1606.20
Power Analyser C.A 8220 with MN93A clamp	P01.1606.21
Power Analyser C.A 8220 with AmpFLEX (450 mm)	P01.1606.22

The appliance is always delivered complete with:

- 6 standard batteries;
- 1 red 1.5 m banana cable (right-right);
- 1 black 1.5 m banana cable (right-right);
- 1 red 4 mm test leads;
- 1 black 4 mm test leads;
- 1 red crocodile clamp;
- 1 black crocodile clamp;
- 1DB9F optical serial cable;
- 1DB9M/USB serial adaptor;
- and these instructions on CD in 5 languages (French, English, German, Italian and Spanish).

### 11.2 Accessories

MN93A BK clamp	P01.1204.34
MN93 BK clamp	P01.1204.25
AmpFLEX, A193, 450mm, BK	P01.1205.26
AmpFLEX, A193, 800mm, BK	P01.1205.31
PAC93 BK clamp	P01.1200.79
C193 BK clamp	P01.1203.23
5A adapter unit (three-phase)	P01.1019.59
Carry-case n°5	P01.1019.59
230 V - 50 Hz mains adapter (600 V CAT III)	P01.1606.40
Set of 6 NiMH AA 1.2 V rechargeable batteries (1800 mAh minimum)	P01.2960.37
Charger for 6 batteries in AA format	P01.2960.40

### 11.3 Spare equipment

MN93A BK clamp	P01.1204.34
AmpFLEX, A193, 450mm, BK	P01.1205.26
Set of 2 1.5 m banana cables (right-right) RD + BK	P01.2950.91
Set of 2 RD + BK crocodile clamps	P01.1018.48
Set of 2 4 mm RD + BK test leads	P01.1018.55
DB9F optical serial cable	P01.2952.69
DB9M/USB Serial adapter	HX0055



04 – 2006

Code / 691604A00-FR-Ed 1

**China** - Shanghai Pujiang Enerdis Inst. CO LTD - 5 F, 3 Rd building, n°381 Xiang De Road  
200081 SHANGHAI. Tel: (021) 65 08 15 43 - Fax: (021) 65 21 61 07  
**Deutschland** - Straßburger Str4 - 77694 KEHL/RHEIN - Tel: (0785 1) 99 26-0 - Fax: (07851) 99 26-60  
**España** - C/ Roger de Flor N°293 - Planta 1 - 08025 BARCELONA - Tel: (93) 459 08 11 - Fax: (93) 459 14 43  
**Italia** - Via Sant' Ambrogio, 23/25 - 20050 BAREGGIA DI MACHERIO (MI) - Tel: (039) 245 75 45 - Fax: (039) 481 561  
**Liban** - P.O BOX 60-154 - 1241 2020 Jal el dib - BEYROUT - Tel: +961 1 890 425 - Fax: +961 1 890 424  
**Österreich** - Slamastrasse 29 / 3 - 1230 WIEN - Tel: (1) 61 61 9 61 - Fax: (1) 61 61 9 61 61  
**Schweiz** - Einsiedlerstrasse 535 - 8810 HORGEN - Tel: (01) 727 75 55 - Fax: (01) 727 75 56  
**UK** - Waldeck House - Waldeck Road - MAIDENHEAD SL6 8BR - Tel: 01628 788 888 - Fax: 01628 628 099  
**USA** - d.b.a AEMC Instruments - 200 Foxborough Blvd, Foxborough, MA 02035 - Tel: (508) 698-2115 - Fax: (508) 698-2118

**190, rue Championnet - 75876 PARIS Cedex 18 – FRANCE**  
**Tel: (33) 01 44 85 44 85 - Fax: (33) 01 46 27 73 89 - [www.chauvin-arnoux.fr](http://www.chauvin-arnoux.fr)**