



Tekscan

industrial sensor catalog

307 West First St., South Boston, MA 02127
tel: 617.464.4500/800.248.3669
email: marketing@tekscan.com
www.tekscan.com

INDUSTRIAL SENSOR CATALOG INTRODUCTION

This catalog is for Industrial matrix Tekscan users and those considering the purchase of a Tekscan Pressure Measurement System. The sensors described have a proprietary connector interface, the “T-Tab,” which can only be used with a Tekscan Pressure Measurement System such as *I-Scan*[®], *I-Scan High Speed*[™], *I-Scan Lite*[™], *I-Scan Handheld*, *BPMS*[™], *CONFORMat*[™], *TireScan*[™], or *Wiper*[™].

A Tekscan Industrial array Pressure Measurement System includes scanning electronics such as a Handle or Cuff that provides sensor excitation, signal conditioning, analog-to-digital conversion and communication. The system will have one or more reusable Tekscan array sensors, and Tekscan’s Microsoft Windows-based pressure display and analysis software.

Each sensor pattern or model has an associated “map,” that is a software “driver” which enables its operation. The map is both a license to use that model sensor as well as instructions to the software for proper sensor performance. The map is sensor-specific software that converts the stream of data from the Handle into a screen display of pressure elements (sensels) in the proper row and column or ring and spoke arrangement to show pressure profiles. It provides information so the analysis software calculates correct values of force, pressure and area. The system must have the appropriate sensor map (license) in order to use each particular sensor. Initially, a Tekscan system comes with a defined set of sensors and their associated sensor map(s). Additional sensors and maps can be purchased at any time and added to the system as measurement tasks change.

Sensors are available in various sizes, shapes, X-Y resolution, and pressure ranges, described below. Most sensors are 0.1 mm (0.004 in.) thick and consist of a large array, or grid, of independent sensing elements or sensels. Please contact Tekscan for sensor and map pricing and availability.

COMPATIBILITY

Most of the sensors described in this catalog have a “T-tab,” compatible with a single “Handle.” A single Handle, can address an array of up to 44 by 52 rows and columns, or 2,288 sensels. Over the years, Tekscan Handles have been produced with a variety of hardware types. Today, Evolution Handles serve the majority of needs with a direct connection to the host PC through its USB port. Applications that require high speed scanning are accomplished with *VersaTek* Handles that connect through a *VersaTek* Hub to the host PC’s USB port. In the past, there were Handles that connected through ISA or PCI interface cards, or Parallel interface boxes. All single Handles are compatible with sensors that have the T-tab.

Some applications, such as tire footprint or fuel cell flow field studies, benefit from sensors with a large number of array elements (sensels) for higher X and Y resolution. Today this is achieved with two or more *VersaTek* Handles connected together to provide Cross-Handle Scanning (CHS). Two *VersaTek* CHS Handles can address an array with up to 88 by 104 rows and columns, or 9,152 sensels. Four *VersaTek* CHS Handles can address an array with up to 176 by 208 rows and columns, or 36,608 sensels. In the past these applications were served by Dual Handles that connected to the host PC through a PCI or ISA card. All Dual Handle sensors, such as the 5026, 6010N, 6020N, 6030N, 7101, 7501, 8000, and 8050 sensors are compatible with both Dual and *VersaTek* CHS Handles. New designs that have two CHS tabs are compatible with existing Dual Handles. New sensor designs that have larger arrays with three or more CHS tabs require *VersaTek* CHS Handles, such as sensor models 8400 and 8405

OTHER PRODUCTS

Other categories of Tekscan sensors are described elsewhere. Medical systems have sensors that connect to a “Cuff” which houses scanning electronics, analog to digital conversion, and communication. Cuffs provide left and right sensor images when attached to a subject’s arm or leg. View the [Medical sensor catalog](#).

FlexiForce[®] sensors respond to single point force loads. [FlexiForce sensors](#) are available in two forms. Sensors with pads connect to the [ELF](#), Tekscan electronics and software. Sensors with pins are intended for user-designed electronics.

SENSOR FAMILIES

Certain sensors have been grouped into “families,” based on their utility for a particular application. In our experience, these groups of sensors provide useful combinations for particular application requirements, based on the shape and pressure ranges available. Examples of some of these families are noted below.

<u>FAMILY</u>	<u>SENSOR MODELS</u>
<i>I-Scan</i> or Standard	5051, 5076 & 5101
Soft Seal	6077 & 6300
Rectangle	6077 & 6300
Small Annular	6220 & 6230
Large Annular	6500, 6510
Finger / Probe	5800, 6900 & 6911
Brake Pad	9850, 9851, 9855N & 9856N
Brake Shoe	6300 & 5511
Joint	4000, 4010N & 4201
Pinch	5501, 5510, 5511, 5515, 5526, 5550, 5555, 5570
Ergonomic	9801 & 9830
High Speed	9500 & 9550
Catalytic Canning	5260, 5511, 5501 & 6300
CMP	5250 & 5051
Seat	5315, 5330, 5350 & 5400N
Vascular	4305, 4308
CMP (<i>VersaTek</i> Handle)	6010N, 6020N, 6030N
Wiper	9901 & 9920
Bead	8100, 8110, 8150 & 8155

SENSOR SELECTION CRITERIA

A number of factors should be considered when selecting a sensor for a test. Sensor shape and pressure range are starting points for making a selection. Frequently, additional factors come into play. These paragraphs are reminders of factors to consider when making sensor selections. A Tekscan representative is available for consultation advice on selecting sensors. In some cases, this will result in a trial experiment with materials and forces that mimic the application of interest.

Please refer to the specific sensor descriptions to help select a sensor and to determine its advantages and limitations in your application. Sensor scanning speed is a function of the software, the hardware type, the sensor layout, and the number of sensing points in the sensor.

1. Sensor Size and Shape

In most cases, it is desirable to select a sensor that covers the pressure measurement area as completely as possible. Multiple sensors can be used to cover a large area, when a single large sensor may have insufficient spatial resolution for the test. In addition, multiple smaller sensors can be placed in widely spaced, yet important, areas to reveal regional pressure distributions with high local spatial resolution while areas without interest have no measurement sensor. Sensors are often cut, punched, shimmed, or trimmed to fit an application when access is an issue.

2. Sensel Density

Sensel density is the number of active sensels per unit of area. More sensels in a given area yield better accuracy for locating individual contact locations; higher pressure distribution resolution; and better ability to visualize small structures. An alternative way to think of resolution is the pitch, or distance between the center of one sensel (sensing element) and its neighbor. Sensors with a greater number of rows and columns per unit of distance (higher density or finer pitch) have better spatial resolution. The smallest X-Y dimension that the system can indicate is the pitch.

Three examples will illustrate. Imagine a sensor with orthogonal rows and columns and the same pitch in both X and Y direction. If the sensor has a pitch of 0.5 in. (12.7 mm) or two sensels per linear inch (0.78 sensels per linear cm), it will have sensel density of 4.0 sensels per square inch (0.62 sensels per square cm). It will report loaded area in increments of 0.25 square inch (1.61 square cm). If a sensor has X and Y pitch of 0.10 in. (2.54 mm) or ten sensels per linear inch (3.93 sensels per linear cm), it will have 100 sensels per square inch (15.5 sensels per square cm). It will report loaded area in increments of 0.01 square inch (6.45 square mm). Some sensors have different row pitch than column pitch. If the sensor has rows with pitch of 0.5 in (12.7 mm) and columns of 0.1 inch (2.54 mm) it will have 20 sensels per square inch (3 sensels per square cm). It will report contact area in increments of 0.05 square inches (32.3 square mm).

Row Pitch	Column Pitch	Sensel density	Sensel area
12.7 mm	12.7 mm	0.62 per square cm	1.61 square cm
0.5 in	0.5 in	4.0 per square inch	0.25 square inch
2.54 mm	2.54 mm	15.5 per square cm	6.45 square mm
0.1 in	0.1 in	100.00 per square inch	0.01 square inch
12.7 mm	2.54 mm	3.00 per square cm	32.3 square mm
0.5 in	0.1 in	20.00 per square inch	0.05 square inch

The system reports pressure and area related to the entire sensel area. If a pointed stylus applies load to one sensel, it may actually contact only a tiny area with very high pressure. However, the reported contact area will be the entire sensel area, and the reported pressure will be derived from the entire sensel area. Thus, in the case of a point load on a large sensel, the system will report a contact area larger than the actual area of contact. The sensel area, including both the active and inactive area, is the minimum area resolution. The sensel reports as either loaded or not – regardless of what percentage of its active surface area has physical contact.

3. Sensor Pressure Range

After sensor shape is selected, consider the pressure range. The first estimate of contact pressure is the total force divided by the total area. However, interface pressures are frequently uneven, especially with hard or non-compliant contacting materials. Using the average pressure often significantly underestimates the peak pressure range of individual locations. When hard surfaces touch, it is typical to have large regions with no contact pressure and small regions with very high contact pressure.

Usually, it is desirable to have some “overhead,” to be able to register peak pressure points of the interface. If the sensor becomes overloaded or saturated in some regions, it will identify locations with high pressures, but not how high those pressures are. When the sensor saturates (reaches a raw digital output value of 255), the saturation pressure is the highest pressure that will be indicated, even if the actual pressure is two, three or ten times the saturation value.

For most sensors, the pressure range label is the pressure applied in a test fixture that yields a digital output of 200. This is called P200. Tekscan systems employ an 8-bit analog to digital converter that has an output of 0-255. Since the stated range is the pressure that yields a raw output of 200 from the sensor, and it can register to a saturation value of 255, there is about 27% headroom, or over-range capability.

The sensors respond somewhat differently to the contact of different materials. That difference may be seen in an application as a higher or lower measurement range than the value labeled on the sensor. Sensors with a range up to 100 psi are tested in a bladder with air pressure through urethane on one side and a hard aluminum or steel surface on the other. Higher range sensors are tested with steel on both sides. Since experimental conditions may be different than that, the pressure range in the experiment at hand may differ from the labeled sensor values.

In addition to avoiding an overload, pressure resolution and the minimum pressures of interest are considerations. Tekscan sensors operate best over a range of 15 to 1. For example, a 1,000 psi range sensor will operate most accurately with an applied pressure of 66 to 1,000 psi. The best possible pressure resolution is P200 range/200. In the case of a 1,000 psi range, the best possible resolution is 5 psi. To avoid spurious output, the first three digital levels are not displayed. So the minimum pressure that a 1,000 psi range sensor will display will be 15 psi.

Most sensors have one or more standard pressure ranges. The standard pressure ranges are selected to serve common applications and based on sales history. Tekscan maintains an inventory of most sensors; so many sensors with standard pressure ranges are in stock, available for immediate shipment. Sensors with non-standard pressure ranges are also sometimes available from stock.

Adjustable sensitivity is available with some Tekscan scanning electronics, such as Evolution Handles. Typically, adjustable sensitivity can change the P200 value up or down by a factor of four. Consider a sensor labeled 100 with best resolution of 0.5 PSI. With low sensitivity, it might be able to behave as a sensor with P200 of 400, and best resolution of 2 psi. Alternatively, with high sensitivity, it may be able to behave as a sensor with P200 of 25 psi and best resolution of 0.125 psi.

Tekscan can also manufacture an existing sensor in a non-standard pressure range. There is a cost to “set-up,” manufacture, and test an existing sensor design in a non-standard pressure range. The set-up cost does not include the cost of the sensors to be ordered. A minimum order quantity of sensors must accompany such an order.

4. Temperature range:

Standard Tekscan sensors are specified to operate over a temperature range from -9° to 60°C (15° to 140°F). The Handle electronics are specified to operate over a temperature range from 0° to 50°C (32° to 122°F). Thus, for elevated or lower temperatures, the Handle should be protected from extremes of temperature.

For high temperature applications, many sensors can be manufactured with different materials to be able to operate over a range from -9° to 200°C (15°F to 400°F). If the application requires higher operating temperatures, please contact Tekscan to discuss whether a particular sensor can be produced with high temperature components.

5. Sensor Durability

Another consideration is durability and thickness. Many users demand the thinnest sensors possible, to minimize disruption to the contacting surfaces. However, the ultra-thin materials are typically not as durable as thicker materials.

Typically, the thicker the sensor, the more durable it will be. However, thicker sensors may affect actual contact and pressure measurement conditions. In many cases, measurement of interface pressures should be taken with the thinnest sensor available. In addition to cushioning peak pressures and filling in areas with low pressure, thicker sensors sometimes exhibit “mechanical cross talk.” “Mechanical cross talk” occurs when a load in one location affects the sensor sufficiently to trigger an adjacent sensing location that is not actually being loaded.

To minimize sensor thickness, Tekscan uses the thinnest polyester that can be successfully produced. All sensor component materials are applied in the thinnest and most uniform manner possible. The resulting thickness of approximately 0.1 mm (0.004 in.) is the thinnest possible, and has the closest row and column spacing achievable by the current state-of-the-art technology. The resulting sensor has exceptional durability and meets the goals of a wide variety of applications. Since thicker polyester is readily available and easier to handle, applications requiring thicker sensors can be made on a custom basis. For applications where it is more important to be rugged than thin, some sensors are made of thicker material, so they are 0.2 mm or 0.3 mm (0.008 in. or 0.012 in.) thick.

6. Sensor Performance

Because the sensing array is a combination of “sensing areas” (the intersection between the conductive rows and columns) and “inactive areas,” (non-responsive areas between the intersections) best results follow from calibration with materials whose compliance is similar to or identical to the material of the test.

In the case of a small point load on a large sensel, the system will report a contact area that is larger than the actual area of contact. The sensel area, including both the active and inactive area, is the minimum spatial resolution. The sensel is either loaded or not - regardless of what percentage of its surface area is loaded. The system will report pressure and area data, based on the sensel area.

Every grid-based sensor has “dead space” - the inactive areas between the sensing intersections. The active portion of the sensor is slightly thicker (0.1 mm) because there are two layers of substrate, two layers of conductive ink, and two layers of pressure sensitive ink. Insensitive areas, where the construction has only two layers of substrate, are thinner (0.05 mm). So in some applications, with rigid or non-compliant contacting surfaces, the entire load is born by the thicker active part of the sensor. With some soft interface materials, the load “fills in” on both the higher active region and adjacent inactive region. This is one of the reasons material compliance has an effect on sensor output. The interaction between material compliance and sensor output is why calibration should be done with material of similar compliance to the material of the test.

The accuracy of the data obtained and sensor performance are closely tied to calibration and equilibration procedures, as recommended by the user’s manual and Help file. In general, you can obtain better results by selecting sensors with finer spatial resolutions and calibrating them with the material of the experiment in the pressure range of interest.

7. Sensor Life

Sensor usage affects how long a sensor will provide good data. Typically, when a sensor is loaded many times, its pressure range increases. It is said to become “colder.” Poor test results can often be traced to using a sensor beyond its useful life or not recalibrating or equilibrating the sensor often enough.

The useful life of a sensor is highly application-dependent. The gentle or aggressive nature of an application will determine how long a sensor will last. If the sensor is placed between two soft surfaces that do not distort the surface shape, with low to moderate pressures, the sensor will last longer. Applications involving two hard surfaces at higher pressures tend to have shorter sensor life. Sensors that are exposed to sliding or shear forces or abrasion across their surface will also degrade more rapidly. Still, it is possible that sensors visibly wrinkled or distressed may continue to provide good results because the active aspects of the sensor are internal. However, sensors with punctures or broken traces usually become non-responsive in those areas. An effective way to evaluate sensor performance is to periodically load it with a known test condition. We suggest recalibration if results begin to vary from what had resulted under a known condition. Replace the sensor if the range of the sensor after recalibration becomes greater than is acceptable or if the sensor is physically damaged.

OTHER CONSIDERATIONS:

Custom Sensor Designs

If none of the existing standard sensor designs seem appropriate, a custom design can be considered for an application. Please contact Tekscan to discuss your needs. It is likely that some preliminary experiments will be suggested with existing sensor designs to explore “proof of concept.” When the requirements are firm up, a quotation will be provided.

Measurement of Large Areas

Some applications involve measuring areas larger than can be covered by a single sensor. Multiple sensors working together create a larger sensing surface or finer X-Y resolution than a single sensor can provide. For example, two Model 8000 sensors may be butted together to measure a tire patch larger than a single sensor. Virtual Systems Architecture™ (VSA) combines the data from multiple sensors to appear in a single image and the output is stored in a single file. Thus multiple individual arrays are combined into a larger virtual array.

The system must have the same number of data scanning Handles as the Virtual Sensor map. Because multiple sensors are involved, multiple orientations are possible. Four sensors could be lined up in a long row or in a square. The virtual sensor map must match the desired orientation. For example, four data scanning Handles can use a VSA map to display four Model 5051 sensors in one playback window. Alternatively, with a different VSA map and the same hardware, two Model 5051 sensors can be displayed in each of two windows.

Protecting the Sensor during Measurement

Some applications benefit from shim stock placed over the sensor. Adding shim stock to an application often affects the compliance of the contacting materials, and may affect the reported pressure, requiring re-calibration.

There can be several benefits from the use of shim stock. If the contacting surfaces have sharp points or abrasive spaces, the shim can protect the sensor. Shim can reduce the effect of these aspects on sensor output in applications which have a tight radius or involve movement.

Tekscan sensors are designed to measure forces normal to the surface of the sensor. If sliding or shear forces are present, shim stock can absorb the shear so it does not affect the sensor. If materials with different compliance or softness will contact the sensor while it has the same calibration factor, shim stock can make the sensor response more consistent. If the application involves liquids, shim can keep the sensor dry. When using shim stock, the effect on reported pressure should be considered.

Information in this catalog is subject to change without notice.

SENSOR MODEL: 3000/3001

SENSOR NAME: *F-SCAN*[®]/*F-SCAN*[®] SPORT/*F-SCAN*[®] LONG HANDLE

Application Example: Gait analysis

Features:

- In-shoe sensor trimmable to any shoe size for foot (plantar) pressure analysis
- No vents
- #3000 is standard *F-Scan* sensor
- #3000 Sport is laminated on both sides with a 0.1mm (.005") flexible protective covering that enhances its durability. For athletic or similarly aggressive applications
- #3001 has longer tab length for use with ski/military/work boots

Requirement: *F-Scan* Cuff

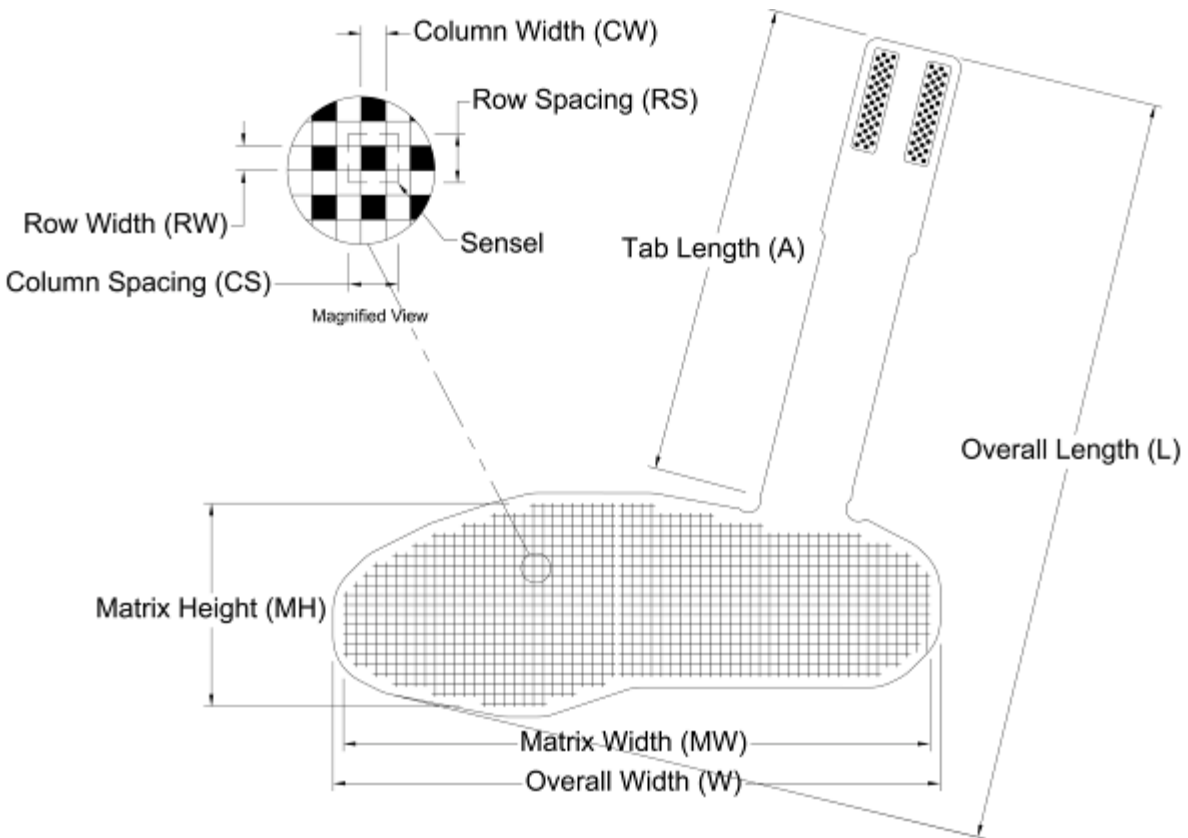

General Dimensions

Sensing Area Dimensions

Model	General Dimensions			Sensing Area Dimensions								Resolution Sensel Density	
	Overall Length L	Overall Width W	Tab Length A	Matrix Width MW	Matrix Height MH	Columns			Rows		Total No. of Sensels		
	(in.)	(in.)	(in.)	(in.)	(in.)	CW	Pitch CS	Qty.	RW	Pitch RS		Qty.	
US 3000	15.31	12.35	9.60	4.20	12.00	0.100	0.200	21	0.100	0.200	60	954	25.0
3001	21.24	12.35	15.61	4.20	12.00	0.100	0.200	21	0.100	0.200	60	954	25.0
Metric 3000	388.9	313.7	243.8	106.7	304.8	2.5	5.1	21	2.5	5.1	60	954	3.9
3001	539.5	313.7	396.5	106.7	304.8	2.5	5.1	21	2.5	5.1	60	954	3.9

SENSOR MODEL: 3000E/3001E

SENSOR NAME: *F-SCAN*[®] EDGE / *F-SCAN*[®] EDGE SPORT / *F-SCAN*[®] EDGE LONG HANDLE

Application Example: Gait analysis

Features:

- In-shoe sensor trimmable to any shoe size for foot (plantar) pressure analysis
- No vents
- #3000E is standard *F-Scan Edge* sensor
- #3000E Sport is laminated on both sides with a 0.1mm (.005") flexible protective covering that enhances its durability. For athletic or similarly aggressive applications
- #3001E has longer tab length for use with ski/military/work boots

Requirement: *VersaTek*[®] Cuff

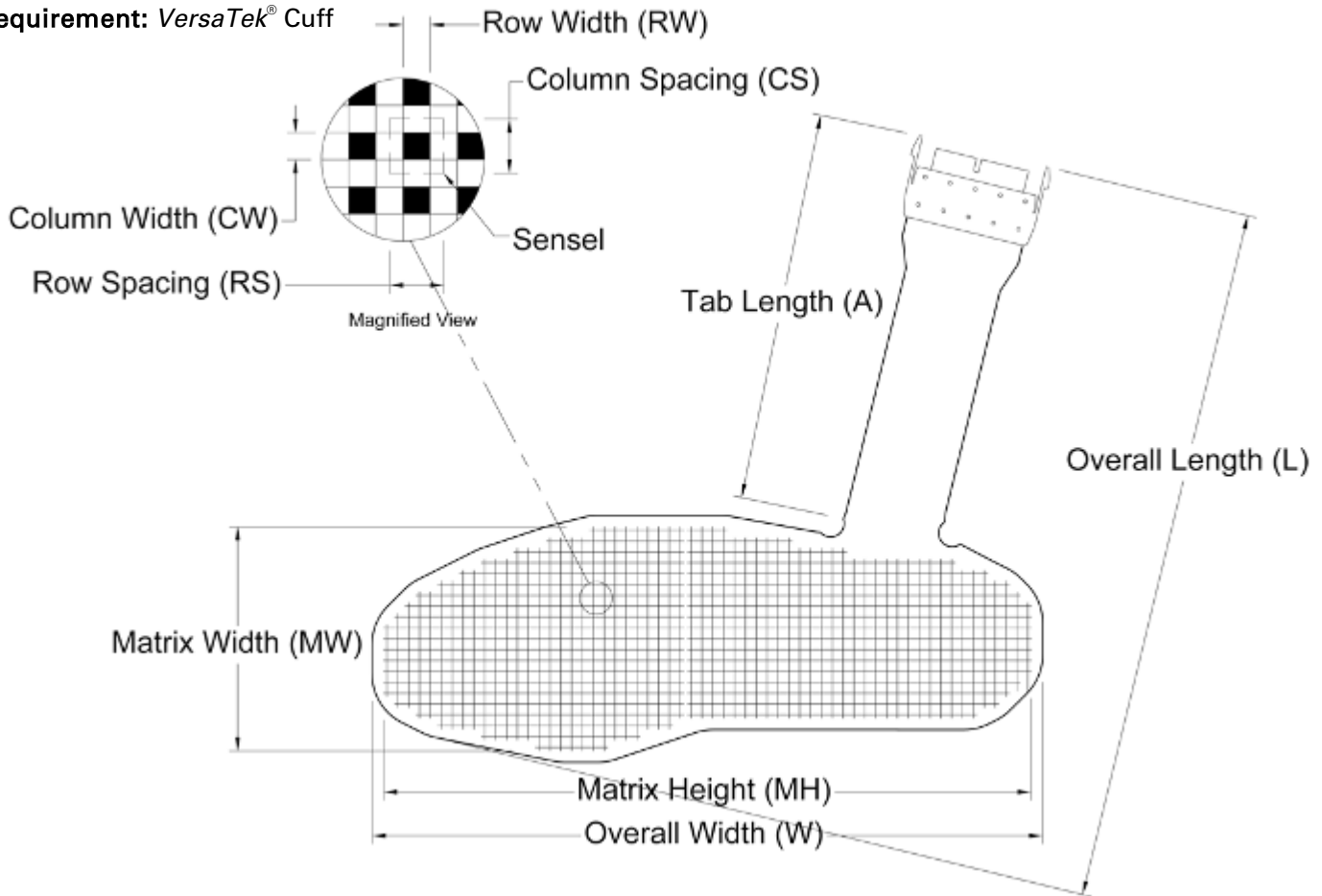

General Dimensions

Sensing Area Dimensions

Model	Overall Length L	Overall Width W	Tab Length A	Matrix Width MW	Matrix Height MH	Columns			Rows			Total No. of Sensels	Resolution Sensel Density
						CW	Pitch CS	Qty.	RW	Pitch RS	Qty.		
US	(in.)	(in.)	(in.)	(in.)	(in.)	(in.)	(in.)		(in.)	(in.)			(sensel per sq. in.)
3000E	12.88	12.35	7.19	4.20	12.00	0.100	0.200	21	0.100	0.200	60	954	25.0
3001E	18.83	12.35	13.20	4.20	12.00	0.100	0.200	21	0.100	0.200	60	954	25.0
Metric	(mm)	(mm)	(mm)	(mm)	(mm)	(mm)	(mm)		(mm)	(mm)			(sensel per sq. cm)
3000E	327.2	313.7	182.6	106.7	304.8	2.5	5.1	21	2.5	5.1	60	954	3.9
3001E	478.3	313.7	335.3	106.7	304.8	2.5	5.1	21	2.5	5.1	60	954	3.9

SENSOR MODEL: 3150

Application Examples:

- Sensor mat used for barefoot analysis
- Large contact surfaces

Features: External vents

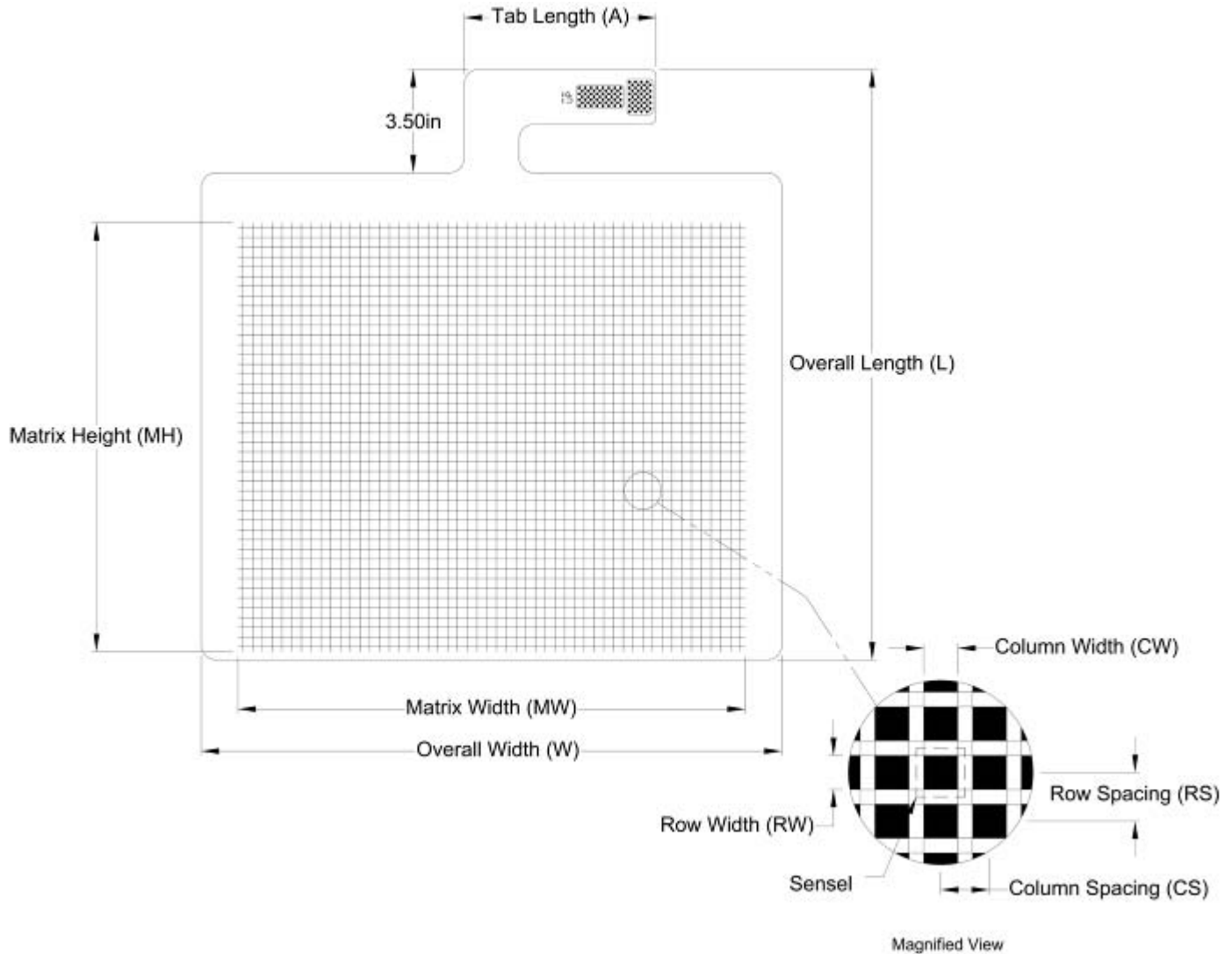

General Dimensions

Sensing Area Dimensions

Model	General Dimensions			Sensing Area Dimensions								Resolution Sensel Density	
	Overall Length L	Overall Width W	Tab Length A	Matrix Width MW	Matrix Height MH	Columns			Rows		Total No. of Sensels		
	(in.)	(in.)	(in.)	(in.)	(in.)	CW	Pitch CS	Qty.	RW	Pitch RS		Qty.	
US 3150	20.00	19.65	7.68	17.16	14.52	0.230	0.330	52	0.230	0.330	44	2288	(sensel per sq. in.) 9.2
Metric 3150	508.0	499.1	195.1	435.9	368.8	5.8	8.4	52	5.8	8.4	44	2288	(sensel per sq. cm) 1.4

SENSOR MODEL: 4000

Application Example: Human joint studies in the knee

Features:

- Two independent, high resolution sensing regions
- No vents

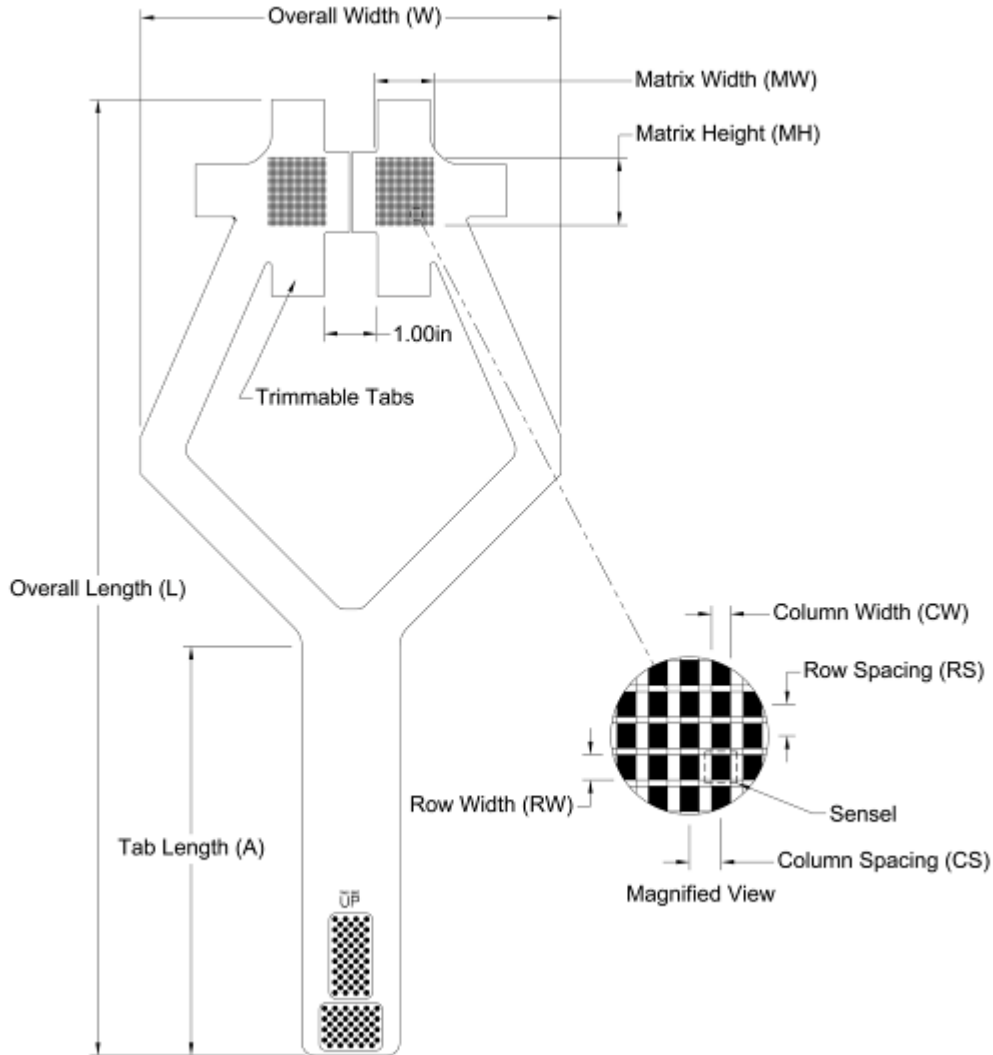

General Dimensions

Sensing Area Dimensions

Model	General Dimensions			Sensing Area Dimensions								Resolution	
	Overall Length L	Overall Width W	Tab Length A	Matrix Width MW	Matrix Height MH	Columns			Rows		Total No. of Sensels		Sensel Density
	(in.)	(in.)	(in.)	(in.)	(in.)	CW	Pitch CS	Qty.	RW	Pitch RS		Qty.	
US 4000	18.19	8.00	7.80	1.10	1.30	(in.)	(in.)	22	(in.)	(in.)	26	572	(sensel per sq. in.) 400.0
Metric 4000	462.0	203.2	198.1	(mm)	(mm)	(mm)	(mm)	22	(mm)	(mm)	26	572	(sensel per sq. cm) 62.0

SENSOR MODEL: 4010N

Application Example: Human joint studies in the knee

Features: Two independent, high resolution sensing regions

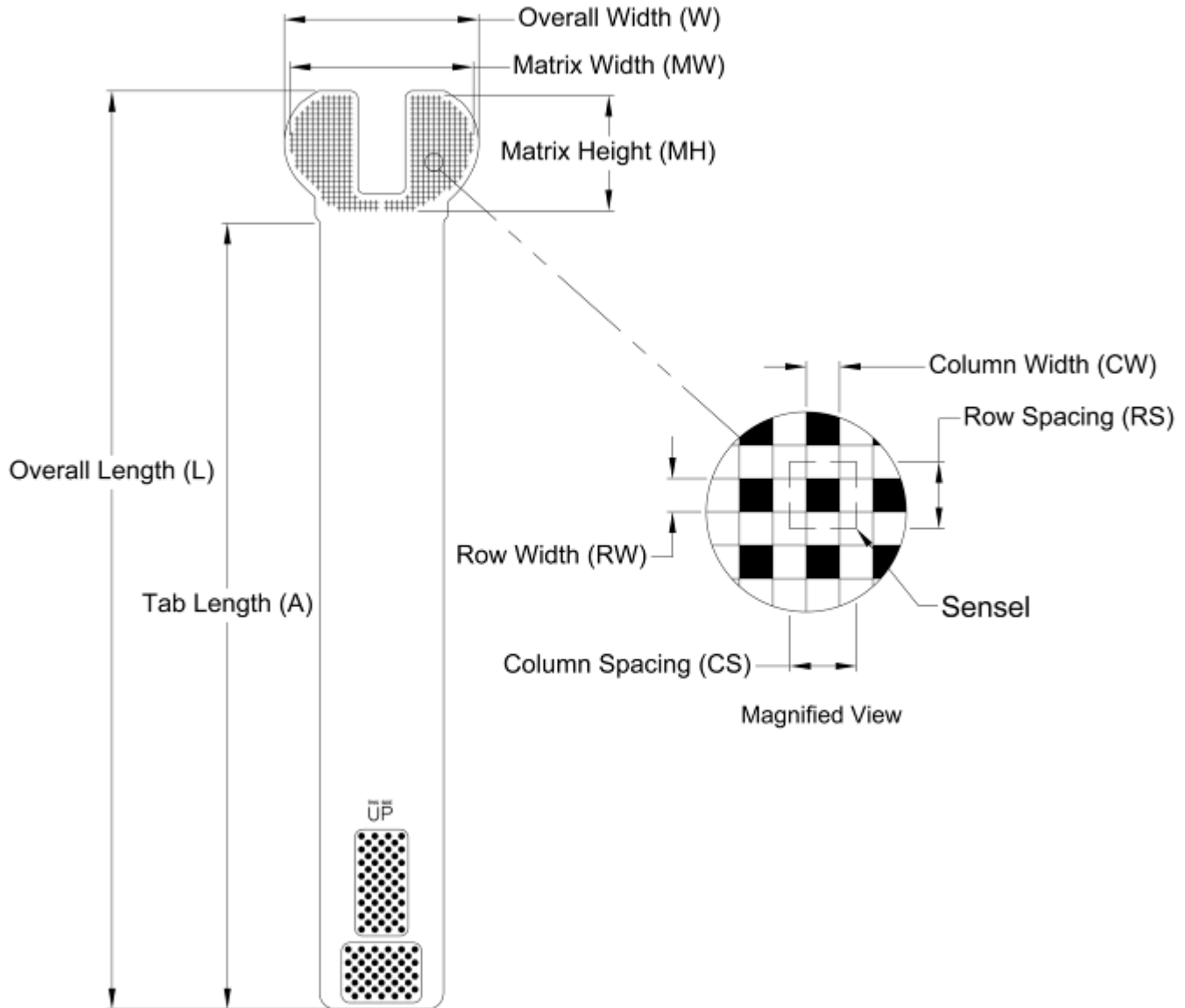

Model	General Dimensions					Sensing Area Dimensions						Total No.of Sensels	Resolution Sensel Density
	Overall Length	Overall Width	Tab Length	Matrix Width	Matrix Height	Columns			Rows				
	L	W	A	MW	MH	CW	Pitch CS	Qty.	RW	Pitch RS	Qty.		
US 4010N	(in.) 13.78	(in.) 2.92	(in.) 11.81	(in.) 2.68	(in.) 1.73	(in.) 0.040	(in.) 0.079	34	(in.) 0.040	(in.) 0.079	22	422	(sensel per sq. in.) 161.5
Metric 4010N	(mm) 350.0	(mm) 74.1	(mm) 300.0	(mm) 68.0	(mm) 44.0	(mm) 1.0	(mm) 2.0	34	(mm) 1.0	(mm) 2.0	22	422	(sensel per sq. cm) 25.0

SENSOR MODEL: 4201

Application Examples:

- Human joint studies in wrists and elbows
- Low pressure ergonomic studies of pressure garments
- Comfort studies with stockings and face masks

Features:

- Can be trimmed from any edge to fit application; sensor needs to be resealed after trimming
- Internal vents

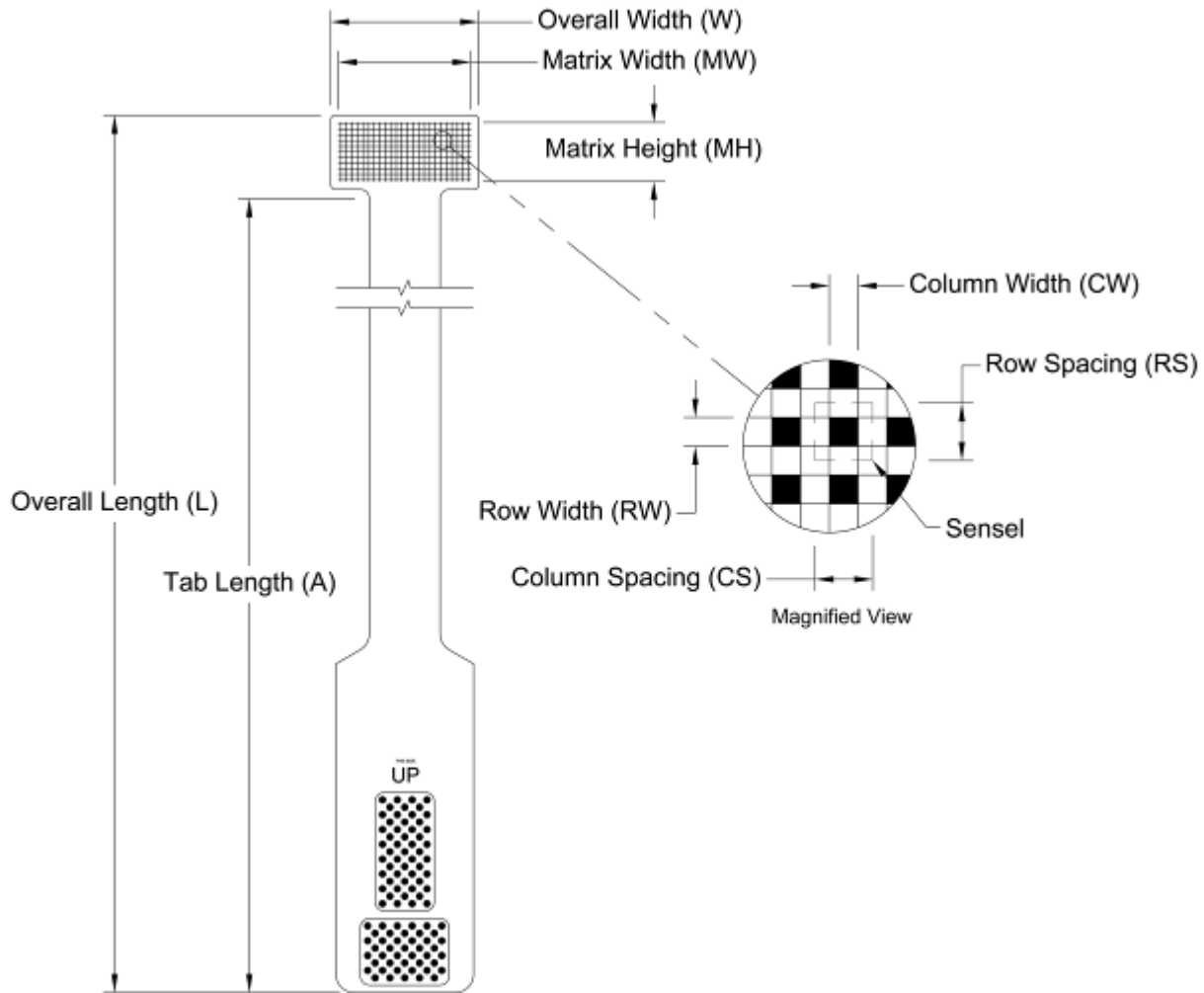

General Dimensions

Sensing Area Dimensions

Model	General Dimensions			Sensing Area Dimensions								Total No. of Sensels	Resolution Sensel Density
	Overall Length L	Overall Width W	Tab Length A	Matrix Width MW	Matrix Height MH	Columns			Rows				
	(in.)	(in.)	(in.)	(in.)	(in.)	CW	Pitch CS	Qty.	RW	Pitch RS	Qty.		(sensel per sq. in.)
US 4201	16.96	2.00	15.84	1.80	0.83	0.045	0.075	24	0.045	0.075	11	264	177.8
Metric 4201	(mm)	(mm)	(mm)	(mm)	(mm)	(mm)	(mm)	24	(mm)	(mm)	11	264	(sensel per sq. cm)
	430.8	50.8	402.4	45.7	21.0	1.1	1.9	24	1.1	1.9	11	264	27.6

SENSOR MODEL: 4205

Application Example: Joint analysis on rotator cuff

Features: Internal vents

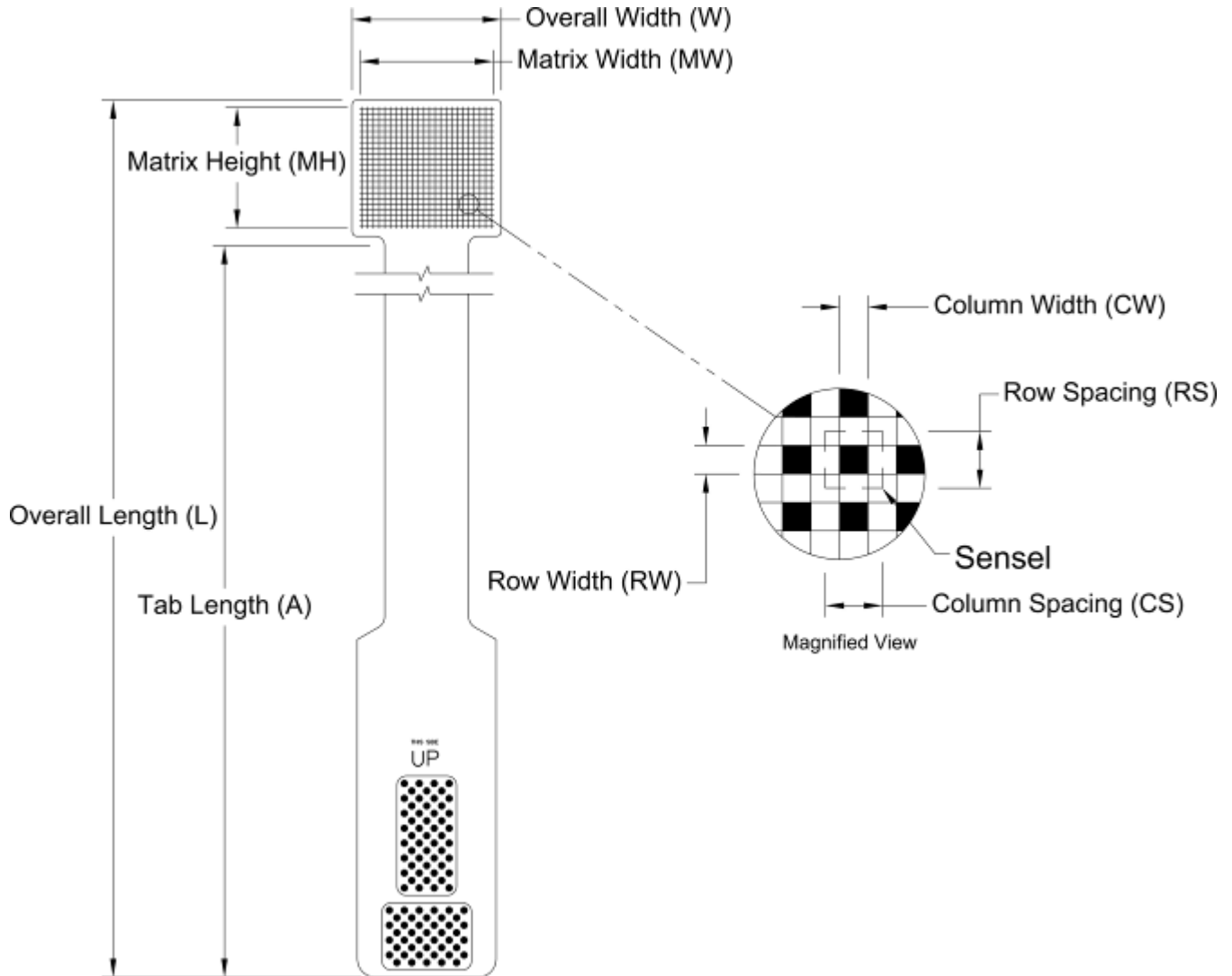

General Dimensions

Sensing Area Dimensions

Model	General Dimensions			Sensing Area Dimensions								Resolution	
	Overall Length L	Overall Width W	Tab Length A	Matrix Width MW	Matrix Height MH	Columns			Rows		Total No. of Sensels	Sensel Density	
						CW	Pitch CS	Qty.	RW	Pitch RS			Qty.
US	(in.)	(in.)	(in.)	(in.)	(in.)	(in.)	(in.)		(in.)	(in.)			(sensel per sq. in.)
4205	17.80	2.00	15.84	1.80	1.65	0.045	0.075	24	0.045	0.075	22	528	177.8
Metric	(mm)	(mm)	(mm)	(mm)	(mm)	(mm)	(mm)		(mm)	(mm)			(sensel per sq. cm)
4205	452.1	50.8	402.3	45.7	41.9	1.1	1.9	24	1.1	1.9	22	528	27.6

SENSOR MODEL: 4255N

SENSOR NAME: GRIP™

Application Examples: Hand grip and ergonomic studies

Features:

- Five independent fingers, each containing multiple sensing regions (20 total)
- Each sensing region can be attached to a different contact point of the hand and fingers
- Each sensing region contains multiple sensing elements providing extensive detail on the grip pressure distribution
- Sensors takes dynamic measurements of both right and left hands
- The sensor's design works with any hand size

Requirements:

- F-Scan® Cuff
- I-Scan® or Research software

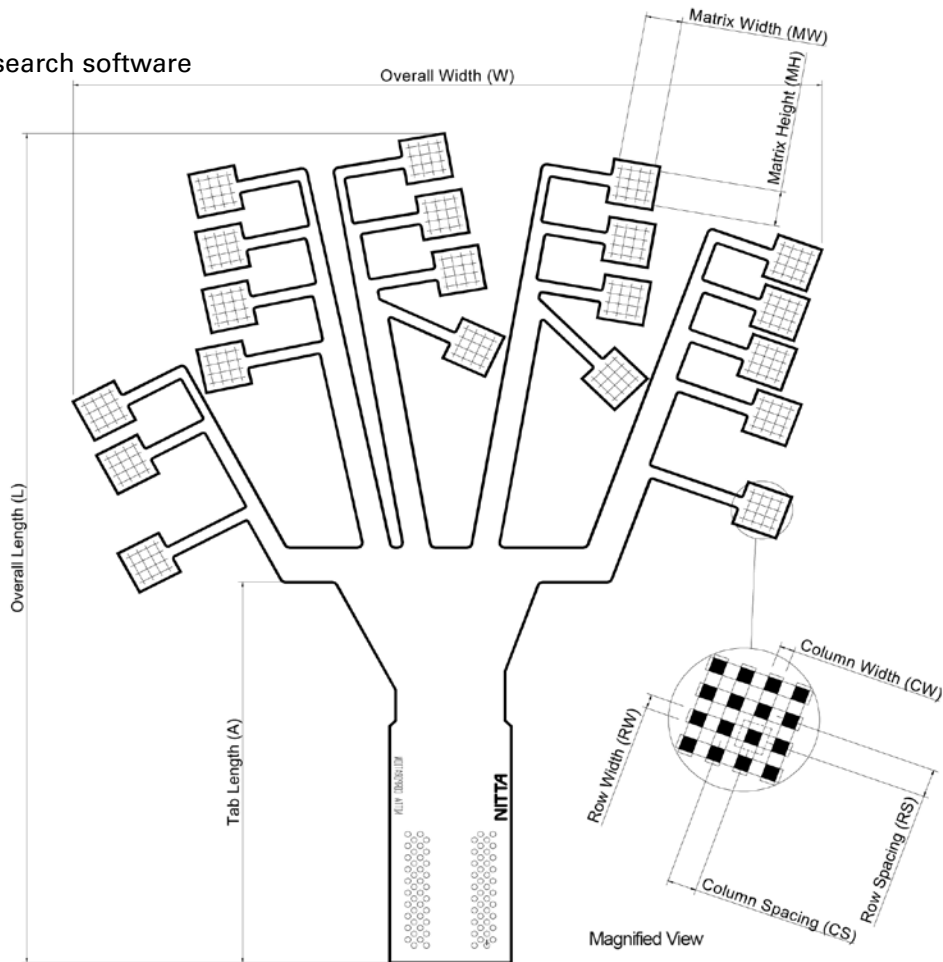

Model	General Dimensions					Sensing Area Dimensions						Total No.of Sensels	Resolution Sensel Density
	Overall Length L	Overall Width W	Tab Length A	Matrix Width MW	Matrix Height MH	Columns			Rows				
						CW	Pitch CS	Qty.	RW	Pitch RS	Qty.		
US 4255N	(in.) 14.17	(in.) 12.13	(in.) 6.5	(in.) 0.63	(in.) 0.63	(in.) 0.079	(in.) 0.157	4	(in.) 0.079	(in.) 0.157	4	320	(sensel per sq. in.) 40.3
Metric 4255N	(mm) 360.0	(mm) 308.0	(mm) 165.0	(mm) 16.0	(mm) 16.0	(mm) 2.0	(mm) 4.0	4	(mm) 2.0	(mm) 4.0	4	320	(sensel per sq. cm) 6.3

SENSOR MODEL: 4256

SENSOR NAME: GRIP™

Application Example: Hand grip and ergonomic studies

Features:

- Five independent fingers, each containing multiple sensing regions (18 total)
- Each sensing region can be attached to a different contact point of the hand and fingers
- Each sensing region contains multiple sensing elements providing extensive detail on the grip pressure distribution
- Sensor takes dynamic measurements of both right and left hands
- The sensor's design works with any hand size

Requirements:

- *F-Scan®* or *Mobile Cuff*
- *I-Scan®* or Research software

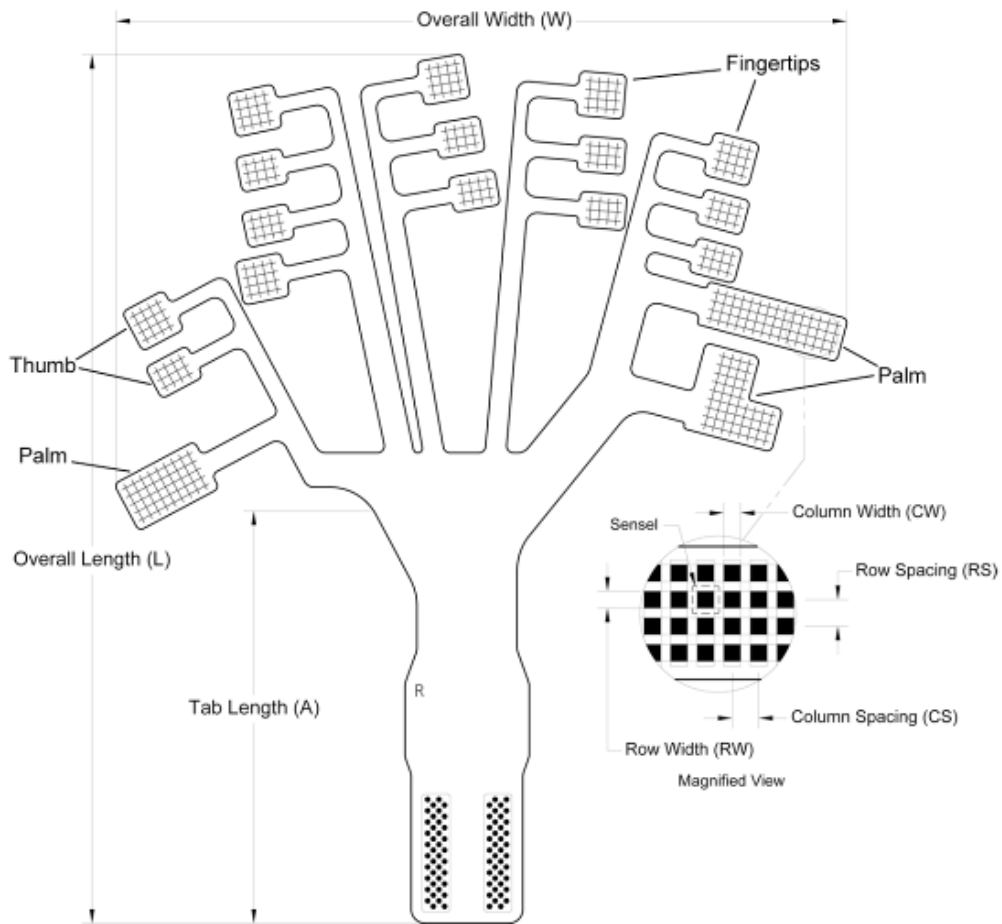

General Dimensions

Sensing Area Dimensions

Model	General Dimensions			Sensing Area Dimensions								Total No.of Sensels	Resolution Sensel Density
	Overall Length L	Overall Width W	Tab Length A	Matrix Width MW	Matrix Height MH	Columns			Rows				
						CW	Pitch CS	Qty.	RW	Pitch RS	Qty.		
US 4256	(in.) 15.44	(in.) 12.99	(in.) 7.30	(in.) Various	(in.) Various	(in.) 0.100	(in.) 0.158	36	(in.) 0.100	(in.) 0.158	23	349	(sensel per sq. in.) 40.3
Metric 4256	(mm) 392.2	(mm) 329.9	(mm) 185.4	(mm) Various	(mm) Various	(mm) 2.54	(mm) 4.0	36	(mm) 2.5	(mm) 4.0	23	349	(sensel per sq. cm) 6.2

SENSOR MODEL: 4256E

SENSOR NAME: GRIP™ EDGE

Application Example: Hand grip and ergonomic studies

Features:

- Five independent fingers, each containing multiple sensing regions (18 total)
- Each sensing region can be attached to a different contact point of the hand and fingers
- Each sensing region contains multiple sensing elements providing extensive detail on the grip pressure distribution
- Sensor takes dynamic measurements of both right and left hands
- The sensor's design works with any hand size

Requirements:

- VersaTek® Cuff
- I-Scan® or Research software

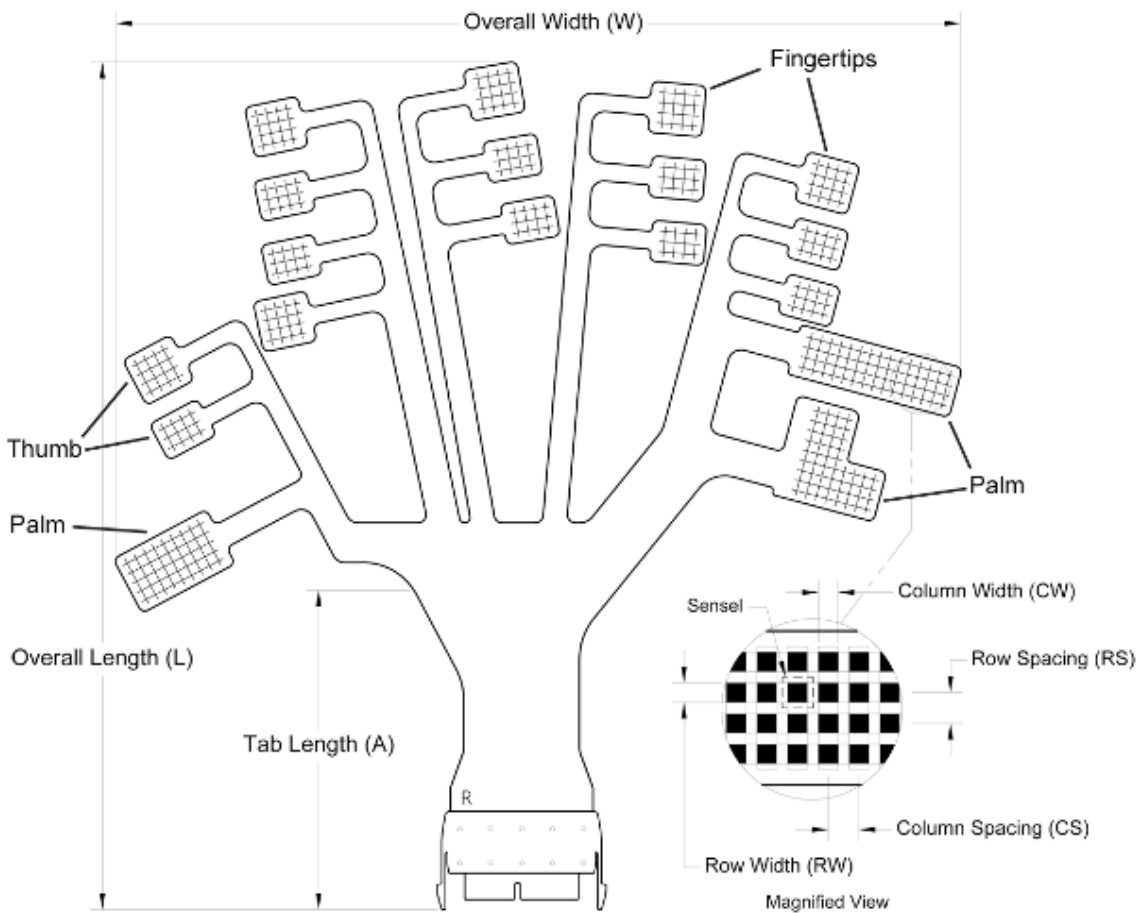

General Dimensions

Sensing Area Dimensions

Model	Overall Length L	Overall Width W	Tab Length A	Matrix Width MW	Matrix Height MH	Columns			Rows			Total No. of Sensels	Resolution Sensel Density
						CW	Pitch CS	Qty.	RW	Pitch RS	Qty.		
US 4256E	(in.) 13.02	(in.) 12.99	(in.) 4.91	(in.) Various	(in.) Various	(in.) 0.100	(in.) 0.158	36	(in.) 0.100	(in.) 0.158	23	349	(sensel per sq. in.) 40.3
Metric 4256E	(mm) 330.7	(mm) 329.9	(mm) 124.7	(mm) Various	(mm) Various	(mm) 2.5	(mm) 4.0	36	(mm) 2.5	(mm) 4.0	23	349	(sensel per sq. cm) 6.2

SENSOR MODEL: 5026

Application Examples:

- Piston and cylinder wall pressures
- Tire tread blocks

Features:

- Extremely high spatial resolution (9,152 sensing elements)
- Internal vent

Requirement: Dual Handles or Two *VersaTek*® Handles

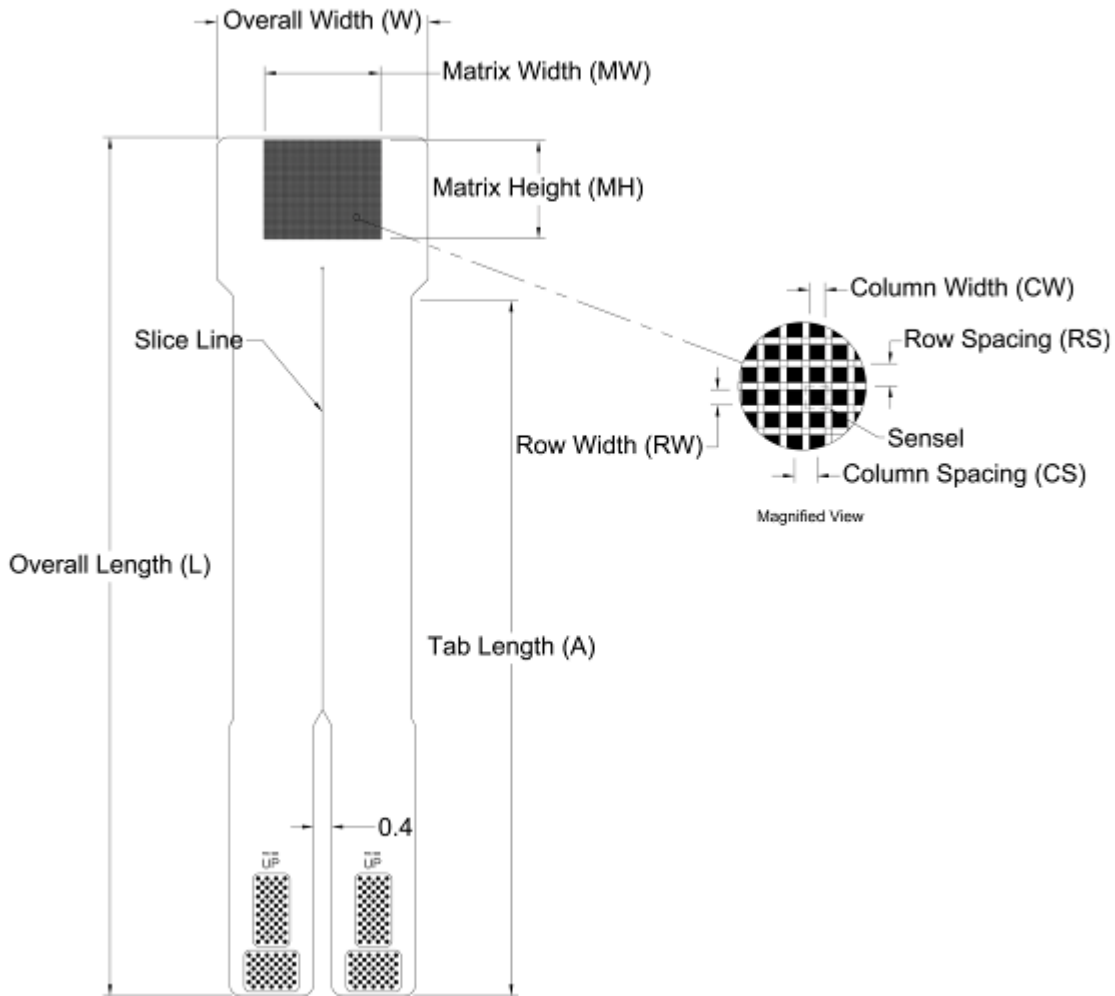

General Dimensions

Sensing Area Dimensions

Model	Overall Length L	Overall Width W	Tab Length A	Matrix Width MW	Matrix Height MH	Columns			Rows			Total No. of Sensels	Resolution Sensel Density
						CW	Pitch CS	Qty.	RW	Pitch RS	Qty.		
US 5026	(in.) 19.05	(in.) 4.69	(in.) 15.42	(in.) 2.60	(in.) 2.20	(in.) 0.008	(in.) 0.025	104	(in.) 0.008	(in.) 0.025	88	9152	(sensel per sq. in.) 1600.0
Metric 5026	(mm) 483.9	(mm) 119.0	(mm) 391.7	(mm) 66.0	(mm) 55.9	(mm) 0.2	(mm) 0.6	104	(mm) 0.2	(mm) 0.6	88	9152	(sensel per sq. cm) 248.0

SENSOR MODEL: 5027

Application Example: Tire tread blocks

Features:

- Extremely high spatial resolution (8,000 sensing points)
- Internal vent

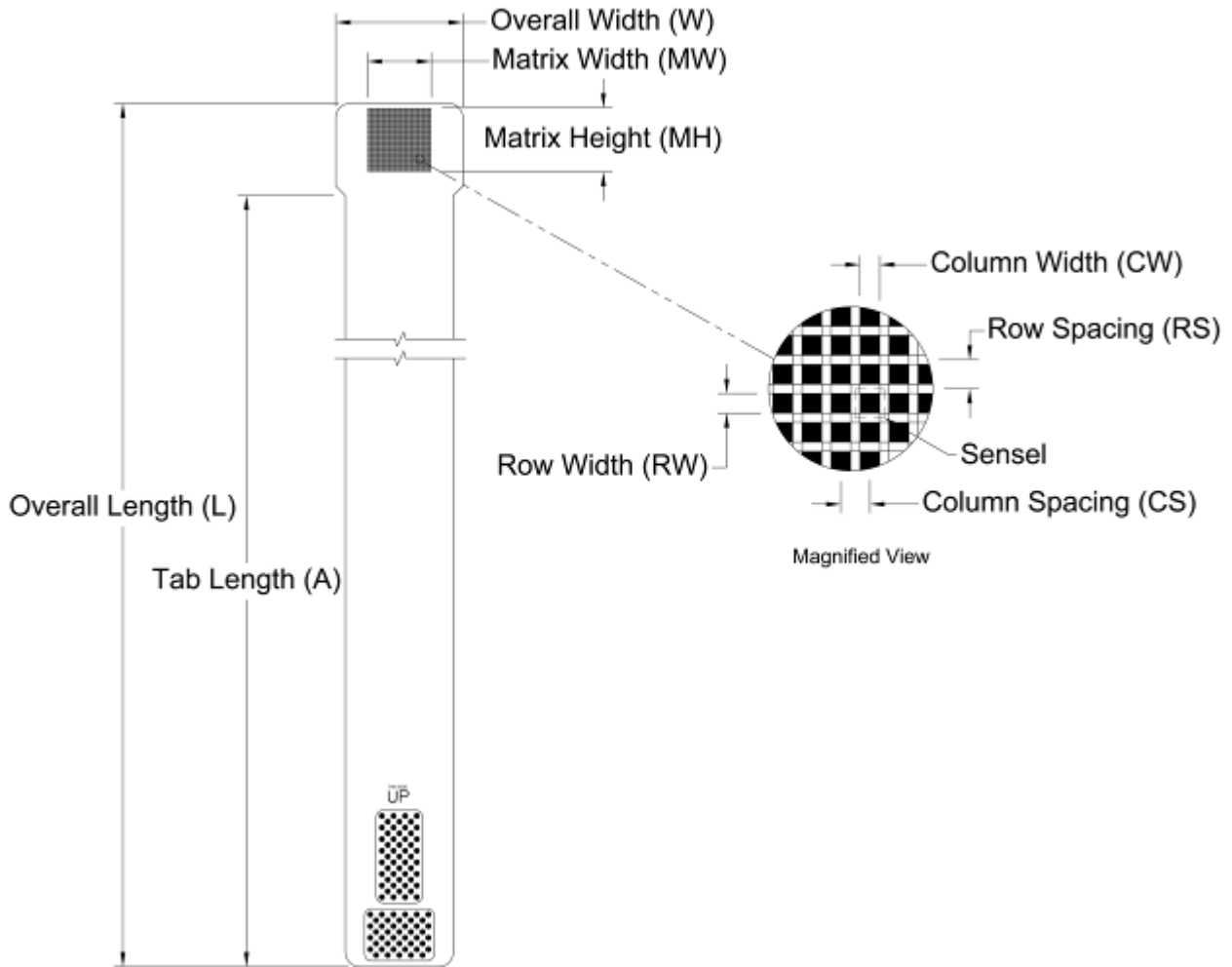

General Dimensions

Sensing Area Dimensions

Model	General Dimensions			Sensing Area Dimensions								Resolution	
	Overall Length L	Overall Width W	Tab Length A	Matrix Width MW	Matrix Height MH	Columns			Rows			Total No. of Sensels	Sensel Density
	(in.)	(in.)	(in.)	(in.)	(in.)	CW	Pitch CS	Qty.	RW	Pitch RS	Qty.		(sensel per sq. in.)
US 5027	20.00	2.19	18.41	1.10	1.10	0.008	0.025	44	0.008	0.025	44	1936	1600.0
Metric 5027	(mm)	(mm)	(mm)	(mm)	(mm)	(mm)	(mm)		(mm)	(mm)			(sensel per sq. cm)
	508.0	55.7	467.6	27.9	27.9	0.2	0.6	44	0.2	0.6	44	1936	248.0

SENSOR MODEL: 5033

Application Example: Ankle joint studies

Features: Internal vents

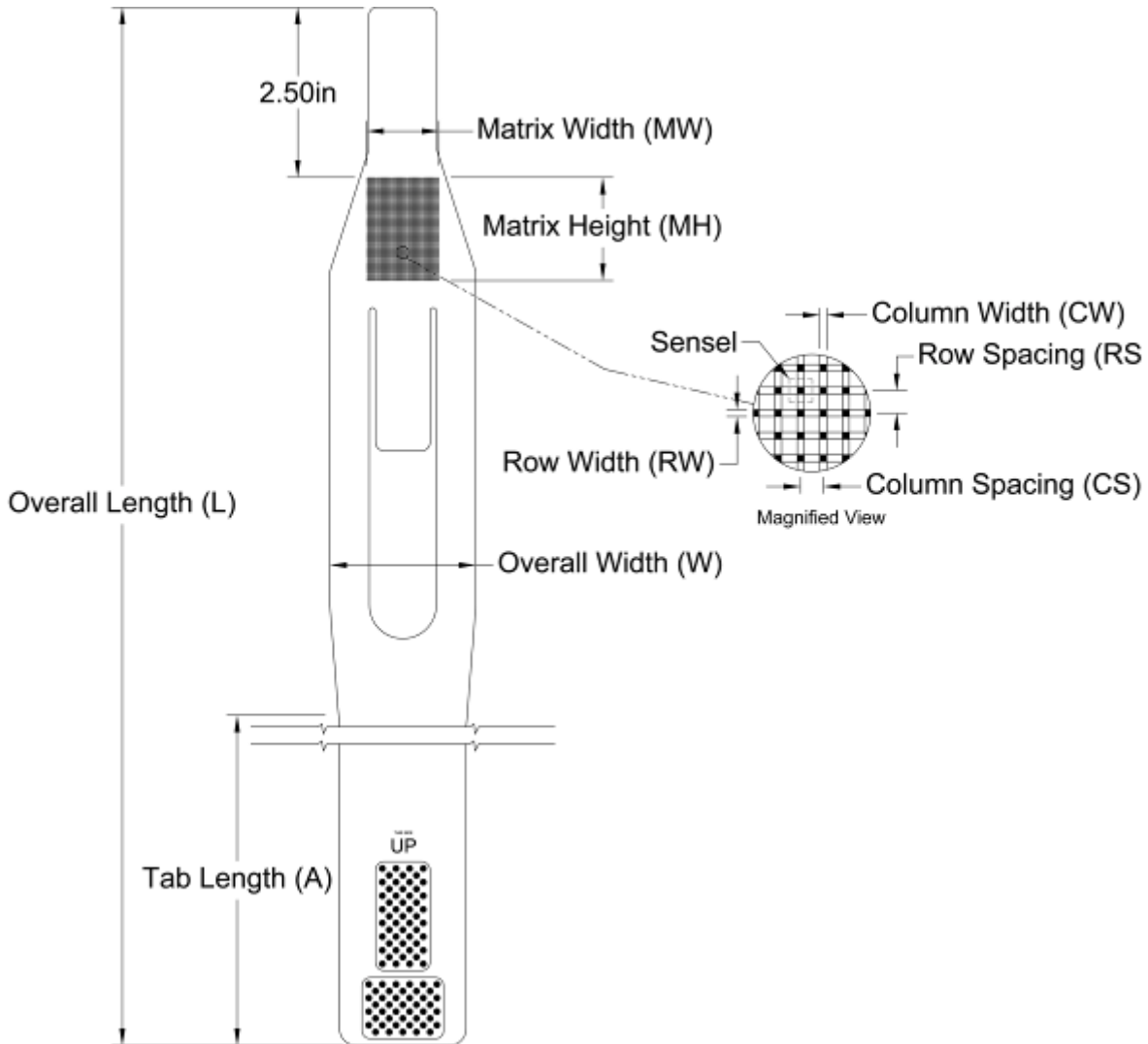

General Dimensions

Sensing Area Dimensions

Model	General Dimensions			Sensing Area Dimensions								Total No. of Sensels	Resolution Sensel Density
	Overall Length L	Overall Width W	Tab Length A	Matrix Width MW	Matrix Height MH	Columns			Rows				
	(in.)	(in.)	(in.)	(in.)	(in.)	CW	Pitch CS	Qty.	RW	Pitch RS	Qty.		(sensel per sq. in.)
US 5033	18.00	2.14	7.43	1.05	1.51	0.010	0.033	32	0.010	0.033	46	1472	929.5
Metric 5033	(mm)	(mm)	(mm)	(mm)	(mm)	(mm)	(mm)	32	(mm)	(mm)	46	1472	(sensel per sq. cm)
	457.2	54.4	188.7	26.7	38.3	0.3	0.8	32	0.3	0.8	46	1472	144.1

SENSOR MODEL: 5040

Application Example: Excellent for general purpose use

Features: Internal vents

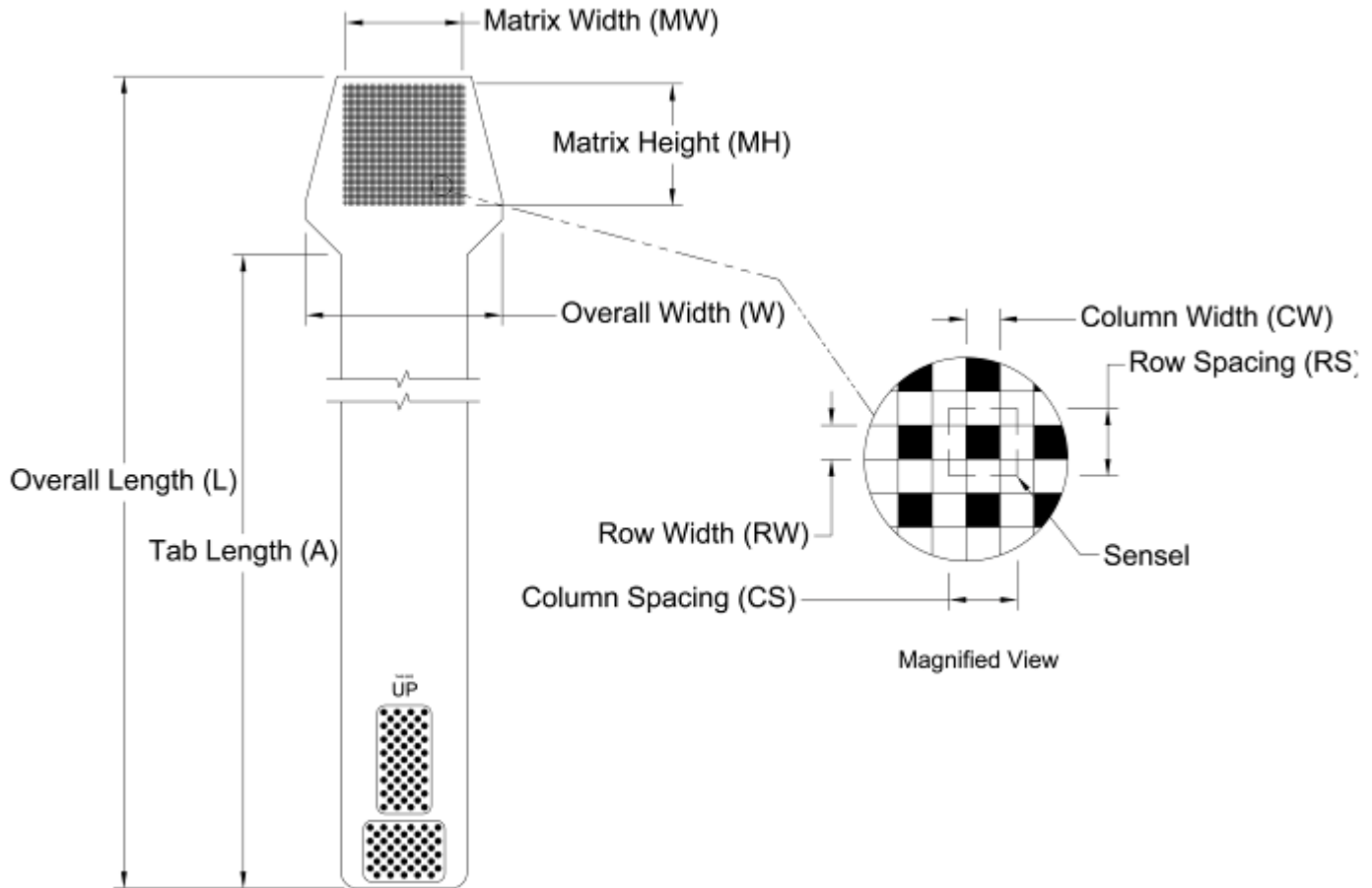

Model	General Dimensions			Sensing Area Dimensions								Resolution Sensel Density	
	Overall Length L	Overall Width W	Tab Length A	Matrix Width MW	Matrix Height MH	Columns			Rows		Total No.of Sensels		
	(in.)	(in.)	(in.)	(in.)	(in.)	CW	Pitch CS	Qty.	RW	Pitch RS		Qty.	
US 5040	20.00	2.89	17.37	1.76	1.76	0.015	0.040	44	0.015	0.040	44	1936	(sensel per sq. in.) 625.0
Metric 5040	508.0	73.4	441.2	44.7	44.7	0.4	1.0	44	0.4	1.0	44	1936	(sensel per sq. cm) 96.9

SENSOR MODEL: 5040N/5150N/5210N

Application Example: Excellent for general purpose use

Features:

- Wide range of available pressures
- Internal vents

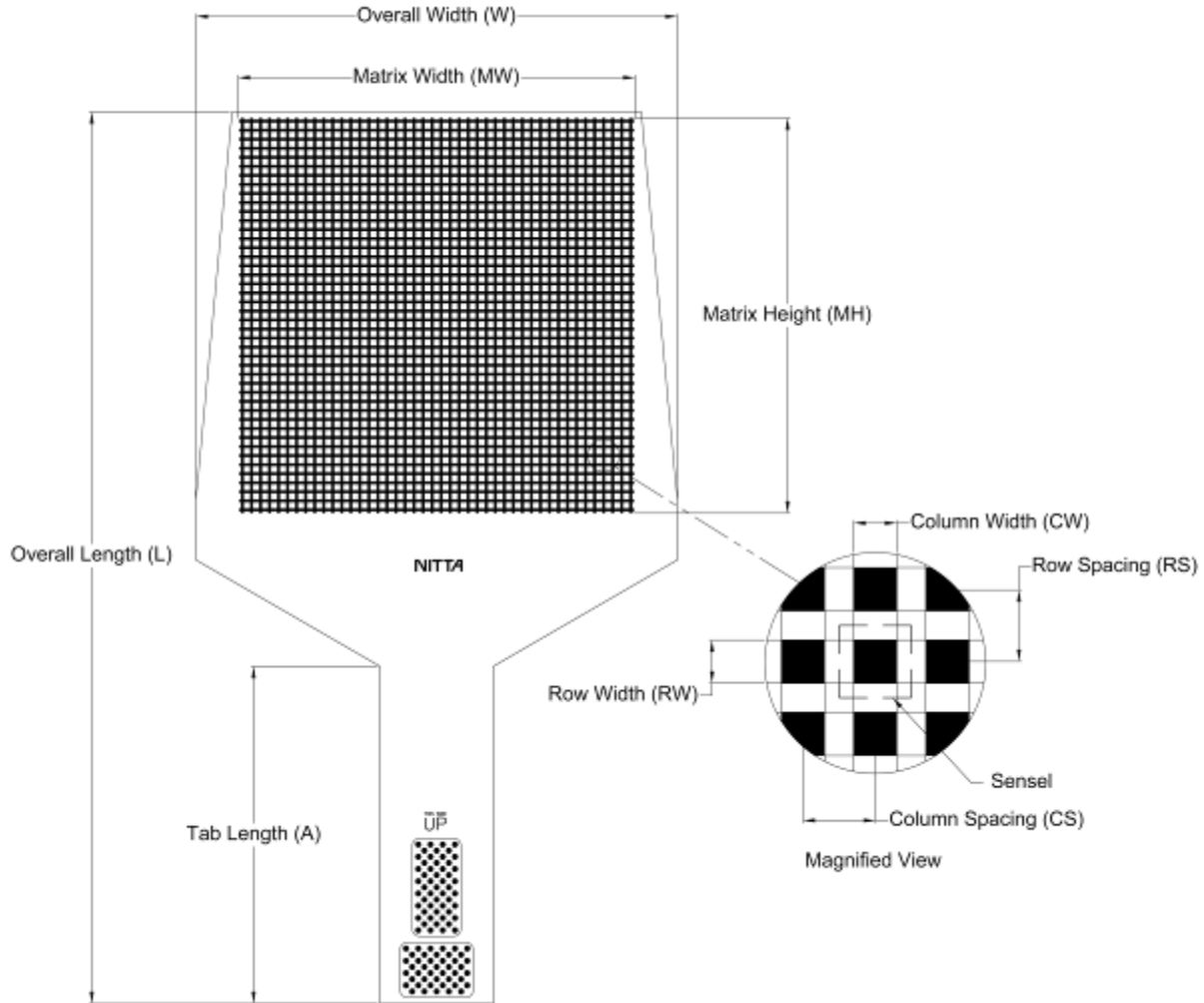

General Dimensions

Sensing Area Dimensions

Model	General Dimensions			Sensing Area Dimensions								Resolution	
	Overall Length (L)	Overall Width (W)	Tab Length (A)	Matrix Width (MW)	Matrix Height (MH)	Columns			Rows		Total No. of Sensels		Sensel Density
						CW	Pitch CS	Qty.	RW	Pitch RS		Qty.	
US	(in.)	(in.)	(in.)	(in.)	(in.)	(in.)	(in.)		(in.)	(in.)			(sensel per sq. in.)
5040N	14.57	3.05	11.57	1.73	1.73	0.020	0.039	44	0.020	0.039	44	1936	645.2
5150N	12.60	7.87	3.54	6.50	6.50	0.098	0.148	44	0.098	0.148	44	1936	45.9
5210N	21.26	11.18	7.87	9.35	9.35	0.118	0.213	44	0.118	0.213	44	1936	22.1
Metric	(mm)	(mm)	(mm)	(mm)	(mm)	(mm)	(mm)		(mm)	(mm)			(sensel per sq. cm)
5040N	370.0	77.5	294.0	44.0	44.0	0.5	1.0	44	0.5	1.0	44	1936	100.0
5150N	320.0	200.0	90.0	165.0	165.0	2.5	3.8	44	2.5	3.8	44	1936	7.1
5210N	540.0	284.0	200.0	237.6	237.6	3.0	5.4	44	3.0	5.4	44	1936	3.4

SENSOR MODEL: 5051/5076/5101

Application Example: Excellent for general purpose use

Features:

- Wide range of available pressures
- Internal vents

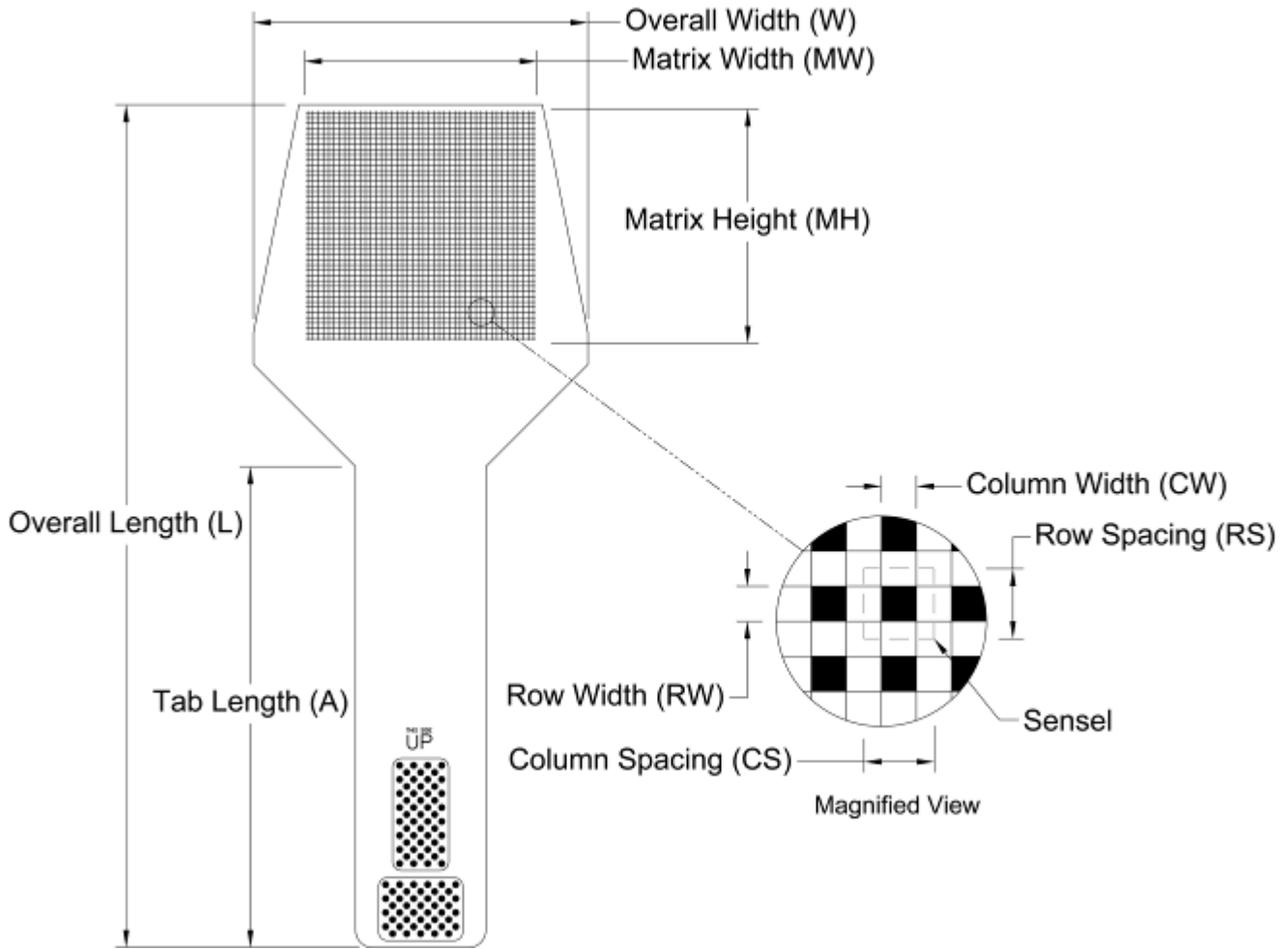

General Dimensions

Sensing Area Dimensions

Model	General Dimensions			Sensing Area Dimensions								Total No. of Sensels	Resolution Sensel Density
	Overall Length L	Overall Width W	Tab Length A	Matrix Width MW	Matrix Height MH	Columns			Rows				
	(in.)	(in.)	(in.)	(in.)	(in.)	CW	Pitch CS	Qty.	RW	Pitch RS	Qty.		(sensel per sq. in.)
US													
5051	9.94	3.20	6.54	2.20	2.20	0.030	0.050	44	0.030	0.050	44	1936	400.0
5076	12.03	4.78	6.93	3.30	3.30	0.040	0.075	44	0.040	0.075	44	1936	177.8
5101	13.39	5.86	6.59	4.40	4.40	0.050	0.100	44	0.050	0.100	44	1936	100.0
Metric	(mm)	(mm)	(mm)	(mm)	(mm)	(mm)	(mm)		(mm)	(mm)			(sensel per sq. cm)
5051	252.5	81.3	166.2	55.9	55.9	0.8	1.3	44	0.8	1.3	44	1936	62.0
5076	305.5	121.3	175.9	83.8	83.8	1.0	1.9	44	1.0	1.9	44	1936	27.6
5101	340.0	149.0	167.3	111.8	111.8	1.3	2.5	44	1.3	2.5	44	1936	15.5

SENSOR MODEL: 5250

Application Example: CMP machine and screen printing machine set up

Features:

- Trimmable from two sides
- External and Internal vents

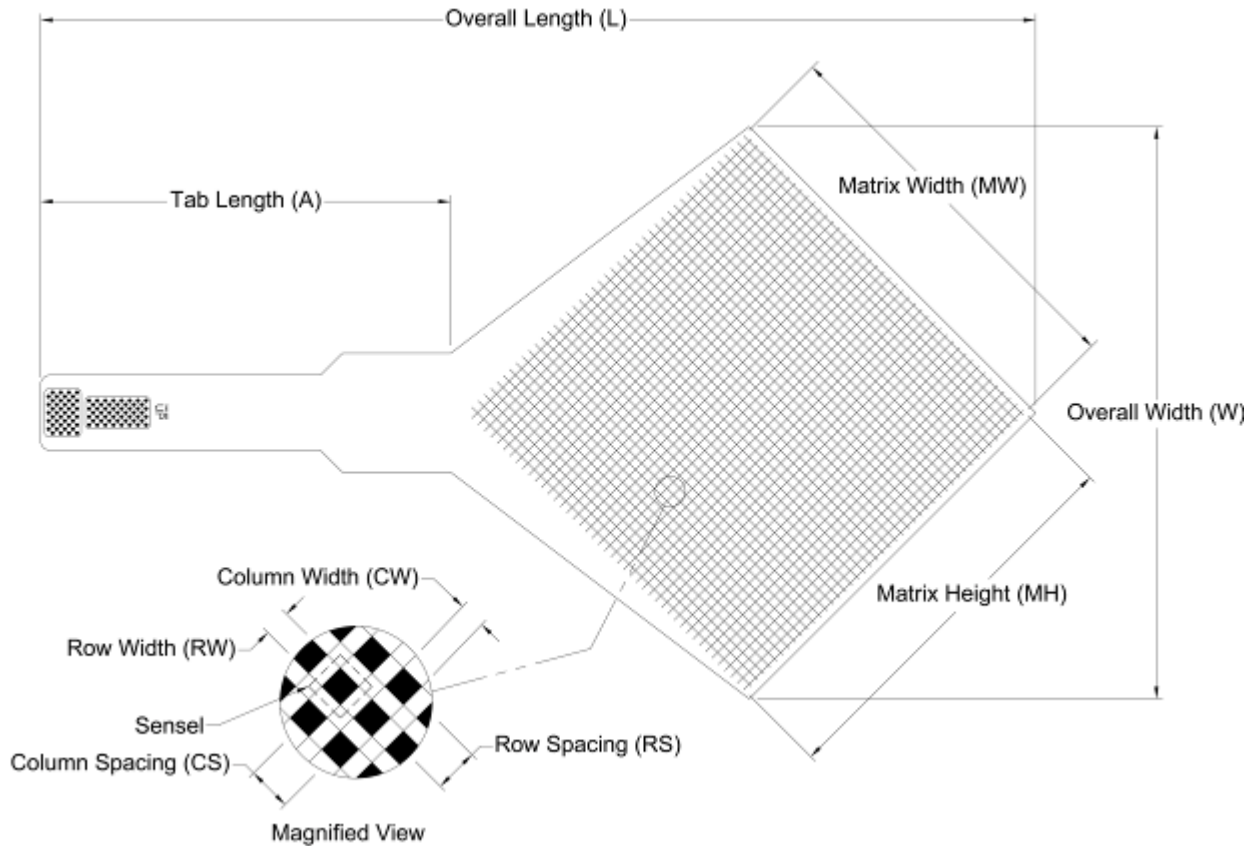

General Dimensions

Sensing Area Dimensions

Model	General Dimensions			Sensing Area Dimensions								Resolution	
	Overall Length L	Overall Width W	Tab Length A	Matrix Width MW	Matrix Height MH	Columns			Rows			Total No. of Sensels	Sensel Density
	(in.)	(in.)	(in.)	(in.)	(in.)	CW	Pitch CS	Qty.	RW	Pitch RS	Qty.		(sensel per sq. in.)
US 5250	24.51	14.11	10.00	9.68	9.68	0.130	0.220	44	0.130	0.220	44	1936	20.7
Metric 5250	622.6	358.3	254.0	245.9	245.9	3.3	5.6	44	3.3	5.6	44	1936	3.2

SENSOR MODEL: 5260

Application Example: Catalytic converter manufacturing

Features:

- Can be trimmed from two sides
- External and internal vents

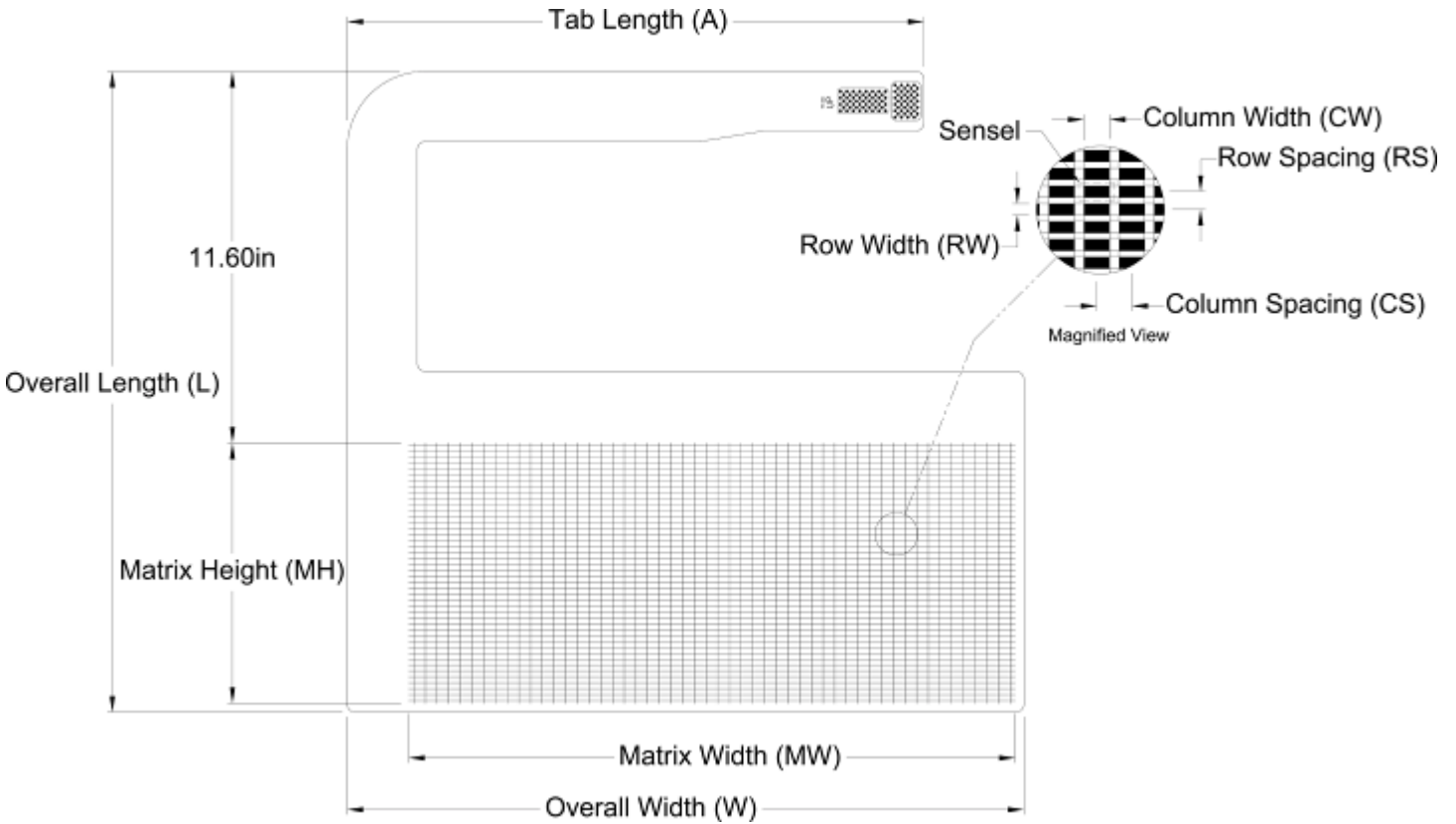

Model	General Dimensions			Sensing Area Dimensions								Total No.of Sensels	Resolution Sensel Density
	Overall Length L	Overall Width W	Tab Length A	Matrix Width MW	Matrix Height MH	Columns			Rows				
						CW	Pitch CS	Qty.	RW	Pitch RS	Qty.		
US 5260	(in.) 20.00	(in.) 21.13	(in.) 18.13	(in.) 18.98	(in.) 8.14	(in.) 0.265	(in.) 0.365	52	(in.) 0.120	(in.) 0.185	44	2288	(sensel per sq. in.) 14.8
Metric 5260	(mm) 508.0	(mm) 536.6	(mm) 460.4	(mm) 482.1	(mm) 206.8	(mm) 6.7	(mm) 9.3	52	(mm) 3.0	(mm) 4.7	44	2288	(sensel per sq. cm) 2.3

SENSOR MODEL: 5270

Application Example: Pressure distribution between large surfaces (stamping or molding)

Features:

- Wiring scheme enables sensors to be placed right next to each other on three sides
- Trimmable from the side opposite the tab
- External and internal vents

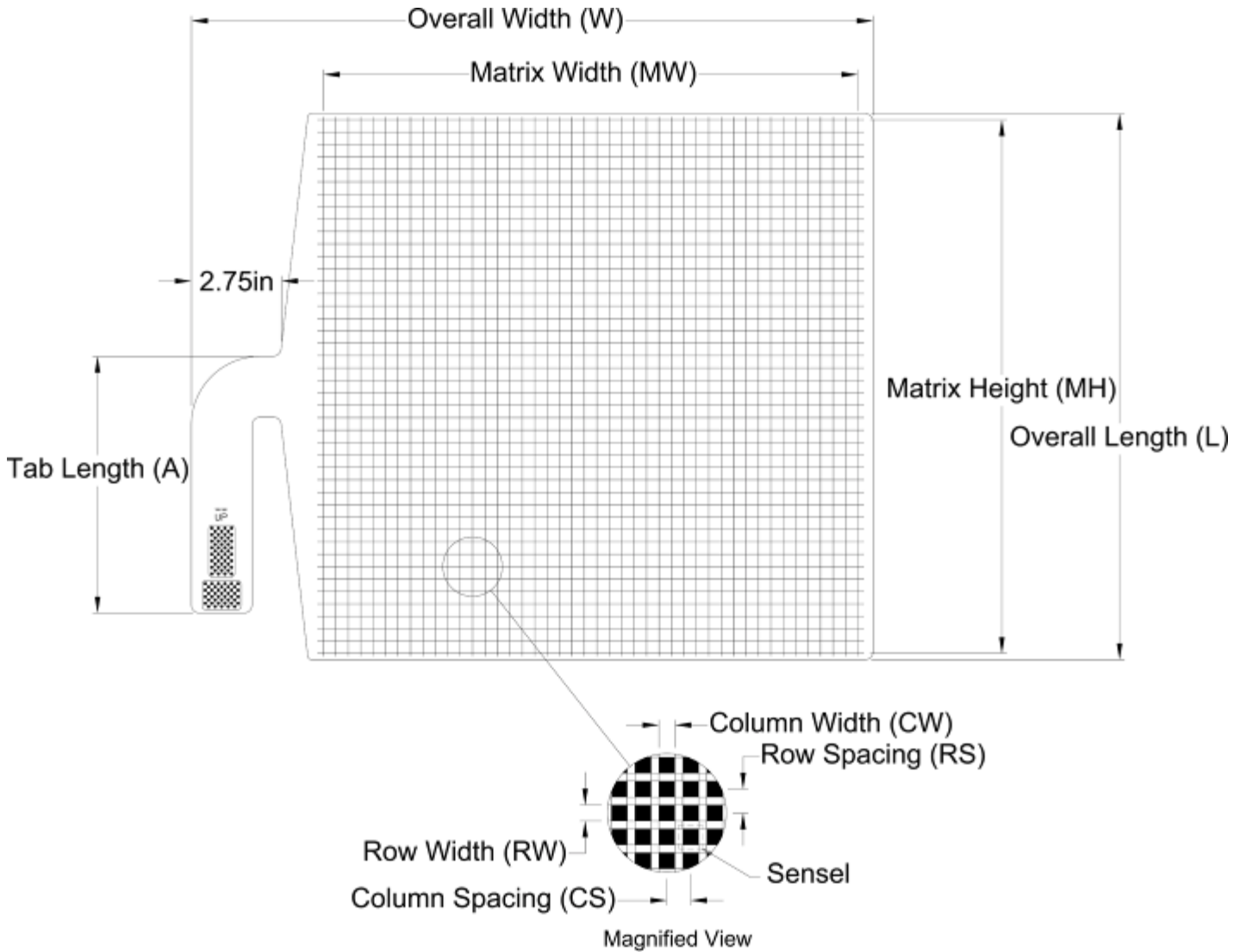

General Dimensions

Sensing Area Dimensions

Model	Overall Length L	Overall Width W	Tab Length A	Matrix Width MW	Matrix Height MH	Columns			Rows			Total No. of Sensels	Resolution Sensel Density
						CW	Pitch CS	Qty.	RW	Pitch RS	Qty.		
US 5270	(in.) 16.72	(in.) 20.85	(in.) 7.99	(in.) 16.72	(in.) 16.72	(in.) 0.140	(in.) 0.380	44	(in.) 0.260	(in.) 0.380	44	1936	(sensel per sq. in.) 6.9
Metric 5270	(mm) 424.7	(mm) 529.5	(mm) 202.8	(mm) 424.7	(mm) 424.7	(mm) 3.6	(mm) 9.7	44	(mm) 6.6	(mm) 9.7	44	1936	(sensel per sq. cm) 1.1

SENSOR MODEL: 5315/5350

Application Examples:

- Pressure mapping and comfort studies of seats, cushions and mattresses
- CMP, screen printing, and stamping press machine set up

Features:

- Sensor is covered with a flexible backing material to increase its durability
- Total thickness of 0.33mm (0.012") includes flexible backing on both sides of sensor; thinner construction may be available
- External vents

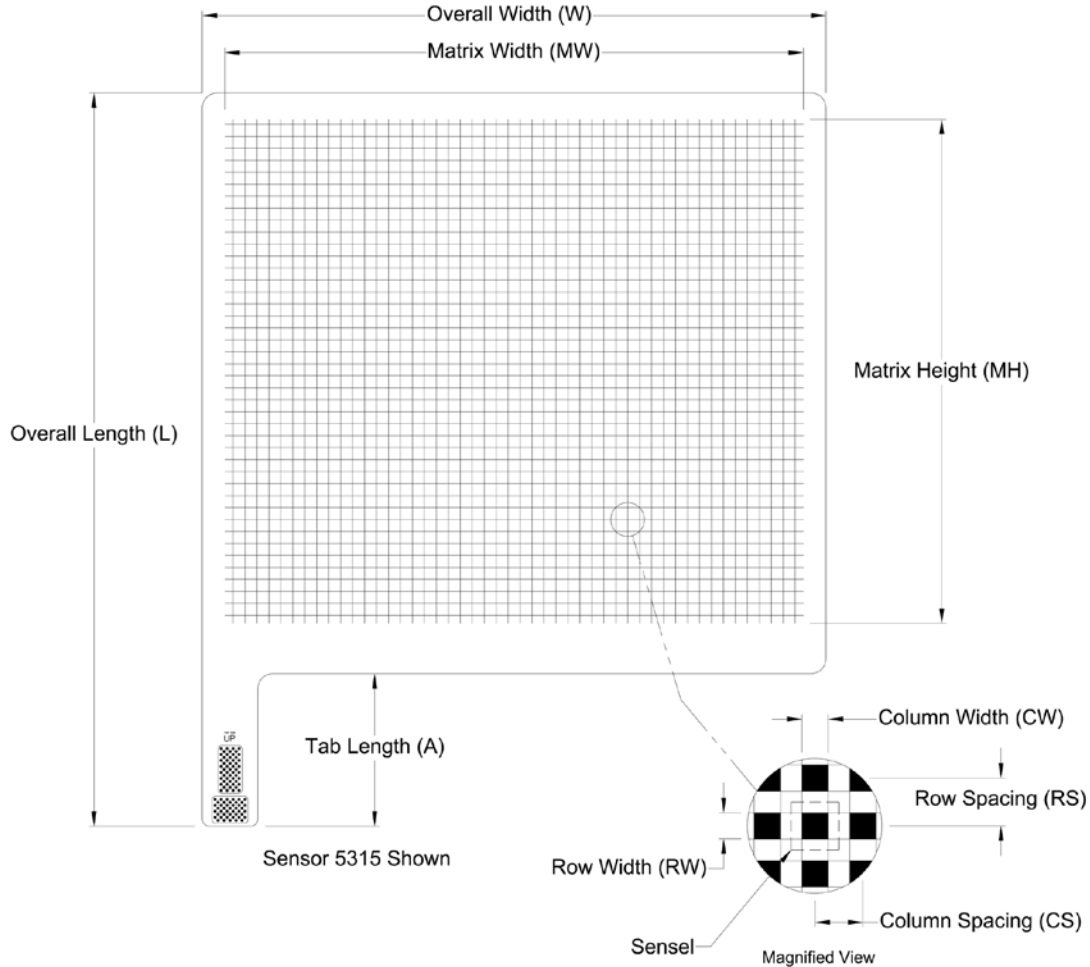

General Dimensions

Sensing Area Dimensions

Model	General Dimensions			Sensing Area Dimensions								Total No. of Sensels	Resolution Sensel Density
	Overall Length L	Overall Width W	Tab Length A	Matrix Width MW	Matrix Height MH	Columns			Rows				
	(in.)	(in.)	(in.)	(in.)	(in.)	CW	Pitch CS	Qty.	RW	Pitch RS	Qty.		(sensel per sq. in.)
US													
5315	24.50	20.86	5.15	19.20	16.80	0.250	0.400	48	0.250	0.400	42	2016	6.3
5350	24.00	18.06	6.61	16.40	15.20	0.250	0.400	41	0.250	0.400	38	1558	6.3
Metric	(mm)	(mm)	(mm)	(mm)	(mm)	(mm)	(mm)		(mm)	(mm)			(sensel per sq. cm)
5315	622.3	529.8	130.9	487.7	426.7	6.4	10.2	48	6.4	10.2	42	2016	1.0
5350	609.6	458.7	167.9	416.6	386.1	6.4	10.2	41	6.4	10.2	38	1558	1.0

SENSOR MODEL: 5320

Application Example: Crash dummy chests and abdomens, car bumper impacts

Features:

- High-speed sensing in crash tests
- External vents

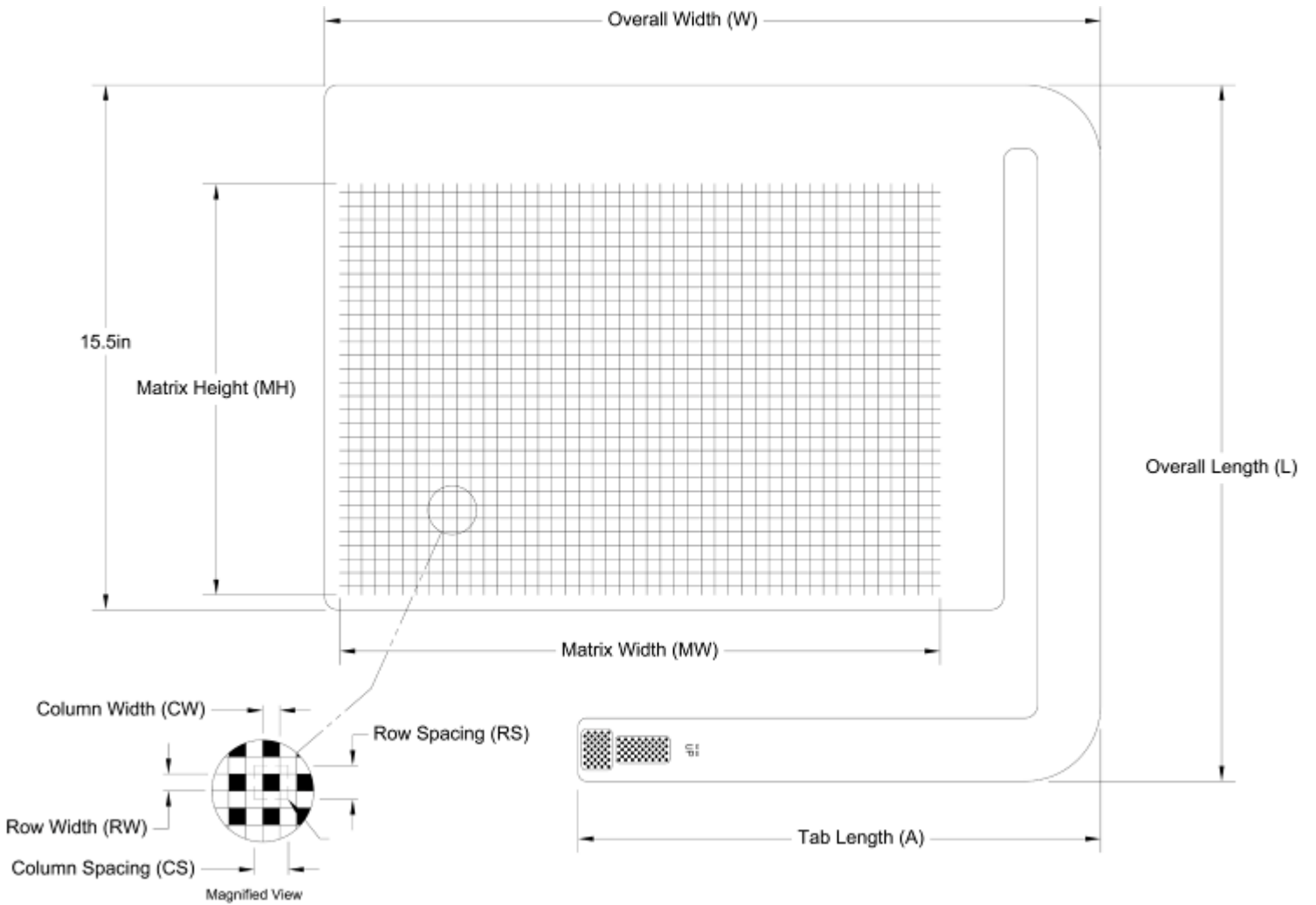

General Dimensions

Sensing Area Dimensions

Model	Overall Length L	Overall Width W	Tab Length A	Matrix Width MW	Matrix Height MH	Columns			Rows			Total No. of Sensels	Resolution Sensel Density
						CW	Pitch CS	Qty.	RW	Pitch RS	Qty.		
US 5320	(in.) 20.50	(in.) 22.86	(in.) 15.39	(in.) 17.60	(in.) 12.00	(in.) 0.250	(in.) 0.400	44	(in.) 0.250	(in.) 0.400	30	1320	(sensel per sq. in.) 6.3
Metric 5320	(mm) 520.7	(mm) 580.6	(mm) 391.0	(mm) 447.0	(mm) 304.8	(mm) 6.4	(mm) 10.2	44	(mm) 6.4	(mm) 10.2	30	1320	(sensel per sq. cm) 1.0

SENSOR MODEL: 5350N

Application Examples:

- Pressure mapping and comfort studies of seats, cushions and mattresses
- CMP, screen printing, and stamping press machine set up

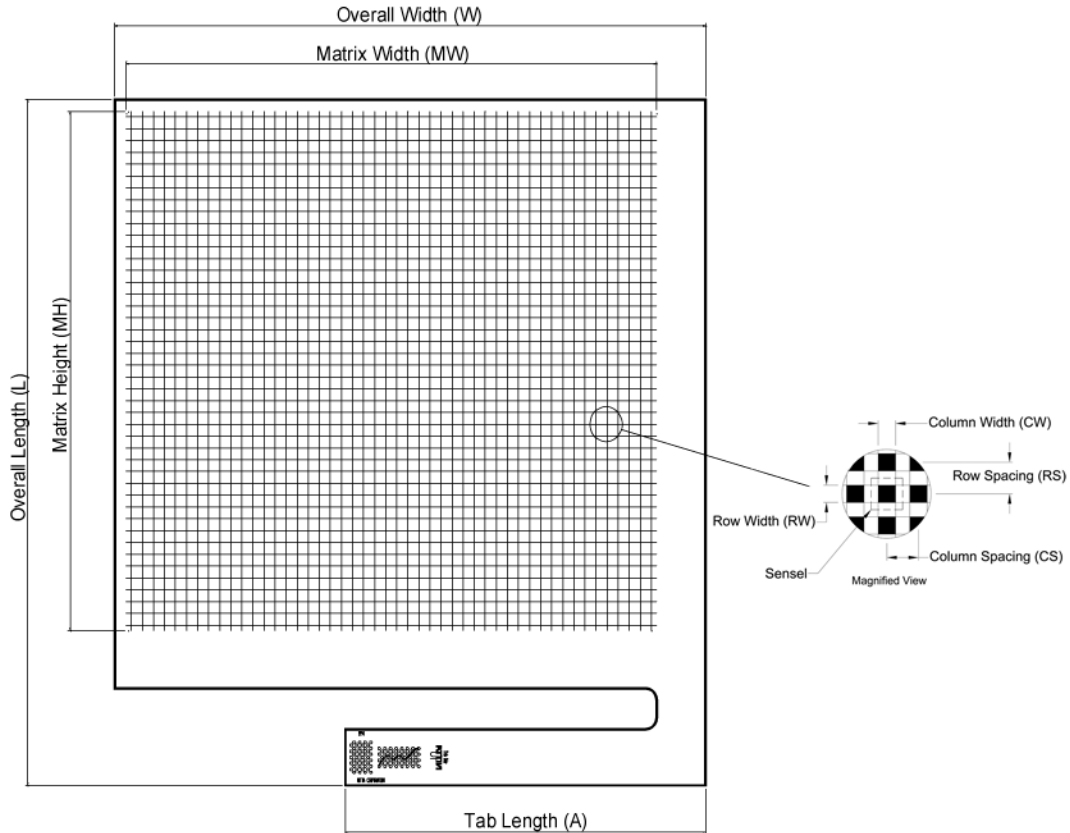

General Dimensions

Sensing Area Dimensions

Model	General Dimensions			Sensing Area Dimensions								Total No.of Sensels	Resolution Sensel Density
	Overall Length L	Overall Width W	Tab Length A	Matrix Width MW	Matrix Height MH	Columns			Rows				
						CW	Pitch CS	Qty.	RW	Pitch RS	Qty.		
US 5350N	(in.) 22.83	(in.) 21.02	(in.) 12.8	(in.) 17.32	(in.) 18.90	(in.) 0.236	(in.) 0.394	44	(in.) 0.236	(in.) 0.394	48	2112	(sensel per sq. in.) 6.5
Metric 5350N	(mm) 580.0	(mm) 534.0	(mm) 325.0	(mm) 440.0	(mm) 480.0	(mm) 6.0	(mm) 10.0	44	(mm) 6.0	(mm) 10.0	48	2112	(sensel per sq. cm) 1.0

SENSOR MODEL: 5330

SENSOR NAME: *CONFORMAT*[®]

Application Example: Pressure mapping and comfort studies of seats and cushions

Features:

- Fully conforming sensor, sensor elements move freely in the X, Y, and Z axis
- Minimal interference with the client/support surface interface

Requirement: *CONFORMat* or *BPMS*[™] software

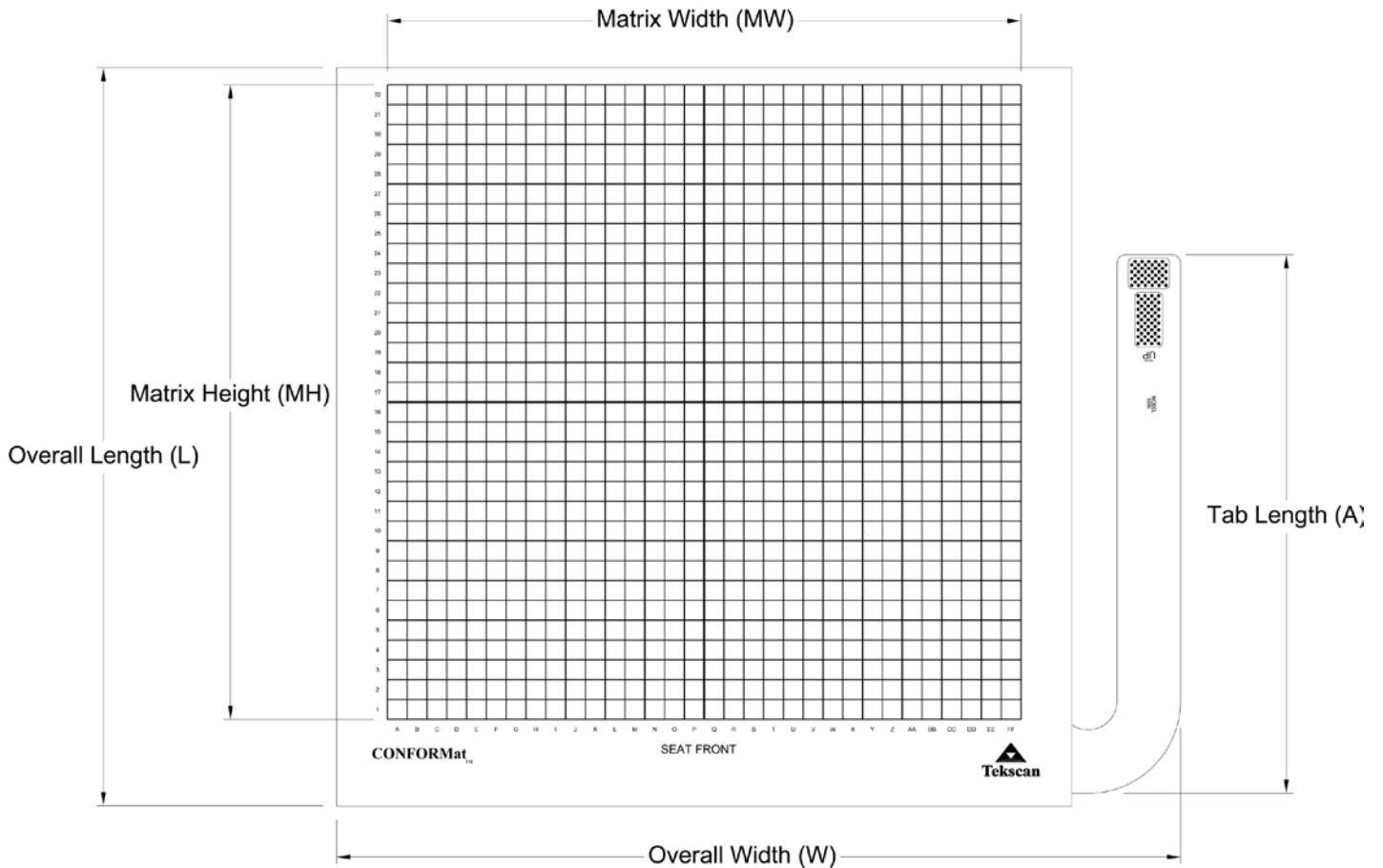

General Dimensions

Sensing Area Dimensions

Model	General Dimensions			Sensing Area Dimensions								Total No. of Sensels	Resolution Sensel Density
	Overall Length L	Overall Width W	Tab Length A	Matrix Width MW	Matrix Height MH	Columns			Rows				
	(in.)	(in.)	(in.)	(in.)	(in.)	CW	Pitch CS	Qty.	RW	Pitch RS	Qty.		(sensel per sq. in.)
US 5330	21.23	24.35	15.76	18.56	18.56	0.000	0.580	32	0.000	0.580	32	1024	3.0
Metric 5330	(mm)	(mm)	(mm)	(mm)	(mm)	(mm)	(mm)		(mm)	(mm)			(sensel per sq. cm)
	539.2	618.4	400.3	471.4	471.4	0.0	14.7	32	0.0	14.7	32	1024	0.5

SENSOR MODEL: 5400N

SENSOR NAME: *HUGE-MAT*TM

Application Example: Ergonomic and comfort studies of seats, cushions and mattresses

Features:

- Sensor is covered with a flexible backing material to increase its durability; total thickness of 0.33mm (0.012") includes flexible backing on both sides of sensor; thinner construction may be available
- Also available with protective platform for foot and hoof applications

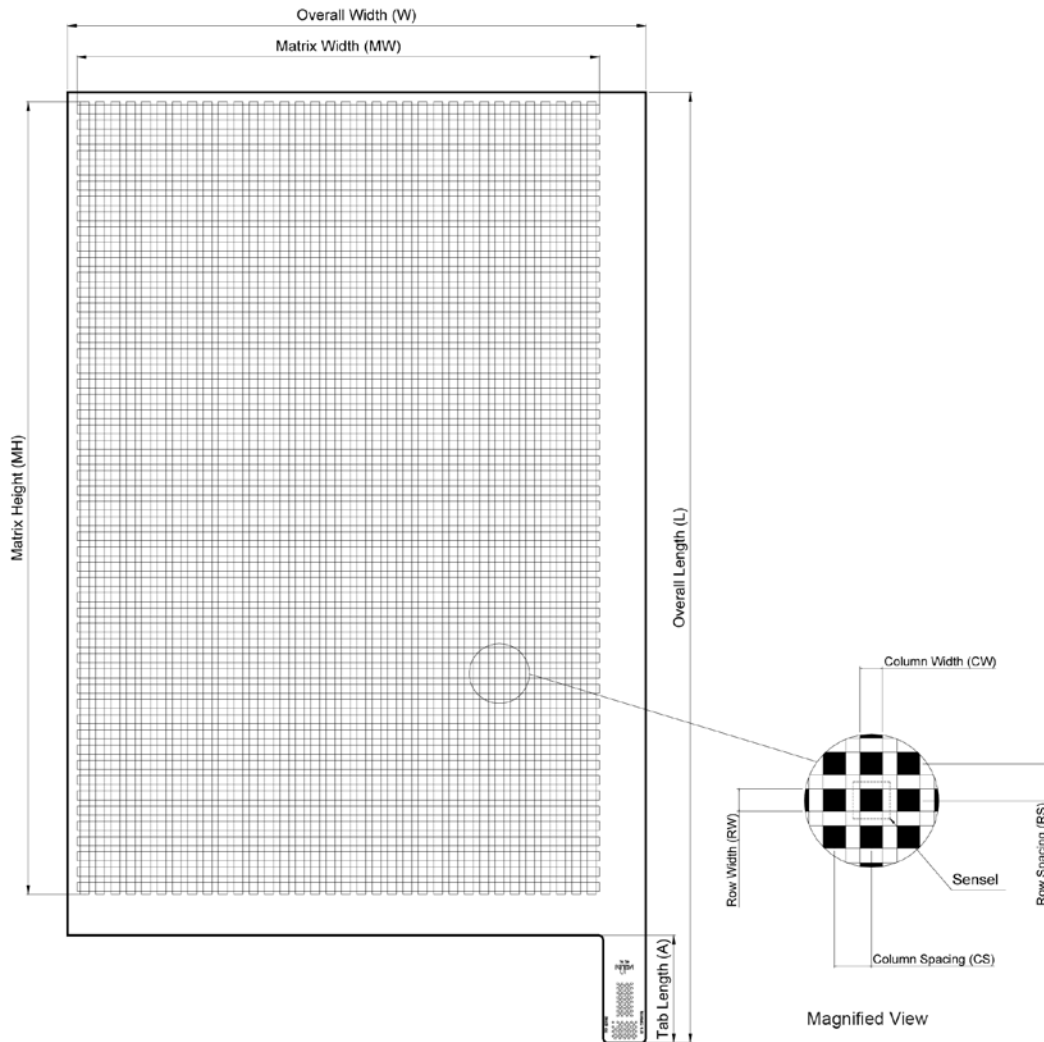

Model	General Dimensions					Sensing Area Dimensions						Total No. of Sensels	Resolution Sensel Density
	Overall Length L	Overall Width W	Tab Length A	Matrix Width MW	Matrix Height MH	Columns			Rows				
						CW	Pitch CS	Qty.	RW	Pitch RS	Qty.		
US	(in.)	(in.)	(in.)	(in.)	(in.)	(in.)	(in.)		(in.)	(in.)			(sensel per sq. in.)
5350N	22.83	21.02	12.8	17.32	18.90	0.236	0.394	44	0.236	0.394	48	2112	6.5
Metric	(mm)	(mm)	(mm)	(mm)	(mm)	(mm)	(mm)		(mm)	(mm)			(sensel per sq. cm)

SENSOR MODEL: 5501/5570

Application Examples:

- Nip roller pressure in personal printers, copiers and fax machines
- Nip roller pressure in paper and textile mills

Features:

- Excellent for line contacts
- External vents 5501 / Internal vents 5570

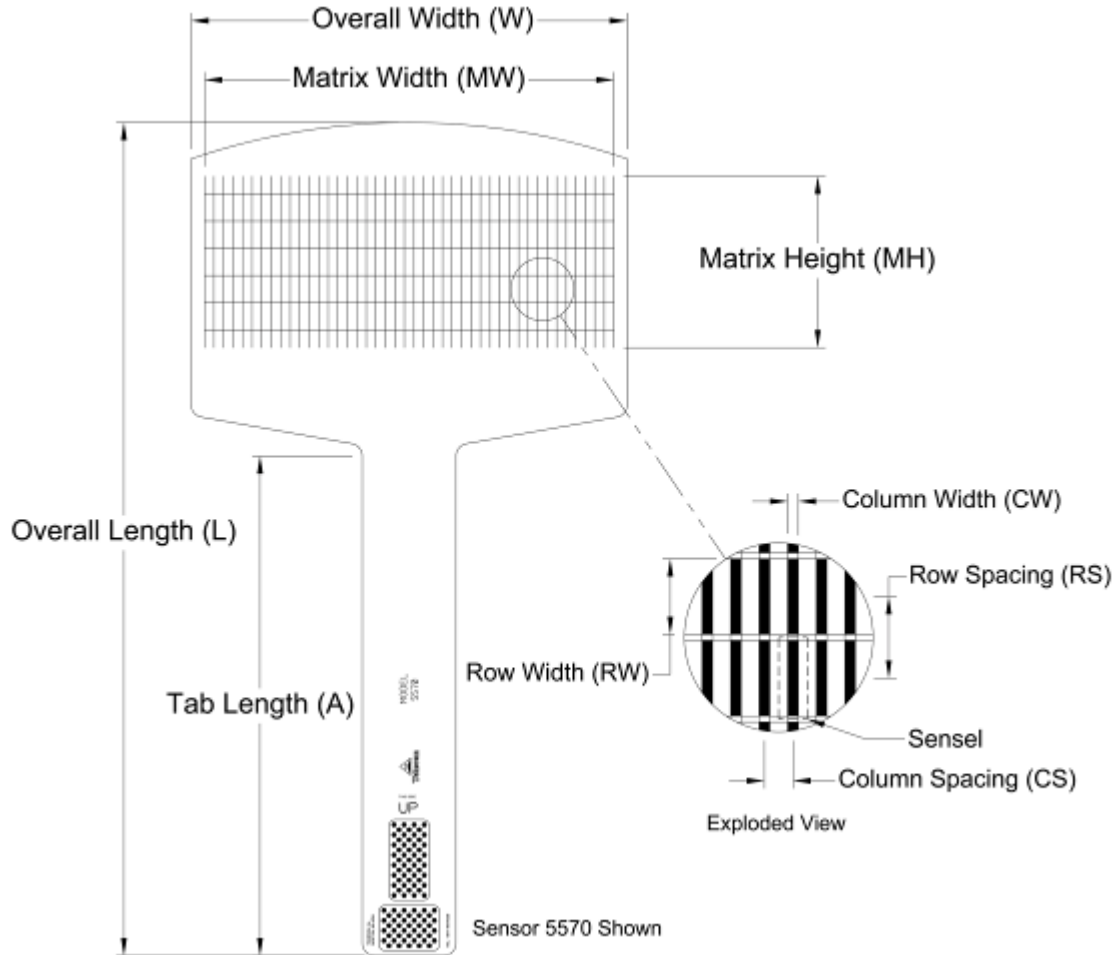

General Dimensions

Sensing Area Dimensions

Model	General Dimensions			Sensing Area Dimensions								Total No. of Sensels	Resolution Sensel Density
	Overall Length L	Overall Width W	Tab Length A	Matrix Width MW	Matrix Height MH	Columns			Rows				
	(in.)	(in.)	(in.)	(in.)	(in.)	CW	Pitch CS	Qty.	RW	Pitch RS	Qty.		(sensel per sq. in.)
US						(in.)	(in.)		(in.)	(in.)			
5501	17.24	12.27	9.63	12.03	3.24	0.070	0.274	44	0.500	0.540	6	264	6.8
5570	16.54	8.66	9.92	8.36	3.24	0.070	0.190	44	0.500	0.540	6	264	9.7
Metric	(mm)	(mm)	(mm)	(mm)	(mm)	(mm)	(mm)		(mm)	(mm)			(sensel per sq. cm)
5501	437.8	311.6	244.7	305.7	82.3	1.8	6.9	44	12.7	13.7	6	264	1.0
5570	420.1	220.0	251.9	212.3	82.3	1.8	4.8	44	12.7	13.7	6	264	1.5

307 West First St., South Boston, MA 02127

Tel: 617.464.4500/800.248.3669 fax: 617.464.4266 web: www.tekscan.com

SENSOR MODEL: 5510/5511

Application Example:

- Paper machine shoe presses
- Brake shoes

Features:

- Long handle
- Sensor is manufactured on a thicker substrate to enhance durability
- Total thickness in sensing region is 0.30 mm (0.012"); thinner construction may be available
- Internal vent

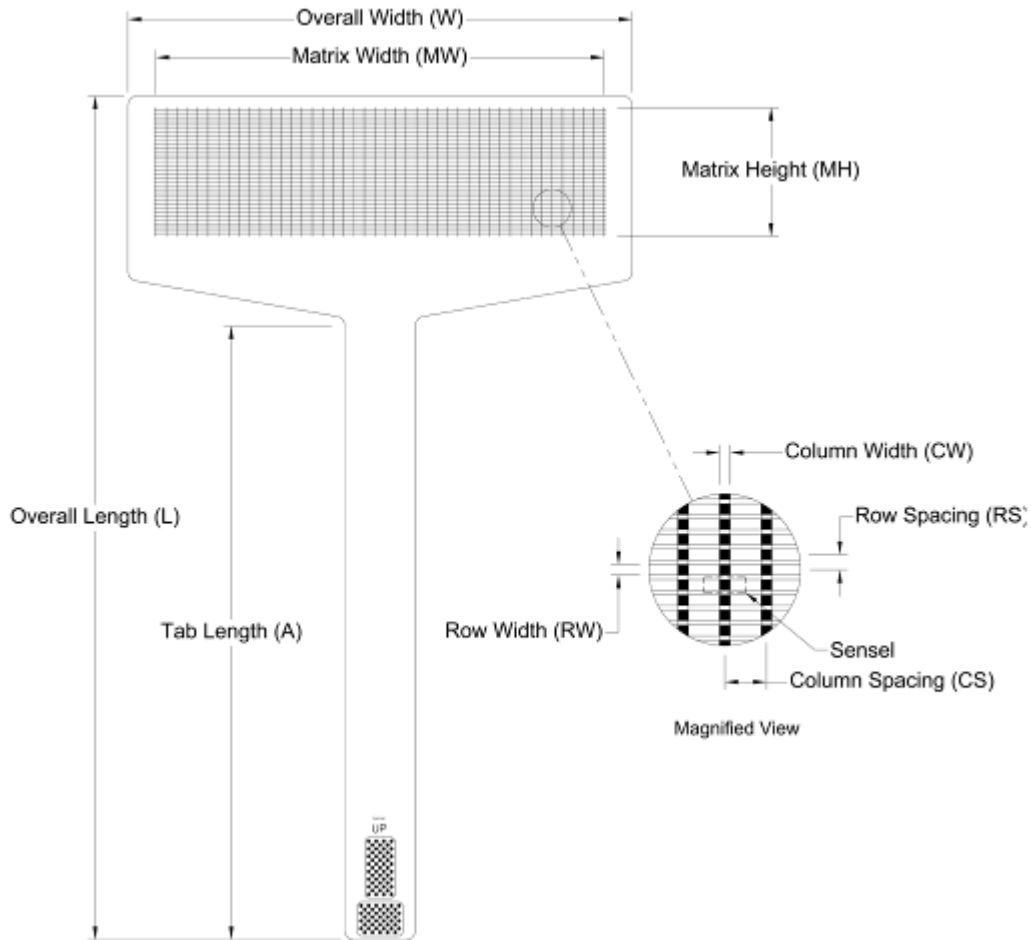

General Dimensions

Sensing Area Dimensions

Model	General Dimensions			Sensing Area Dimensions								Total No. of Sensels	Resolution Sensel Density
	Overall Length L	Overall Width W	Tab Length A	Matrix Width MW	Matrix Height MH	Columns			Rows				
	(in.)	(in.)	(in.)	(in.)	(in.)	CW	Pitch CS	Qty.	RW	Pitch RS	Qty.		(sensel per sq. in.)
US													
5510	12.30	13.30	5.10	12.14	3.40	0.070	0.276	44	0.070	0.100	34	1496	36.2
5511	22.25	13.30	16.19	12.10	3.40	0.070	0.275	44	0.070	0.100	34	1496	36.4
Metric	(mm)	(mm)	(mm)	(mm)	(mm)	(mm)	(mm)		(mm)	(mm)			(sensel per sq. cm)
5510	312.4	337.8	129.5	308.5	86.4	1.8	7.0	44	1.8	2.5	34	1496	5.6
5511	565.2	337.8	411.2	307.3	86.4	1.8	7.0	44	1.8	2.5	34	1496	5.6

307 West First St., South Boston, MA 02127

Tel: 617.464.4500/800.248.3669 fax: 617.464.4266 web: www.tekscan.com

SENSOR MODEL: 5513

Application Examples: Paper machine shoe press and nip rollers

Features:

- Sensor is manufactured on a thicker substrate to enhance durability
- Total thickness in sensing region is 0.30 mm (0.012"); thinner construction may be available
- Internal vent

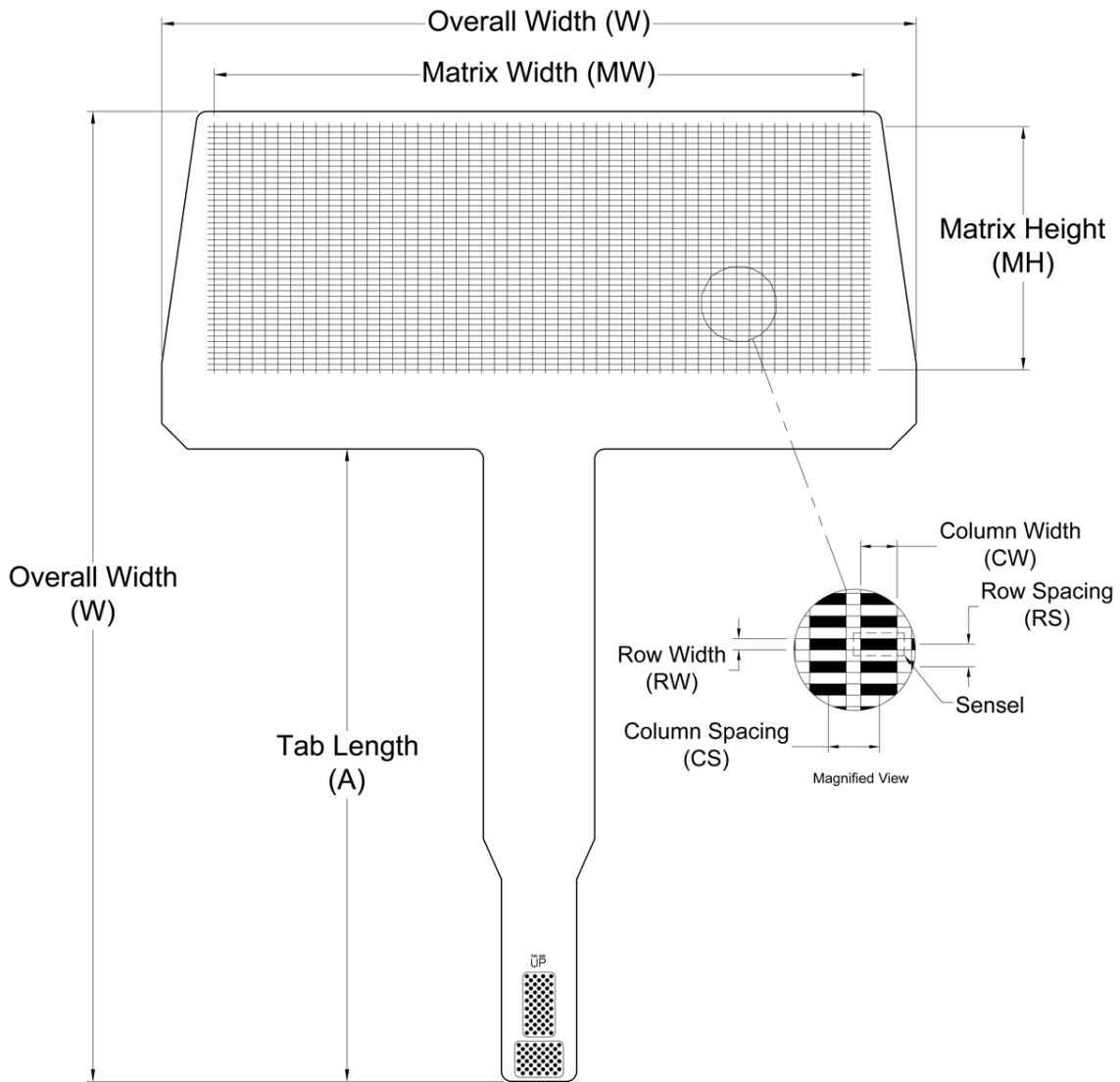

General Dimensions

Sensing Area Dimensions

Model	General Dimensions			Sensing Area Dimensions								Resolution	
	Overall Length L	Overall Width W	Tab Length A	Matrix Width MW	Matrix Height MH	Columns			Rows		Total No. of Sensels	Sensel Density	
	(in.)	(in.)	(in.)	(in.)	(in.)	CW	Pitch CS	Qty.	RW	Pitch RS			Qty.
US 5513	24.00	18.66	15.65	16.38	6.16	0.225	0.315	52	0.070	0.140	44	2288	22.7
Metric 5513	609.6	474.0	397.5	416.1	156.5	5.7	8.0	52	1.78	3.6	44	2288	3.5

SENSOR MODEL: 5515

Application Examples: Paper machine shoe press and nip rollers

Features:

- Can be inserted from the side of a pinch or nip roller
- Sensor is manufactured on a thicker substrate to enhance durability
- Total thickness in sensing region is 0.30 mm (0.012"); thinner construction may be available
- Internal vent

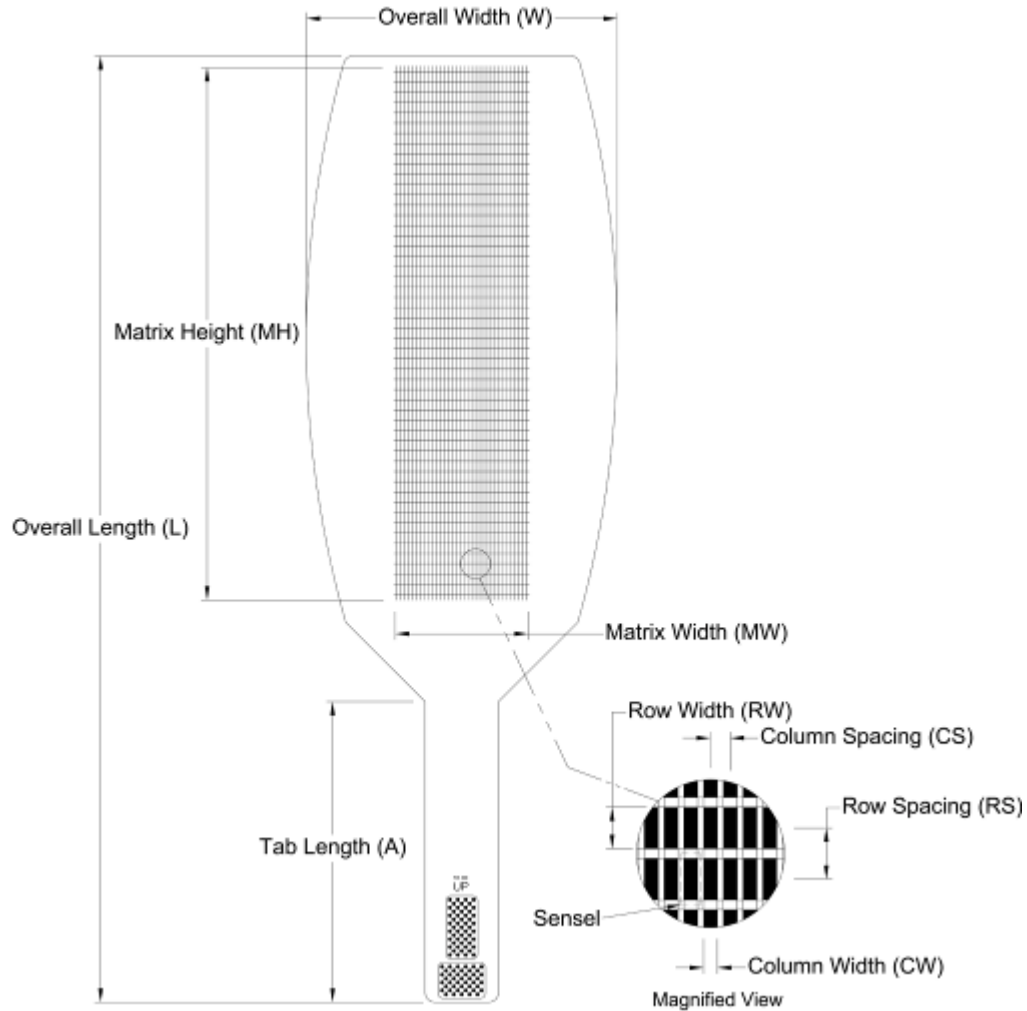

General Dimensions

Sensing Area Dimensions

Model	General Dimensions			Sensing Area Dimensions								Total No. of Sensels	Resolution Sensel Density
	Overall Length L	Overall Width W	Tab Length A	Matrix Width MW	Matrix Height MH	Columns			Rows				
	(in.)	(in.)	(in.)	(in.)	(in.)	CW	Pitch CS	Qty.	RW	Pitch RS	Qty.		(sensel per sq. in.)
US 5515	24.00	7.80	7.62	3.40	13.52	0.070	0.100	34	0.210	0.260	52	1768	38.5
Metric 5515	(mm)	(mm)	(mm)	(mm)	(mm)	(mm)	(mm)		(mm)	(mm)			(sensel per sq. cm)
	609.6	198.1	193.6	86.4	343.4	1.8	2.5	34	5.33	6.6	52	1768	6.0

SENSOR MODEL: 5526

Application Examples:

- Doctor blades in paper machines
- Narrow nip profiling

Features:

- Fine pitch for measuring nip widths
- Internal vents

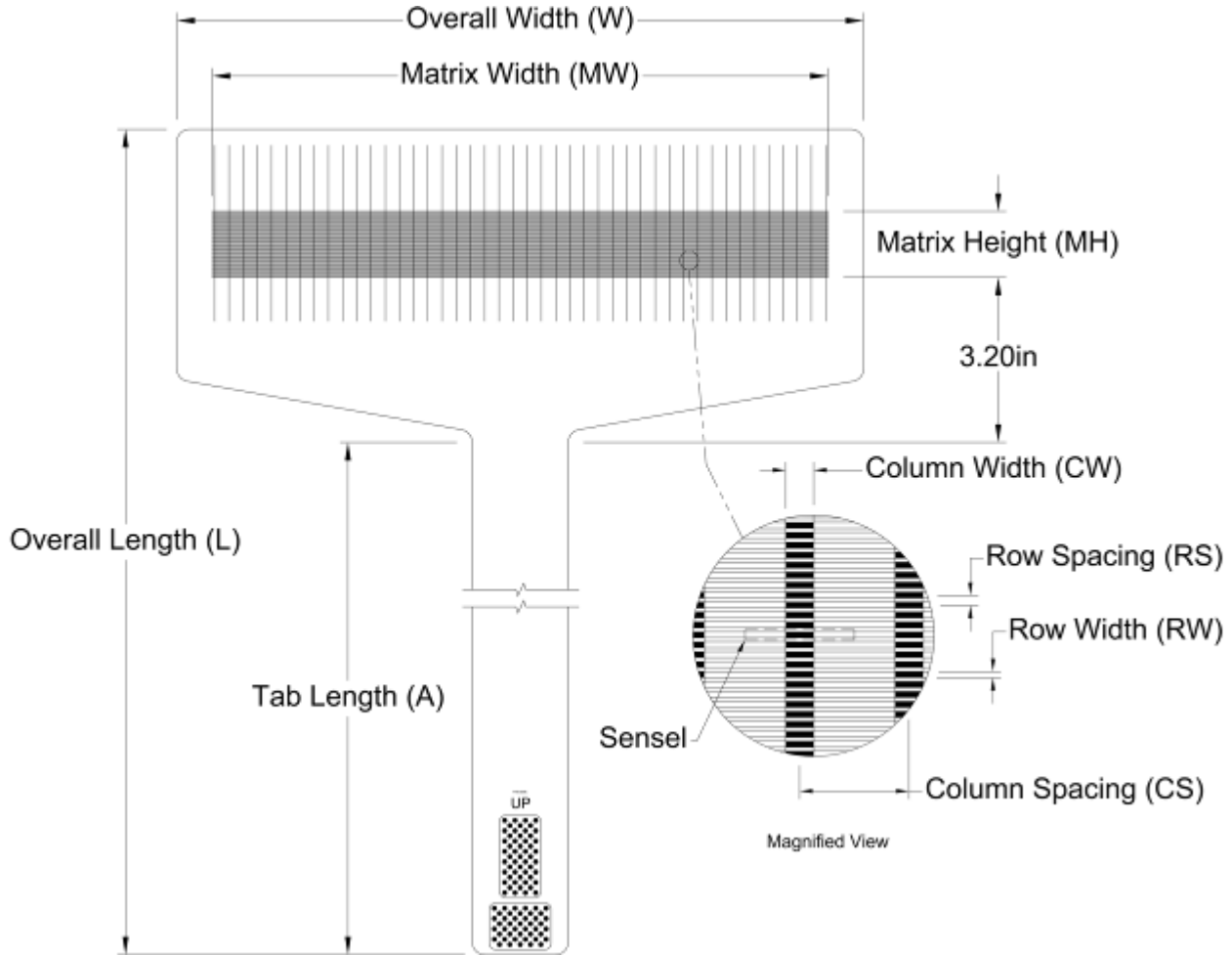

General Dimensions

Sensing Area Dimensions

Model	General Dimensions			Sensing Area Dimensions								Resolution Sensel Density	
	Overall Length L	Overall Width W	Tab Length A	Matrix Width MW	Matrix Height MH	Columns			Rows		Total No. of Sensels		
	(in.)	(in.)	(in.)	(in.)	(in.)	CW	Pitch CS	Qty.	RW	Pitch RS		Qty.	
US 5526	22.25	13.30	16.19	12.10	1.30	0.070	0.275	44	0.015	0.025	52	2288	(sensel per sq. in.) 145.5
Metric 5526	565.2	337.8	411.2	307.3	33.0	1.8	7.0	44	0.4	0.6	52	2288	(sensel per sq. cm) 22.5

SENSOR MODEL: 5550

Application Examples: ATM machine rollers, money change machine rollers, printer rollers, credit card laminators

Features:

- Fine pitch for nip width
- No vents

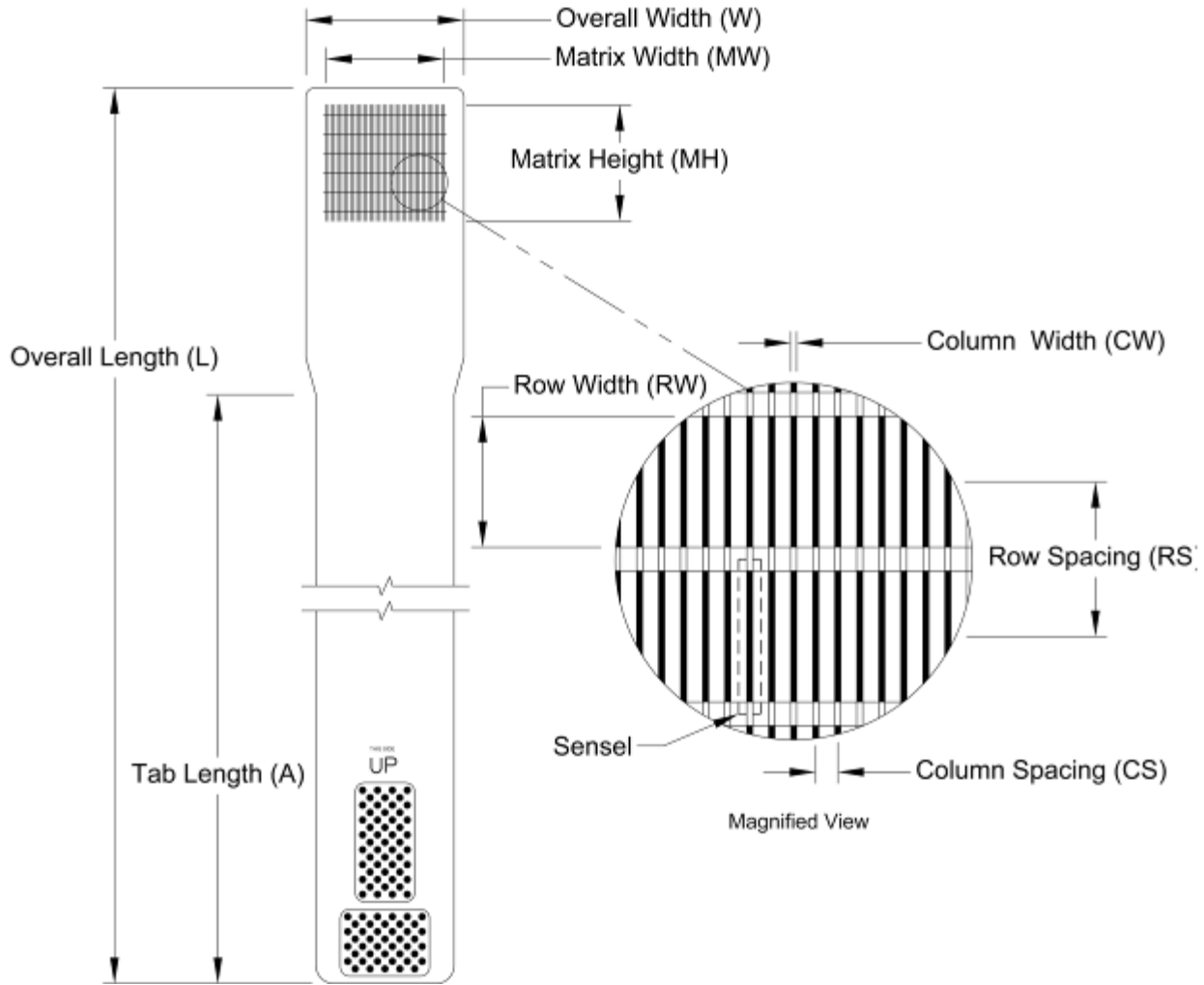

General Dimensions

Sensing Area Dimensions

Model	General Dimensions			Sensing Area Dimensions								Resolution	
	Overall Length L	Overall Width W	Tab Length A	Matrix Width MW	Matrix Height MH	Columns			Rows		Total No. of Sensels	Sensel Density	
						CW	Pitch CS	Qty.	RW	Pitch RS			Qty.
US 5550	(in.) 14.96	(in.) 2.13	(in.) 10.74	(in.) 1.66	(in.) 1.56	(in.) 0.010	(in.) 0.038	44	(in.) 0.220	(in.) 0.260	6	264	(sensel per sq. in.) 102.0
Metric 5550	(mm) 380.0	(mm) 54.0	(mm) 272.8	(mm) 42.1	(mm) 39.6	(mm) 0.3	(mm) 1.0	44	(mm) 5.6	(mm) 6.6	6	264	(sensel per sq. cm) 15.8

SENSOR MODEL: 5555

Application Example: Large nip rollers

Features: Internal vent

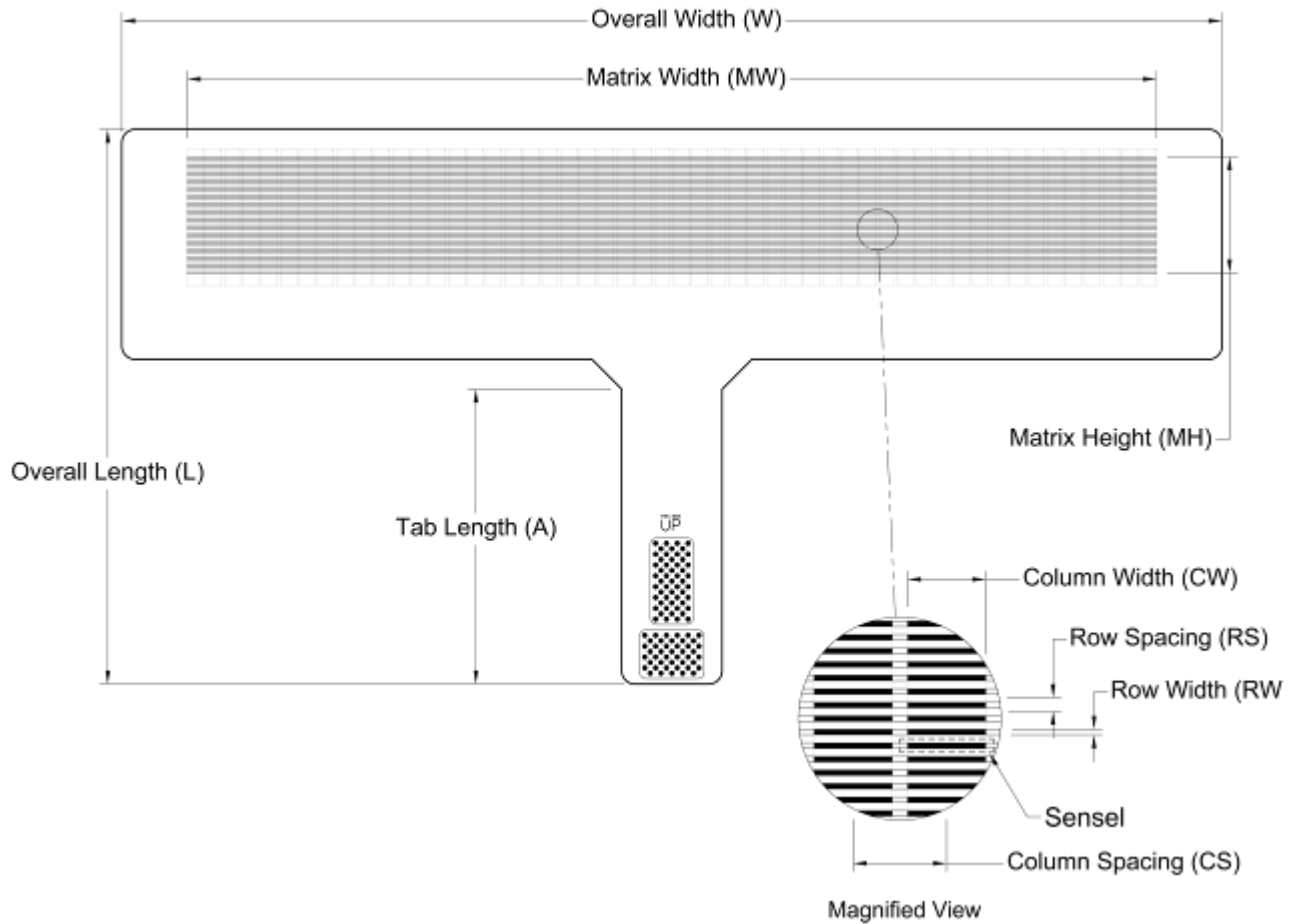

General Dimensions

Sensing Area Dimensions

Model	General Dimensions			Sensing Area Dimensions								Resolution	
	Overall Length L	Overall Width W	Tab Length A	Matrix Width MW	Matrix Height MH	Columns			Rows			Total No. of Sensels	Sensel Density
	(in.)	(in.)	(in.)	(in.)	(in.)	CW	Pitch CS	Qty.	RW	Pitch RS	Qty.		(sensel per sq. in.)
US 5555	10.25	20.36	5.53	17.99	2.20	0.290	0.346	52	0.020	0.050	44	2288	57.8
Metric 5555	(mm)	(mm)	(mm)	(mm)	(mm)	(mm)	(mm)		(mm)	(mm)			(sensel per sq. cm)
	260.3	517.1	140.4	457.0	55.9	7.4	8.8	52	0.5	1.3	44	2288	9.0

SENSOR MODEL: 5612N

Application Example: Rollers and nips

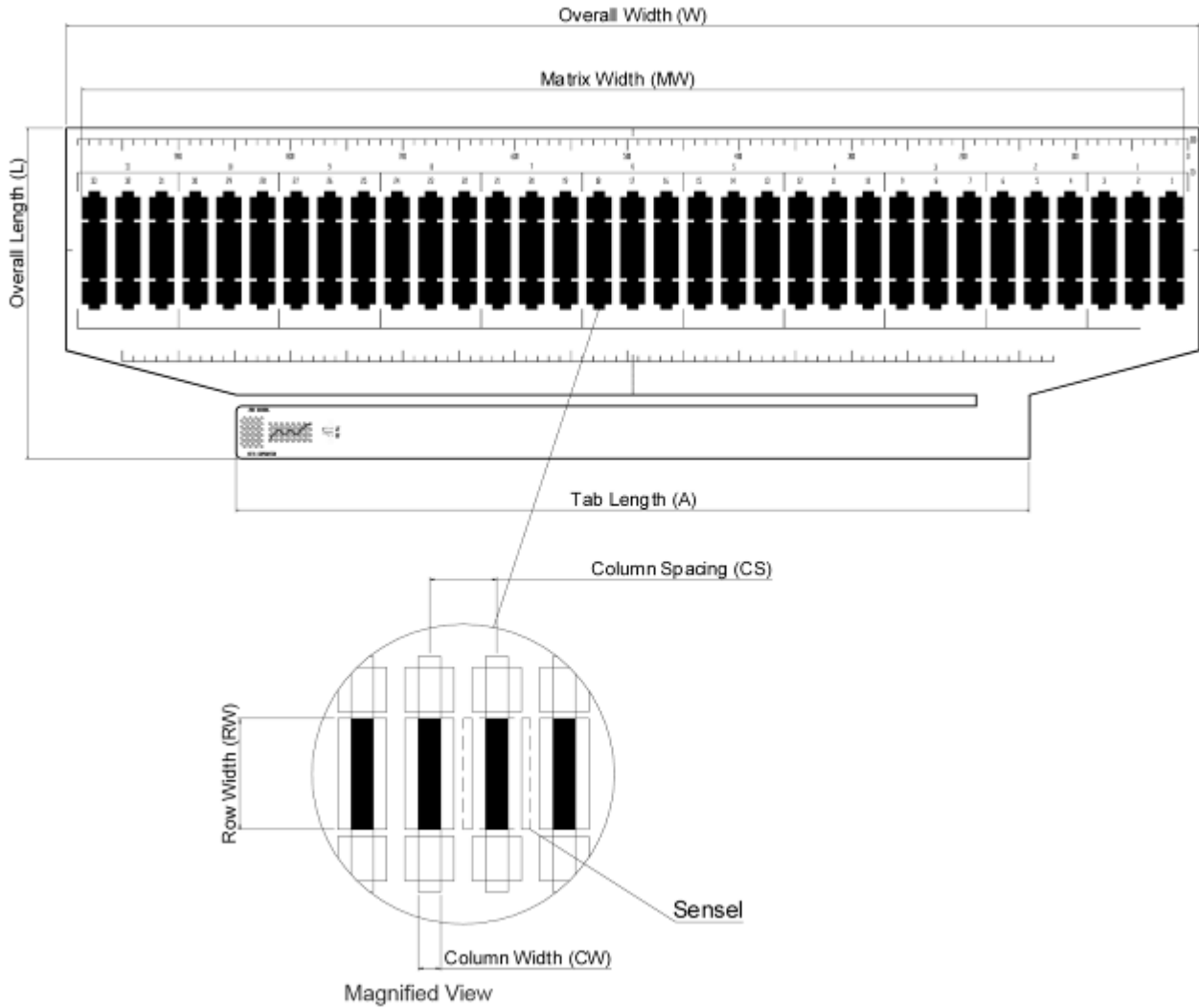

General Dimensions

Sensing Area Dimensions

Model	General Dimensions			Sensing Area Dimensions								Resolution	
	Overall Length	Overall Width	Tab Length	Matrix Width	Matrix Height	Columns			Rows		Total No.of Sensels		Sensel Density
	L	W	A	MW	MH	CW	Pitch	Qty.	RW	RS			
US	(in.)	(in.)	(in.)	(in.)	(in.)	(in.)	(in.)		(in.)	(in.)			(sensel per sq. in.)
5611N	11.69	39.76	27.83	38.98	1.97	0.394	1.181	33	1.969	0.000	1	33	0.4
Metric	(mm)	(mm)	(mm)	(mm)	(mm)	(mm)	(mm)		(mm)	(mm)			(sensel per sq. cm)

SENSOR MODEL: 5620N/5630N

Application Example: A3/A4 paper nips

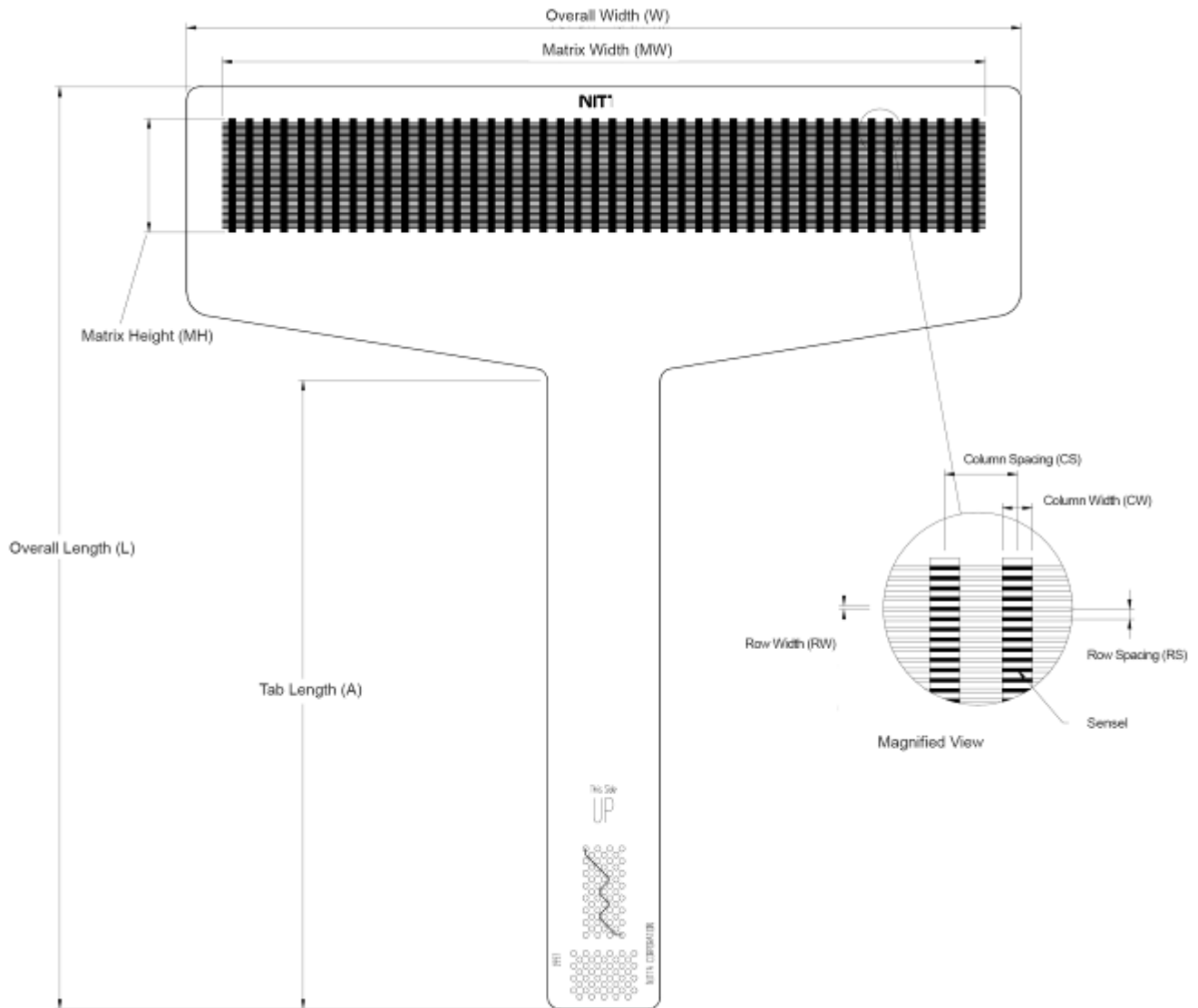

Model	L	W	A	MW	MH	CW	CS	Qty.	RW	RS	Qty.	Sensels	Sensel Density
US	(in.)	(in.)	(in.)	(in.)	(in.)	(in.)	(in.)		(in.)	(in.)			(sensel per sq. in.)
5617N	14.96	7.09	11.42	6.50	1.39	0.030	0.197	33	0.500	0.697	1	33	7.3
5632N	19.69	13.39	16.14	12.47	1.39	0.079	0.378	33	0.500	0.697	1	33	3.8
5660N	19.80	24.49	14.96	22.76	0.50	0.079	0.709	33	0.500	0.697	1	33	2.0
Metric	(mm)	(mm)	(mm)	(mm)	(mm)	(mm)	(mm)		(mm)	(mm)			(sensel per sq. cm)
5617N	380.0	180.0	290.0	165.0	35.4	0.8	5.0	33	12.7	17.7	1	66	1.1
5632N	500.0	340.0	410.0	316.8	35.4	2.0	9.6	33	12.7	17.7	1	66	0.6
5660N	503.0	622.0	380.0	578.0	12.7	2.0	18.0	33	12.7	17.7	1	66	0.3

SENSOR MODEL: 5800/5800N

Application Example: Small contact patches

Features: Internal vent

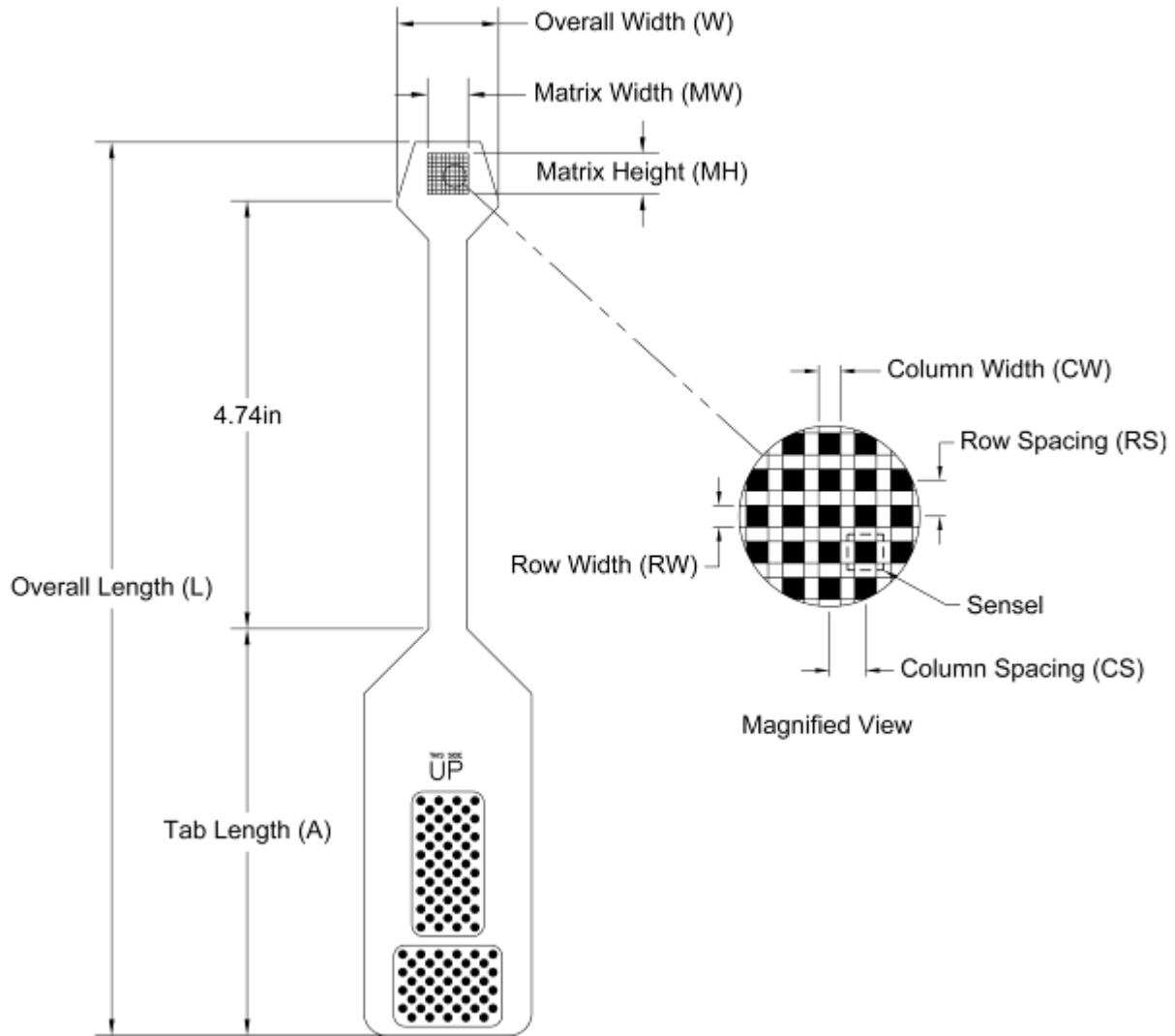

General Dimensions

Sensing Area Dimensions

Model	General Dimensions			Sensing Area Dimensions								Total No.of Sensels	Resolution Sensel Density
	Overall Length L	Overall Width W	Tab Length A	Matrix Width MW	Matrix Height MH	Columns			Rows				
	(in.)	(in.)	(in.)	(in.)	(in.)	CW	Pitch CS	Qty.	RW	Pitch RS	Qty.		(sensel per sq. in.)
US						(in.)	(in.)		(in.)	(in.)			
5800	9.96	1.15	4.51	0.50	0.50	0.010	0.050	10	0.010	0.050	10	100	400.0
5800N	9.92	1.09	4.45	0.47	0.47	0.020	0.050	10	0.020	0.050	10	100	400.0
Metric						(mm)	(mm)		(mm)	(mm)			(sensel per sq. cm)
5800	253.0	29.1	114.6	12.7	12.7	0.3	1.3	10	0.3	1.3	10	100	62.0
5800N	252.0	27.8	113.0	12.0	12.0	0.5	1.3	10	0.5	1.3	10	100	62.0

SENSOR MODEL: 6010N

Application Examples:

- Wafer polishing machine set-up
- CMP

Features: Works with wafers up to 12" diameter

Requirement: Dual Handles or Two *VersaTek*® Handles

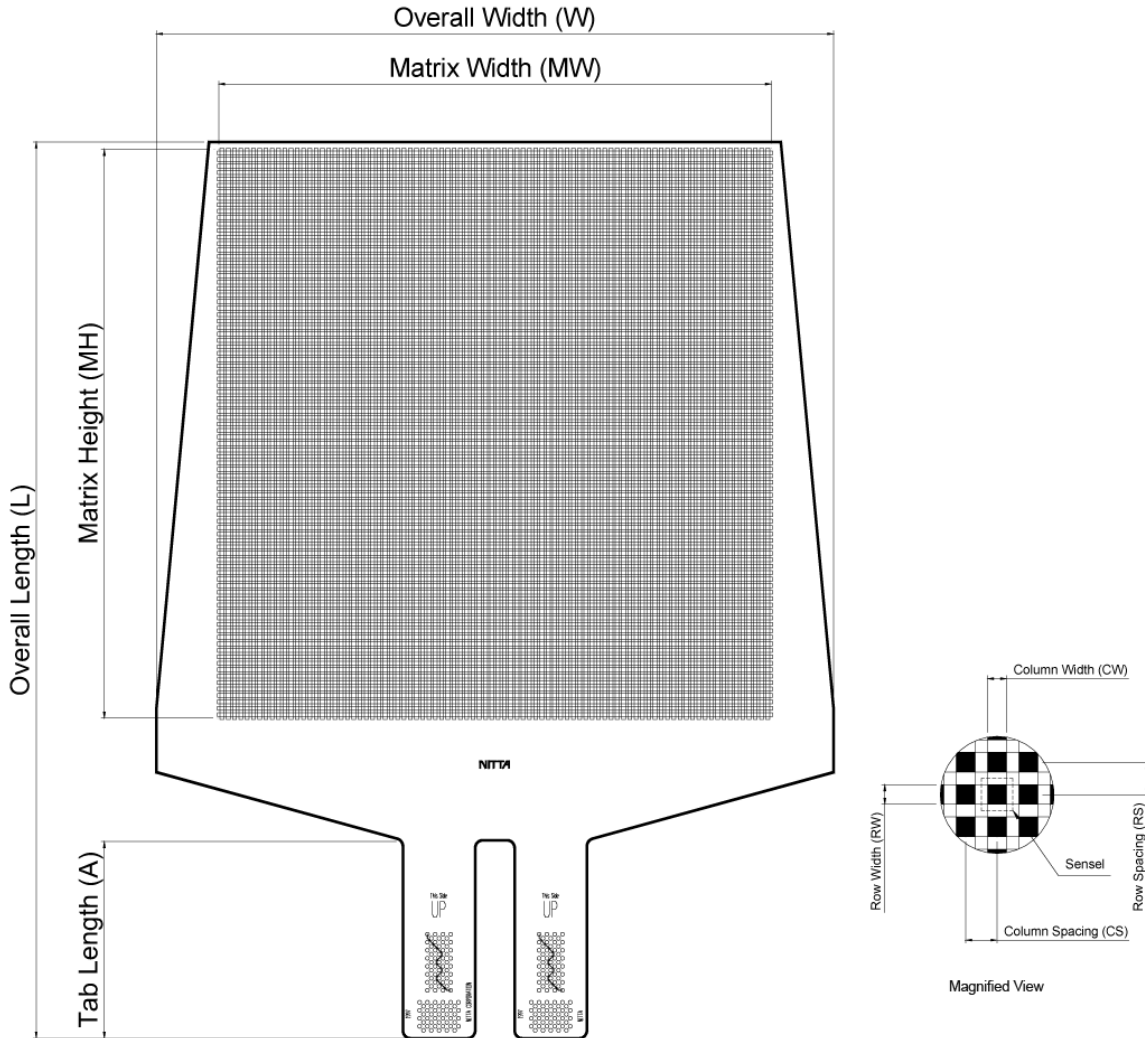

Model	Overall Length L	Overall Width W	Tab Length A	Matrix Width MW	Matrix Height MH	Columns			Rows			Total No. of Sensels	Resolution
						CW	Pitch CS	Qty.	RW	Pitch RS	Qty.		Sensel Density
US	(in.)	(in.)	(in.)	(in.)	(in.)	(in.)	(in.)		(in.)	(in.)		(sensel per sq. in.)	
5620N	14.96	13.78	10.20	12.65	1.73	0.118	0.287	44	0.016	0.039	44	1936	88.4
5630N	14.96	9.84	10.20	8.66	1.73	0.118	0.197	44	0.016	0.039	44	1936	129.0
Metric	(mm)	(mm)	(mm)	(mm)	(mm)	(mm)	(mm)		(mm)	(mm)		(sensel per sq. cm)	
5620N	380.0	350.0	259.0	321.2	44.0	3.0	7.3	44	0.4	1.0	44	1936	13.7

SENSOR MODEL: 6020N/6030N

Application Examples:

- Wafer polishing
- Carrier ring adjustment

Features:

- Works with 6", 8" and 12" diameter wafers
- Four sensing regions

Requirement: Dual Handles or Two *VersaTek*® Handles

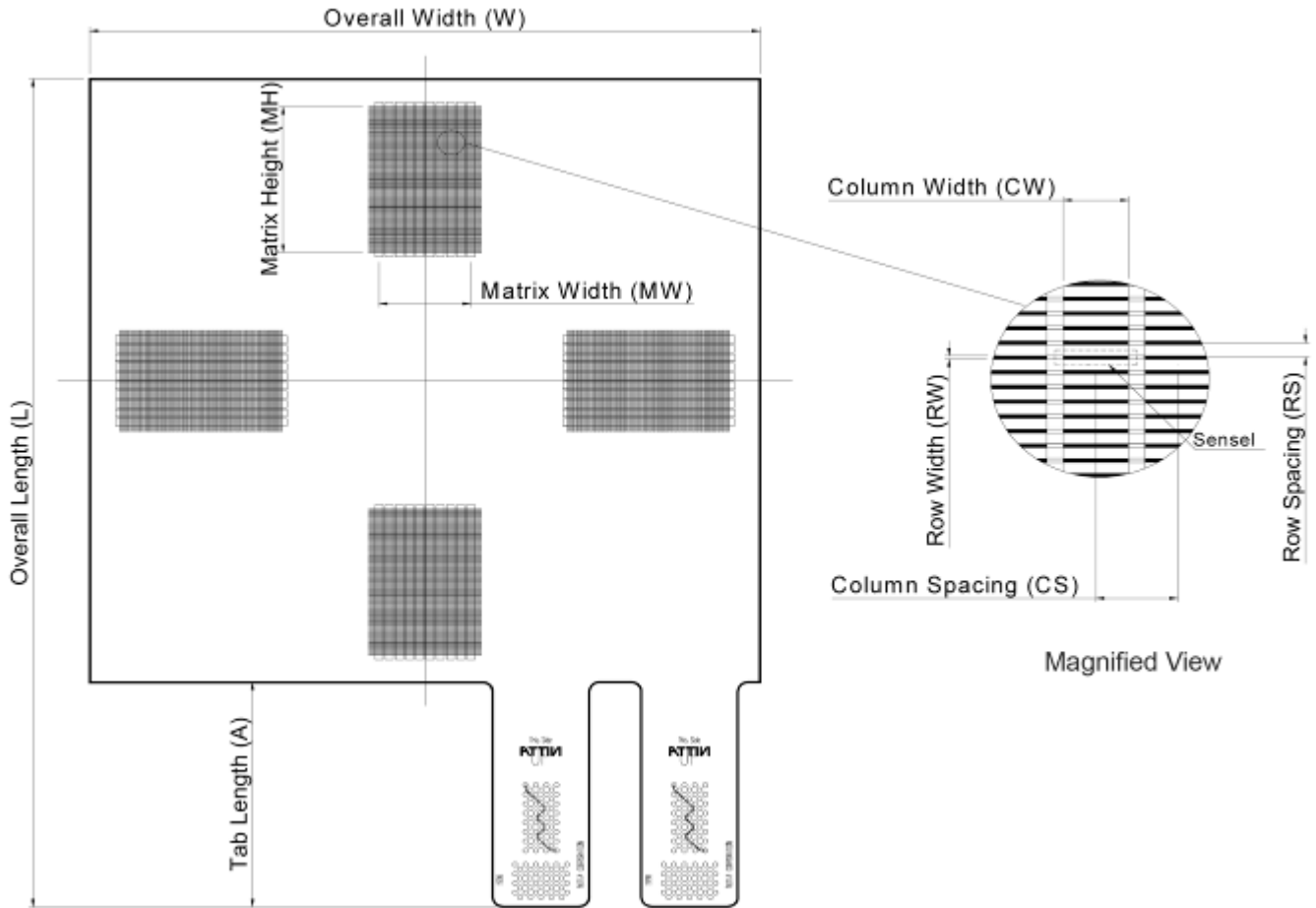

Model	General Dimensions			Sensing Area Dimensions								Total No. of Sensels	Resolution Sensel Density
	Overall Length L	Overall Width W	Tab Length A	Matrix Width MW	Matrix Height MH	Columns			Rows				
	(in.)	(in.)	(in.)	(in.)	(in.)	CW	Pitch CS	Qty.	RW	Pitch RS	Qty.		(sensel per sq. in.)
US 6010N	22.40	17.44	4.96	14.20	14.20	0.098	0.161	88	0.098	0.161	88	7744	38.4
Metric 6010N	(mm)	(mm)	(mm)	(mm)	(mm)	(mm)	(mm)		(mm)	(mm)			(sensel per sq. cm)
	569.0	443.0	126.0	360.8	360.8	2.5	4.1	88	2.5	4.1	88	7744	5.9

SENSOR MODEL: 6077

Application Example: Car door seals

Features:

- Low pressure applications
- No vent

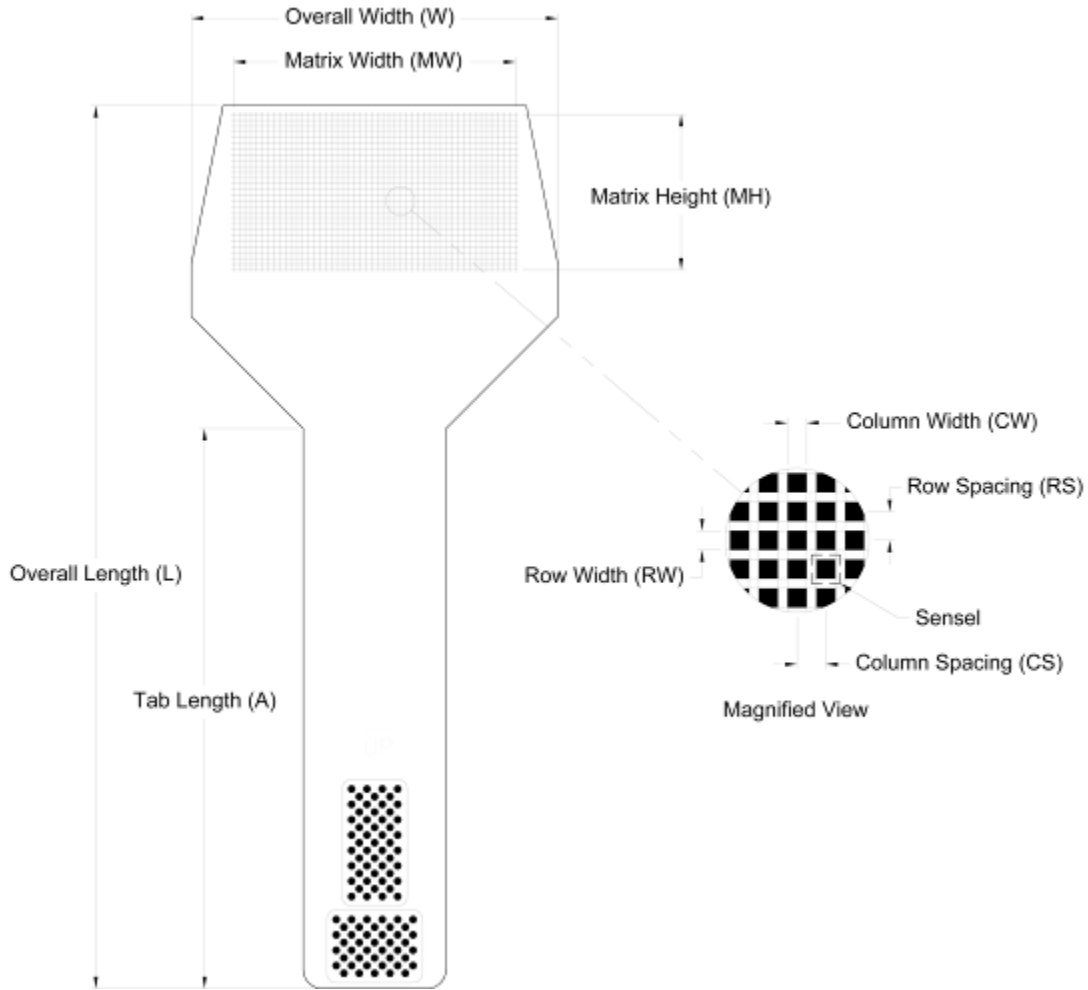

General Dimensions

Sensing Area Dimensions

Model	Overall Length L	Overall Width W	Tab Length A	Matrix Width MW	Matrix Height MH	Columns			Rows			Total No. of Sensels	Resolution Sensel Density
						CW	Pitch CS	Qty.	RW	Pitch RS	Qty.		
US 6077	(in.) 11.50	(in.) 4.78	(in.) 7.35	(in.) 3.75	(in.) 2.10	(in.) 0.050	(in.) 0.075	50	(in.) 0.050	(in.) 0.075	28	1400	(sensel per sq. in.) 177.8
Metric 6077	(mm) 292.1	(mm) 121.3	(mm) 186.8	(mm) 95.3	(mm) 53.3	(mm) 1.3	(mm) 1.9	50	(mm) 1.3	(mm) 1.9	28	1400	(sensel per sq. cm) 27.6

SENSOR MODEL: 6220/6230

Application Example:

- Fasteners, o-rings, annular gaskets, bolts, rivets, and jounce bumpers
- Similar to load washers

Features:

- Center hole in sensor can be "punched out" to any size without damaging the sensor, thus fitting various bolt sizes
- Internal vent

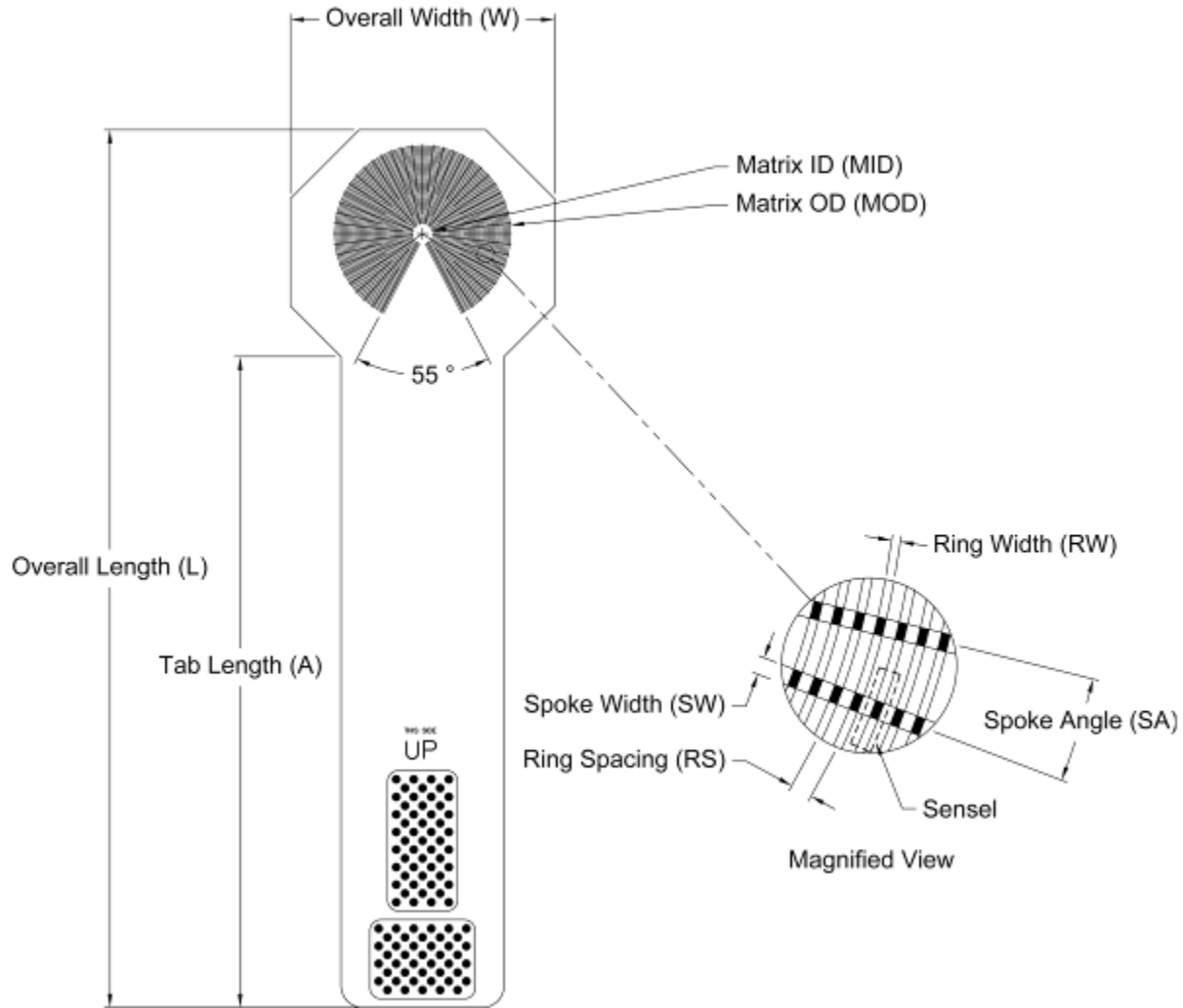

Model	General Dimensions			Sensing Area Dimensions								Summary	
	Overall Length L	Overall Width W	Tab Length A	Matrix ID MID	Matrix OD MOD	Spokes			Rings		Total No. of Sensels	Avg. Sensel Spatial Resolution	
	(in.)	(in.)	(in.)	(in.)	(in.)	SW	SA	Qty.	RW	RS	Qty.		(sensel per sq. in.)
US													
6220	10.00	3.01	7.47	0.25	2.00	0.020	6.916	45	0.010	0.025	36	1235	471.4
6230	11.00	4.03	3.29	0.80	2.95	0.010	6.400	51	0.010	0.025	44	2244	418.3
Metric													
6220	254.0	76.6	189.8	6.4	50.8	0.5	6.9	45	0.3	0.6	36	1235	73.1
6230	279.4	102.4	83.6	20.3	74.9	0.3	6.4	51	0.3	0.6	44	2244	64.8

SENSOR MODEL: 6300

Application Examples: Car door seals, oil pan seals and roller roundness measurements

Features:

- Sensor can be cut from either edge to make it shorter or narrower without affecting the output
- Internal vent

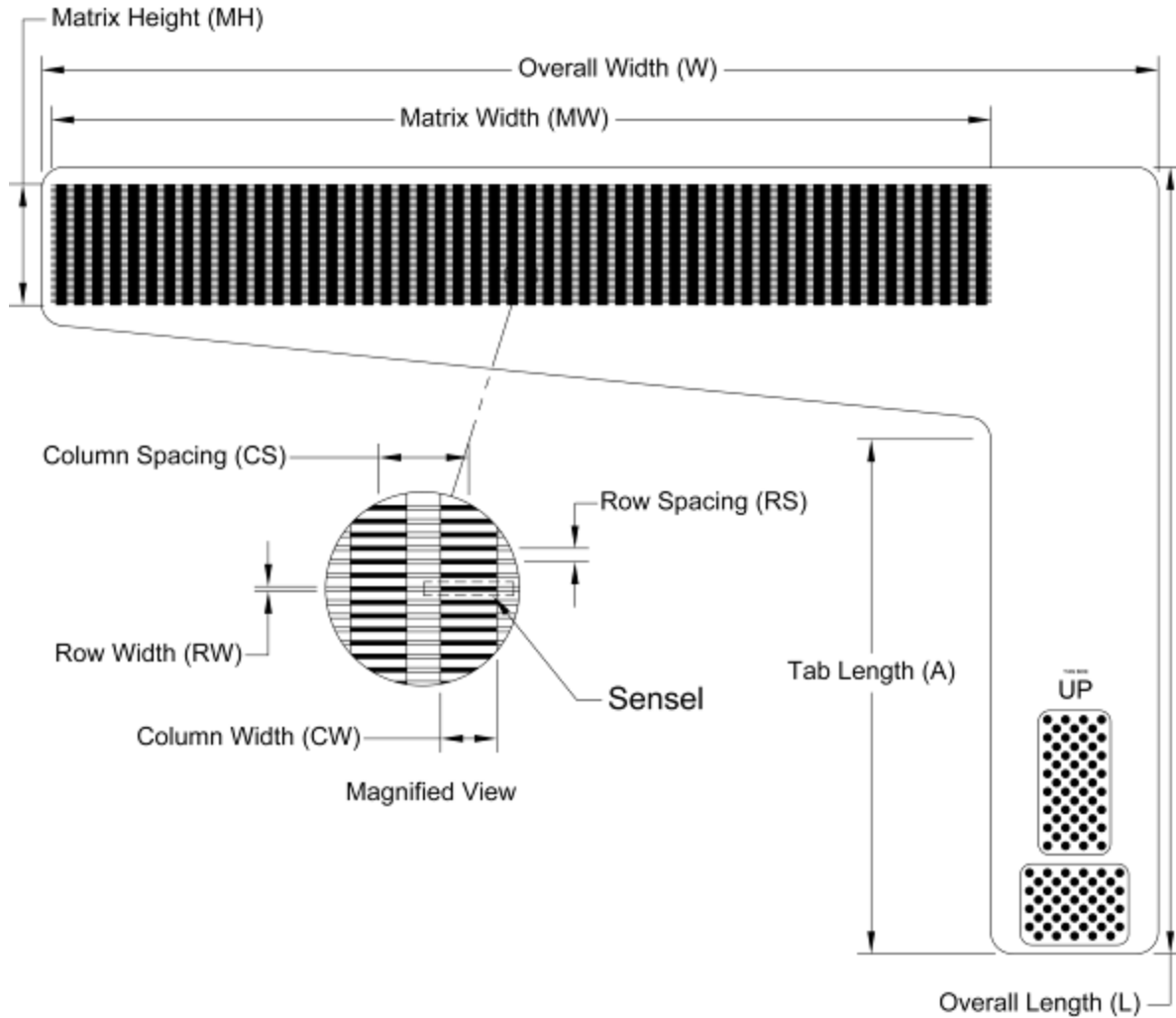

General Dimensions

Sensing Area Dimensions

Model	General Dimensions			Sensing Area Dimensions								Total No. of Sensels	Resolution Sensel Density	
	Overall Length L	Overall Width W	Tab Length A	Matrix Width MW	Matrix Height MH	Columns			Rows					
	(in.)	(in.)	(in.)	(in.)	(in.)	CW	Pitch CS	Qty.	RW	Pitch RS	Qty.		(sensel per sq. in.)	
US 6300	8.73	12.39	5.71	10.40	1.32	0.125	0.200	52	0.010	0.030	44	2288	166.7	
Metric 6300	(mm)	(mm)	(mm)	(mm)	(mm)	(mm)	(mm)	(mm)	(mm)	(mm)	(mm)	(mm)	(mm)	(sensel per sq. cm)
	221.7	314.6	145.0	264.2	33.5	3.2	5.1	52	0.3	0.8	44	2288	25.8	

SENSOR MODEL: 6500/6510

Application Examples: Combustion opening of head gasket, automatic transmission clutch packs, and large springs

Features:

- Holes can be punched at outer edges of sensor without affecting measurement of inner sensing rings
- Allows bolting of engine gasket block and engine cylinder head
- Can be pressurized
- No vent

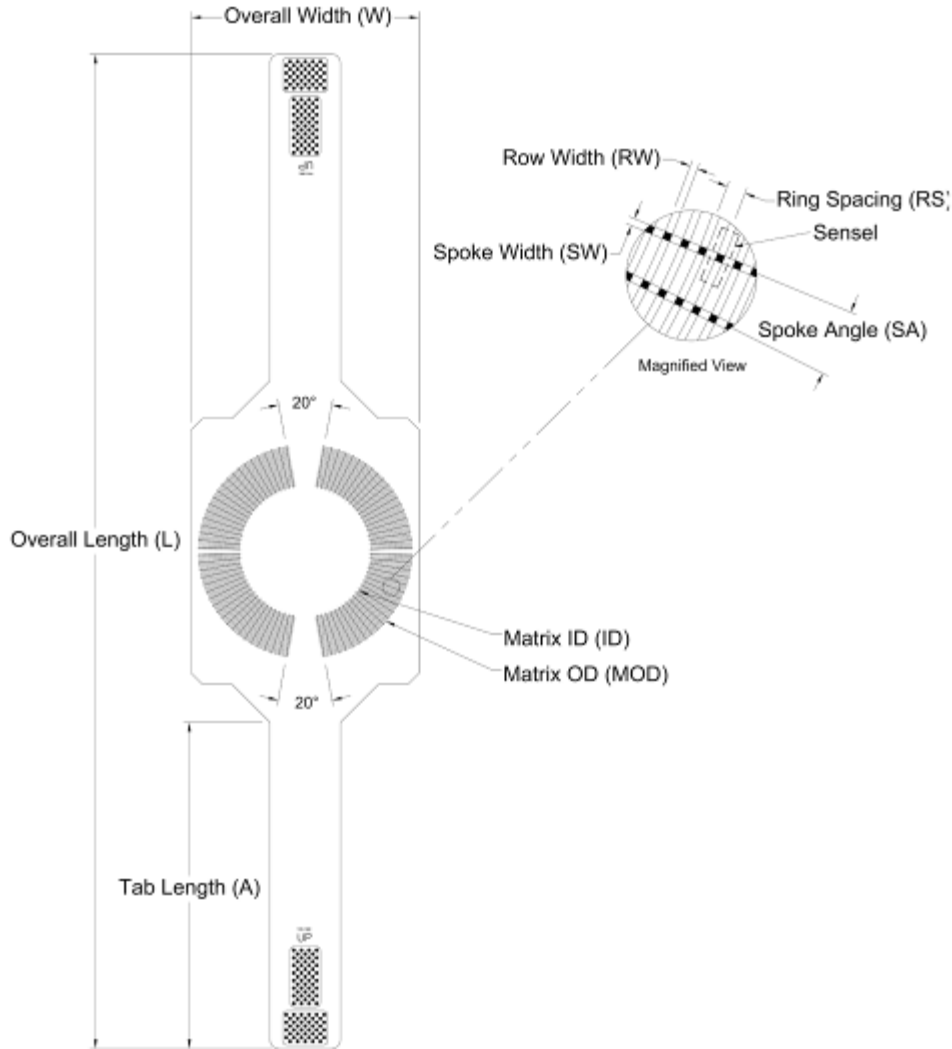

Model	General Dimensions			Sensing Area Dimensions								Summary	
	Overall Length L	Overall Width W	Tab Length A	Matrix ID MID	Matrix OD MOD	Spokes			Rings		Total No.of Sensels	Avg. Sensel Spatial Resolution	
	(in.)	(in.)	(in.)	(in.)	(in.)	(in.)	(in.)	Qty.	RW	RS	Qty.		(sensel per sq. in.)
US													
6500	26.22	6.00	8.61	3.50	5.60	0.020	4.000	80	0.020	0.050	22	1760	131.8
6510	26.22	6.00	8.61	3.02	5.12	0.020	4.000	80	0.020	0.050	22	1760	147.7
Metric													
6500	666.0	152.4	218.7	88.9	142.3	0.5	4	80	0.5	1.3	22	1760	20.4
6510	666.0	152.4	218.7	76.6	129.9	0.5	4	80	0.5	1.3	22	1760	22.9

SENSOR MODEL: 6700

Application Example: Automobile wheel hubs

Features:

- Trimmable to two wheel hub sizes
- Five precut holes for lugs
- Internal vent

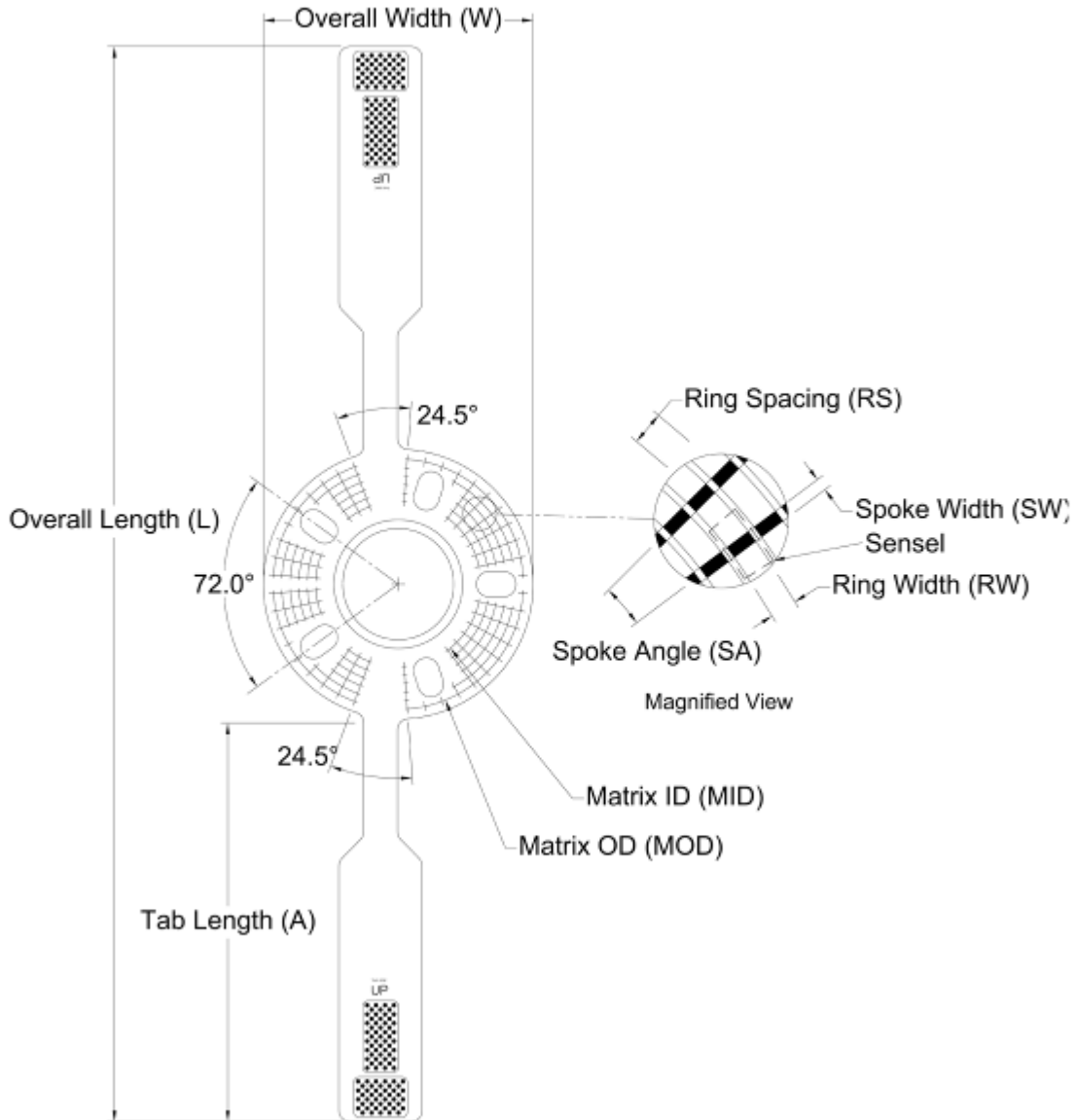

Model	General Dimensions			Sensing Area Dimensions								Summary	
	Overall Length L	Overall Width W	Tab Length A	Matrix ID MID	Matrix OD MOD	Spokes			Rings		Total No. of Sensels	Avg. Sensel Spatial Resolution	
	(in.)	(in.)	(in.)	(in.)	(in.)	(in.)	(in.)	Qty.	(in.)	(in.)	Qty.		(sensel per sq. in.)
US 6700	24.00	6.02	8.75	3.68	5.58	0.070	8.200	40	0.150	0.190	6	174	14.5
Metric 6700	609.6	153.0	222.2	93.4	141.8	1.8	8.2	40	3.8	4.8	6	174	2.3

SENSOR MODEL: 6900

Application Examples: Robot grippers, engine gaskets, automatic transmission seals, and non-regular or non-coplanar seals

Features:

- Four independent sensing fingers
- Internal vent

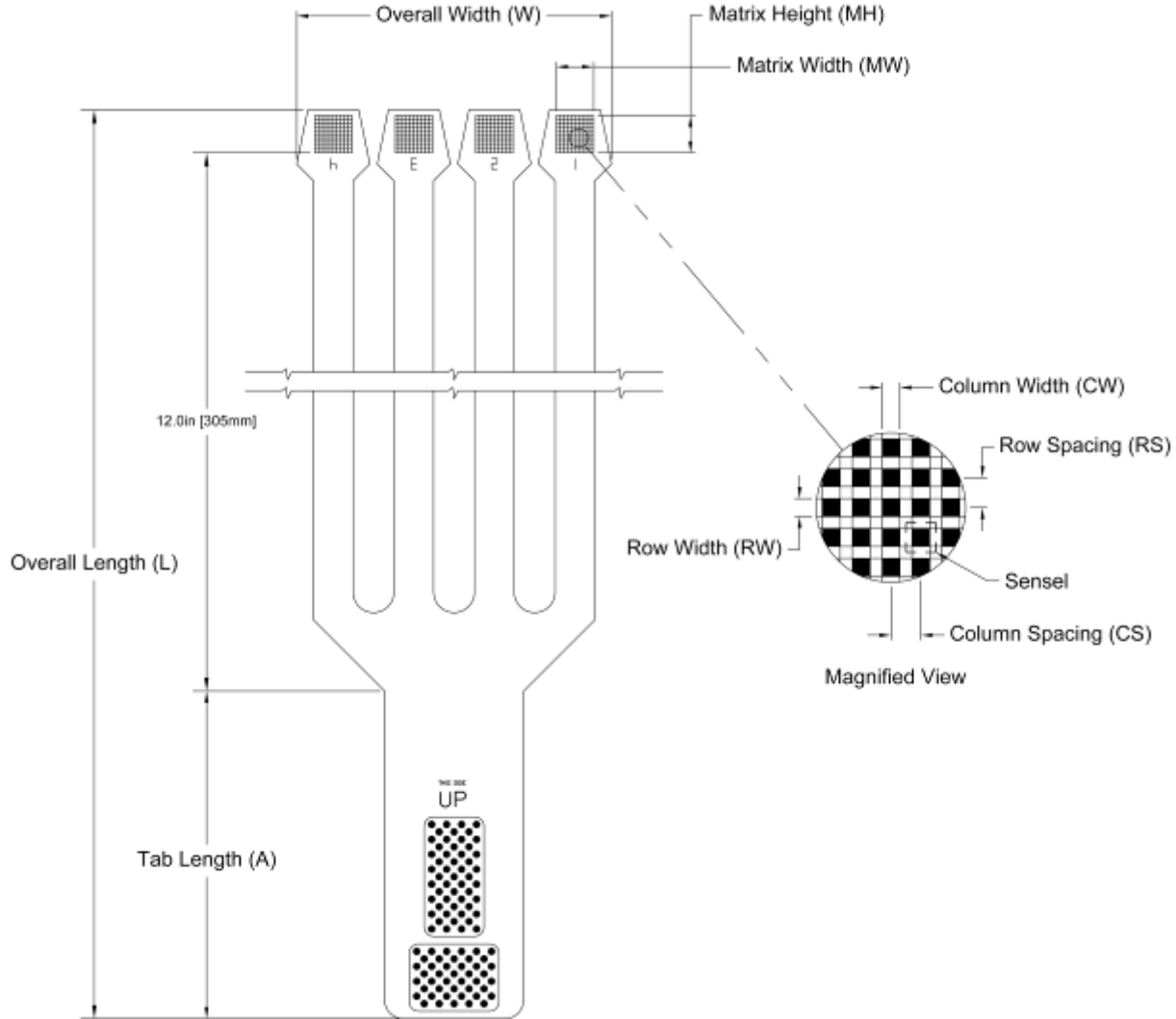

General Dimensions

Sensing Area Dimensions

Model	General Dimensions			Sensing Area Dimensions								Total No. of Sensels	Resolution Sensel Density
	Overall Length L	Overall Width W	Tab Length A	Matrix Width MW	Matrix Height MH	Columns			Rows				
	(in.)	(in.)	(in.)	(in.)	(in.)	CW	Pitch CS	Qty.	RW	Pitch RS	Qty.		(sensel per sq. in.)
US 6900	17.00	4.21	4.39	0.55	0.55	0.025	0.050	11	0.025	0.050	11	121	400.0
Metric 6900	(mm)	(mm)	(mm)	(mm)	(mm)	(mm)	(mm)		(mm)	(mm)		121	(sensel per sq. cm)
	431.8	107.0	111.4	14.0	14.0	0.6	1.3	11	0.6	1.3	11	121	62.0

SENSOR MODEL: 6911

Application Example: Sensing for human fingertips

Features:

- Four independent sensing fingers
- Internal vent

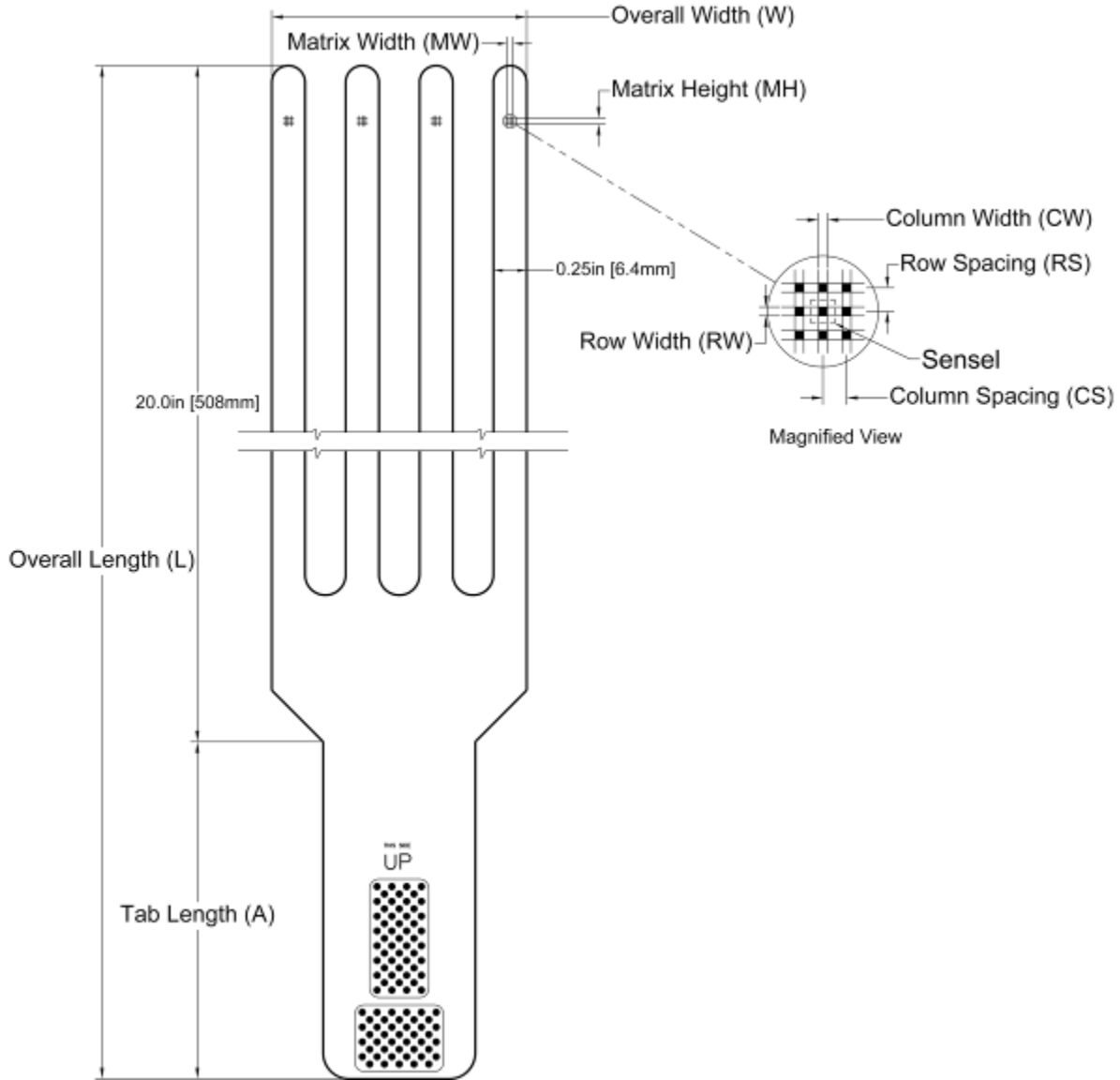

General Dimensions

Sensing Area Dimensions

Model	General Dimensions			Sensing Area Dimensions								Resolution	
	Overall Length L	Overall Width W	Tab Length A	Matrix Width MW	Matrix Height MH	Columns			Rows		Total No.of Sensels		Sensel Density
	(in.)	(in.)	(in.)	(in.)	(in.)	CW	Pitch CS	Qty.	RW	Pitch RS		Qty.	
US 6911	24.50	3.25	4.46	0.12	0.12	0.015	0.040	3	0.015	0.040	3	9	625.0
Metric 6911	(mm) 622.3	(mm) 82.6	(mm) 113.2	(mm) 3.0	(mm) 3.0	(mm) 0.4	(mm) 1.0	3	(mm) 0.4	(mm) 1.0	3	9	(sensel per sq. cm) 96.9

SENSOR MODEL: 7101

Application Examples:

- High resolution mat for barefoot analysis
- Tire foot prints and fuel cells

Features: External vents

Requirement: Dual Handles or 2 *VersaTek*® Handles

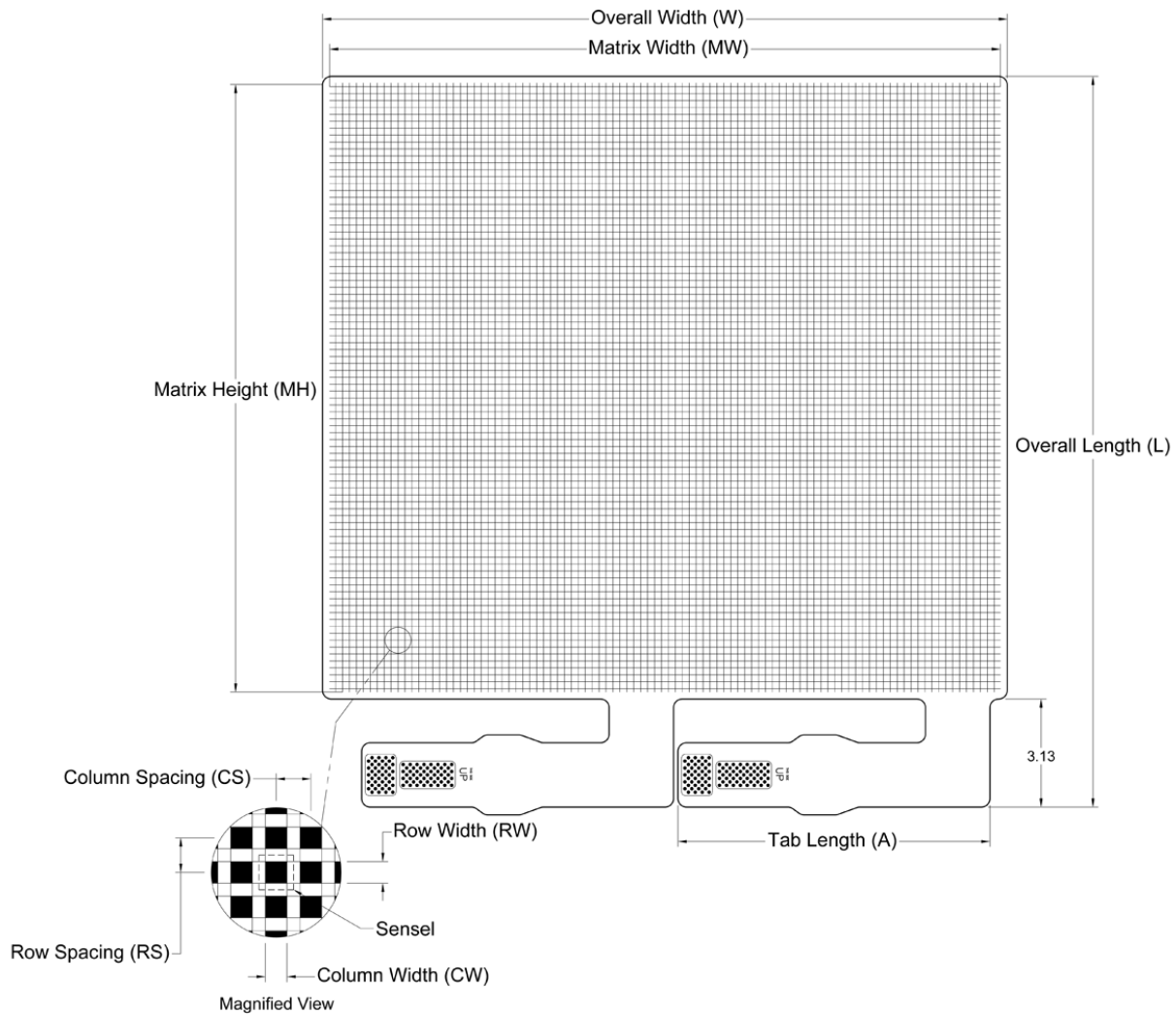

General Dimensions

Sensing Area Dimensions

Model	General Dimensions			Sensing Area Dimensions								Total No. of Sensels	Resolution Sensel Density
	Overall Length L	Overall Width W	Tab Length A	Matrix Width MW	Matrix Height MH	Columns			Rows				
	(in.)	(in.)	(in.)	(in.)	(in.)	CW	Pitch CS	Qty.	RW	Pitch RS	Qty.		(sensel per sq. in.)
US 7101	21.35	19.75	9.00	19.20	17.60	0.125	0.200	96	0.125	0.200	88	8448	25.0
Metric 7101	(mm)	(mm)	(mm)	(mm)	(mm)	(mm)	(mm)	96	(mm)	(mm)	88	8448	(sensel per sq. cm)
	542.3	501.7	228.6	487.7	447.0	3.2	5.1	96	3.2	5.1	88	8448	3.9

SENSOR MODEL: 7501

Application Examples:

- Piston and cylinder wall pressures
- Tire tread blocks

Features:

- 8,800 sensing elements
- Internal vent

Requirement: Dual Handles or 2 *VersaTek*® Handles

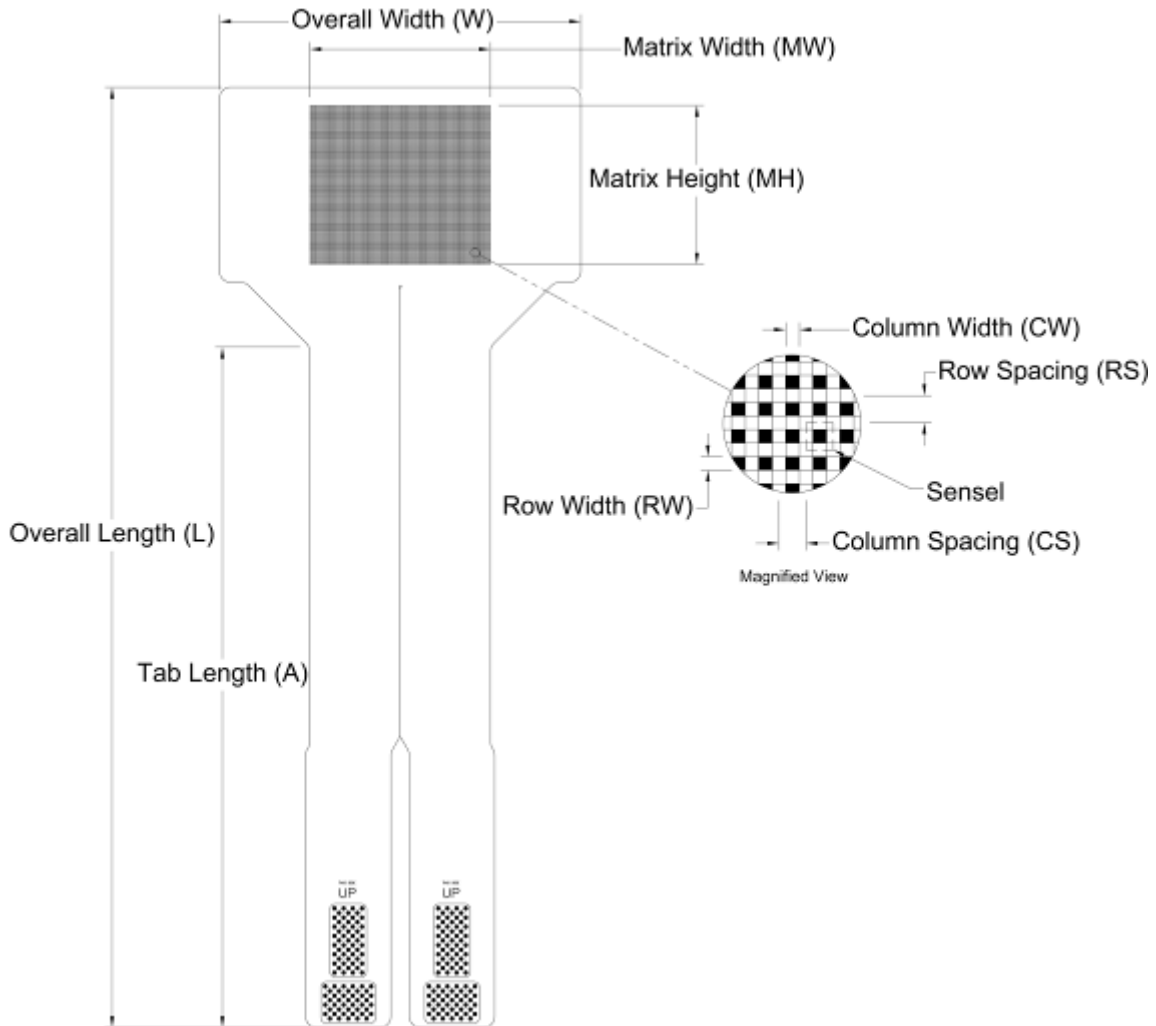

General Dimensions

Sensing Area Dimensions

Model	General Dimensions			Sensing Area Dimensions								Total No. of Sensels	Resolution Sensel Density
	Overall Length L	Overall Width W	Tab Length A	Matrix Width MW	Matrix Height MH	Columns			Rows				
						CW	Pitch CS	Qty.	RW	Pitch RS	Qty.		
US 7501	(in.) 20.49	(in.) 7.87	(in.) 14.73	(in.) 3.94	(in.) 3.47	(in.) 0.020	(in.) 0.039	100	(in.) 0.020	(in.) 0.039	88	8800	(sensel per sq. in.) 644.2
Metric 7501	(mm) 520.4	(mm) 200.0	(mm) 374.2	(mm) 100.1	(mm) 88.1	(mm) 0.5	(mm) 1.0	100	(mm) 0.5	(mm) 1.0	88	8800	(sensel per sq. cm) 99.8

SENSOR MODEL: 8000

Application Examples:

- Tire footprints
- Fuel cells

Feature: External vents

Requirement: Dual Handles or 2 *VersaTek*[®] Handles

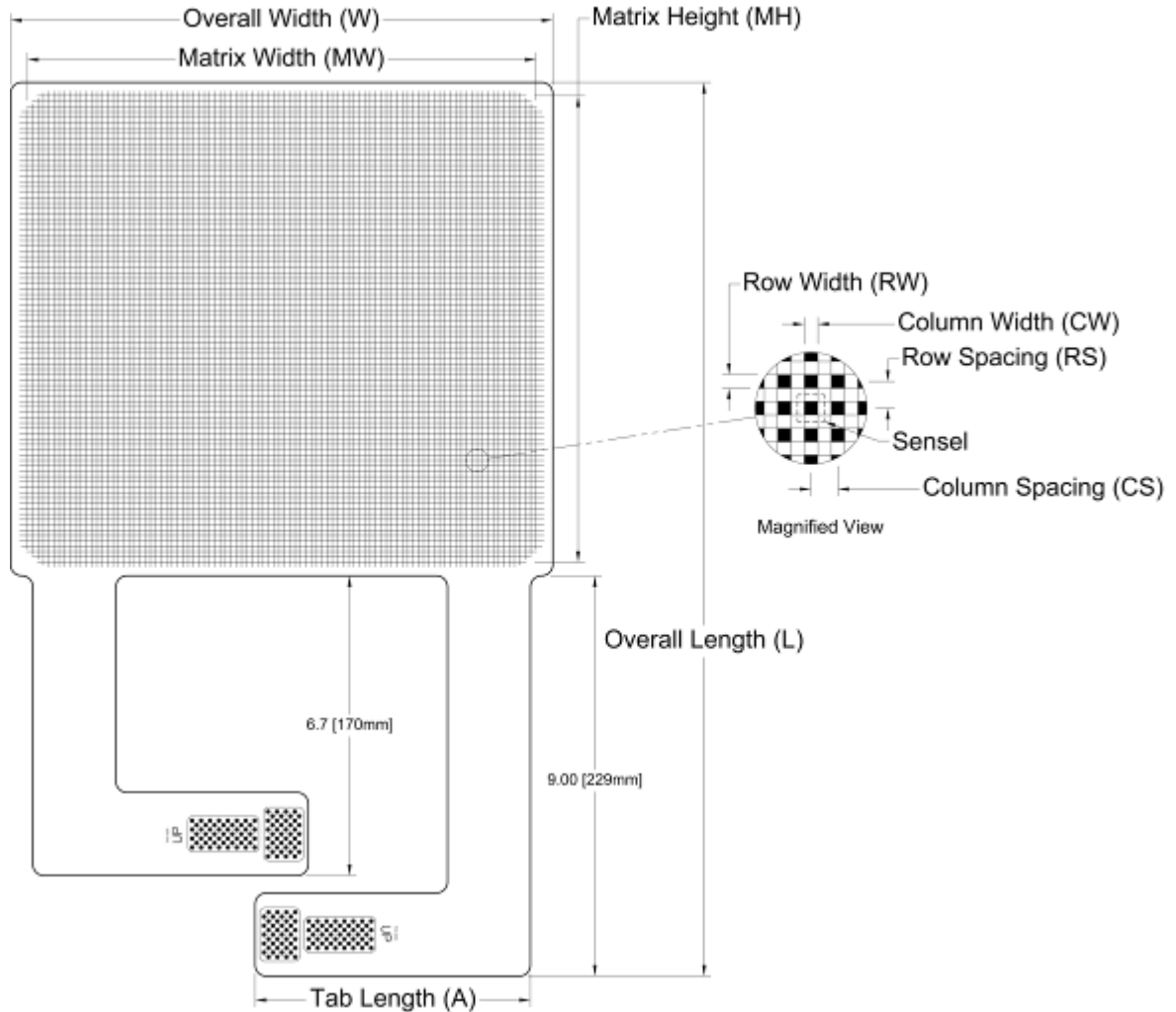

General Dimensions

Sensing Area Dimensions

Model	General Dimensions			Sensing Area Dimensions								Resolution Sensel Density	
	Overall Length L	Overall Width W	Tab Length A	Matrix Width MW	Matrix Height MH	Columns			Rows		Total No. of Sensels		
	(in.)	(in.)	(in.)	(in.)	(in.)	CW	Pitch CS	Qty.	RW	Pitch RS	Qty.		
US 8000	20.00	12.15	6.17	11.52	10.56	0.060	0.120	96	0.060	0.120	88	8448	(sensel per sq. in.) 69.4
Metric 8000	508.0	308.6	156.7	292.6	268.2	1.5	3.0	96	1.5	3.0	88	8448	(sensel per sq. cm) 10.8

307 West First St., South Boston, MA 02127

Tel: 617.464.4500/800.248.3669 fax: 617.464.4266 web: www.tekscan.com

SENSOR MODEL: 8050

Application Example:

- Tire footprints
- Fuel cells

Feature: External vents

Requirement: 4 Dual Handles or 8 VersaTek® Handles

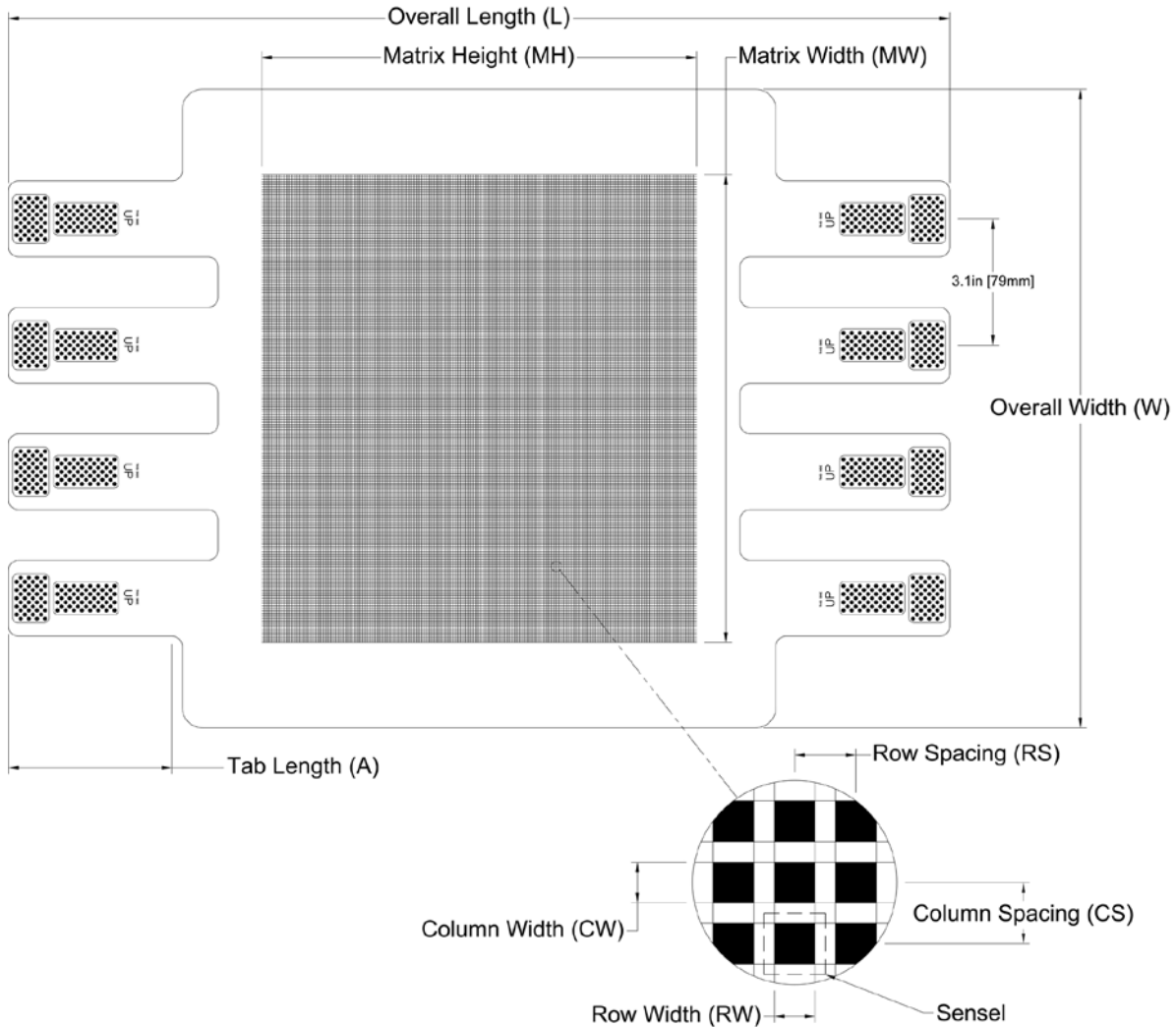

General Dimensions

Sensing Area Dimensions

Model	General Dimensions			Sensing Area Dimensions								Total No. of Sensels	Resolution Sensel Density
	Overall Length L	Overall Width W	Tab Length A	Matrix Width MW	Matrix Height MH	Columns			Rows				
	(in.)	(in.)	(in.)	(in.)	(in.)	CW	Pitch CS	Qty.	RW	Pitch RS	Qty.		(sensel per sq. in.)
US 8050	23.04	15.64	4.01	11.52	10.56	0.040	0.060	192	0.040	0.060	176	33792	277.8
Metric 8050	(mm)	(mm)	(mm)	(mm)	(mm)	(mm)	(mm)		(mm)	(mm)			(sensel per sq. cm)
	585.2	397.3	101.7	292.6	268.2	1.0	1.5	192	1.0	1.5	176	33792	43.1

SENSOR MODEL: 8100

Application Examples:

- Tire beads
- Corner of car door seals

Feature: Internal vent

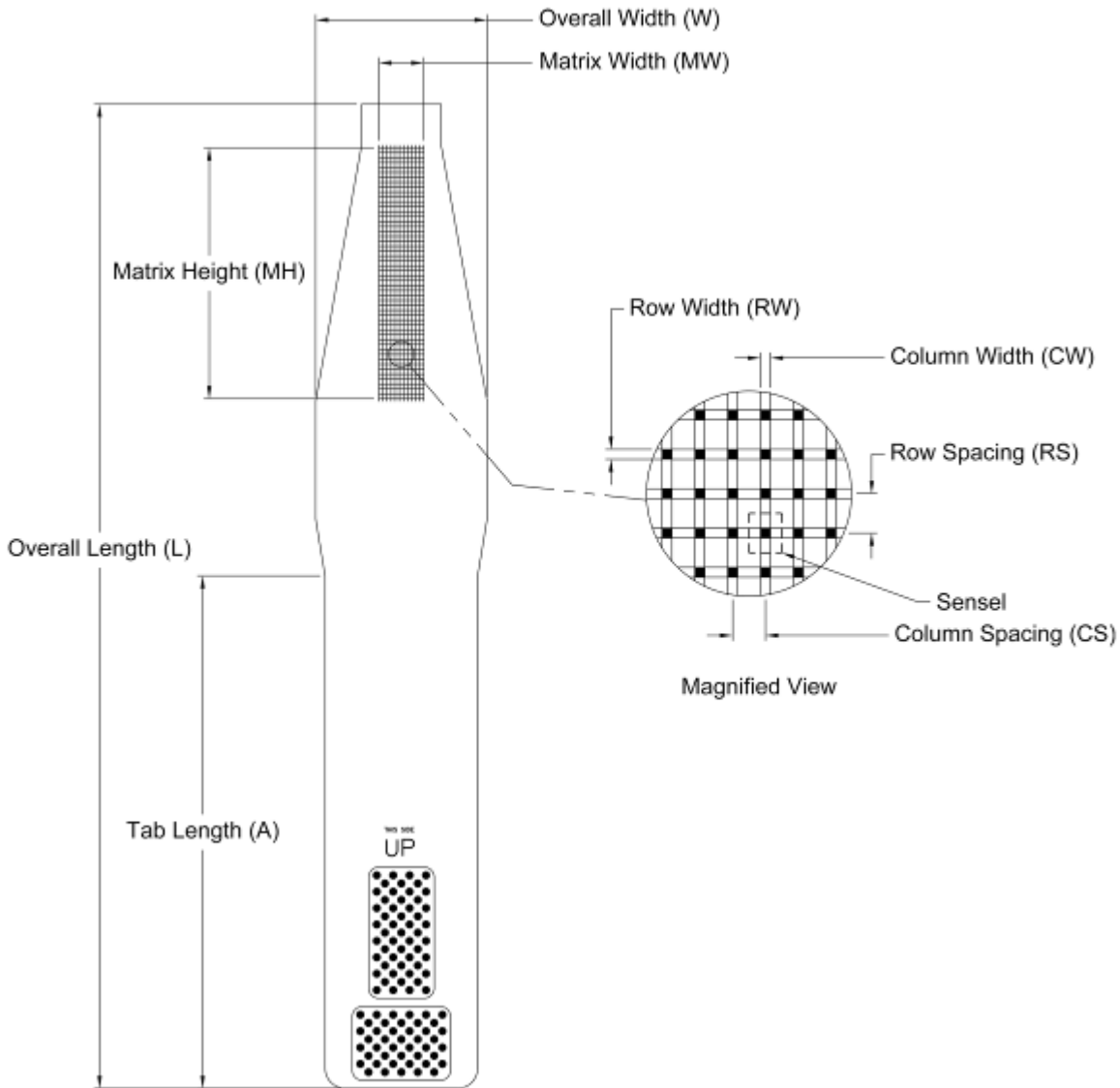

General Dimensions

Sensing Area Dimensions

Model	General Dimensions			Sensing Area Dimensions								Resolution	
	Overall Length L	Overall Width W	Tab Length A	Matrix Width MW	Matrix Height MH	Columns			Rows			Total No.of Sensels	Sensel Density
	(in.)	(in.)	(in.)	(in.)	(in.)	CW	Pitch CS	Qty.	RW	Pitch RS	Qty.		(sensel per sq. in.)
US 8100	12.00	2.09	6.25	0.60	3.12	0.015	0.050	12	0.015	0.060	52	624	333.3
Metric 8100	(mm)	(mm)	(mm)	(mm)	(mm)	(mm)	(mm)	12	(mm)	(mm)	52	624	(sensel per sq. cm)
	304.8	53.1	158.8	15.2	79.2	0.4	1.3	12	0.4	1.5	52	624	51.7

SENSOR MODEL: 8110

Application Example: Aircraft tire beads

Feature: Internal vents

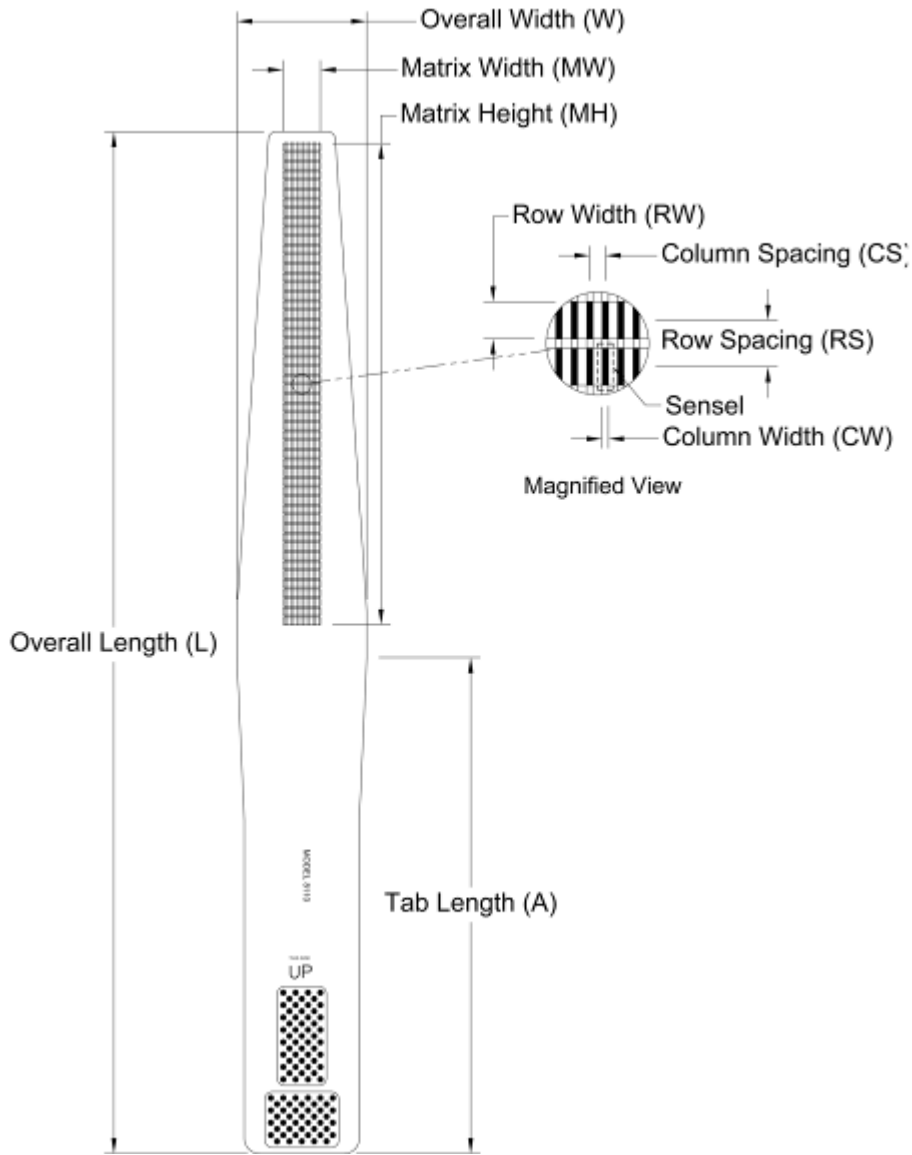

General Dimensions

Sensing Area Dimensions

Model	General Dimensions			Sensing Area Dimensions								Resolution	
	Overall Length L	Overall Width W	Tab Length A	Matrix Width MW	Matrix Height MH	Columns			Rows		Total No. of Sensels	Sensel Density	
						CW	Pitch CS	Qty.	RW	Pitch RS			Qty.
US 8110	(in.) 17.00	(in.) 2.10	(in.) 8.01	(in.) 0.60	(in.) 7.80	(in.) 0.020	(in.) 0.050	12	(in.) 0.120	(in.) 0.150	52	624	(sensel per sq. in.) 133.3
Metric 8110	(mm) 431.8	(mm) 53.3	(mm) 203.5	(mm) 15.2	(mm) 198.1	(mm) 0.5	(mm) 1.3	12	(mm) 3.0	(mm) 3.8	52	624	(sensel per sq. cm) 20.7

SENSOR MODEL: 8150

Application Example: Large truck tire beads

Features: Internal and external vents

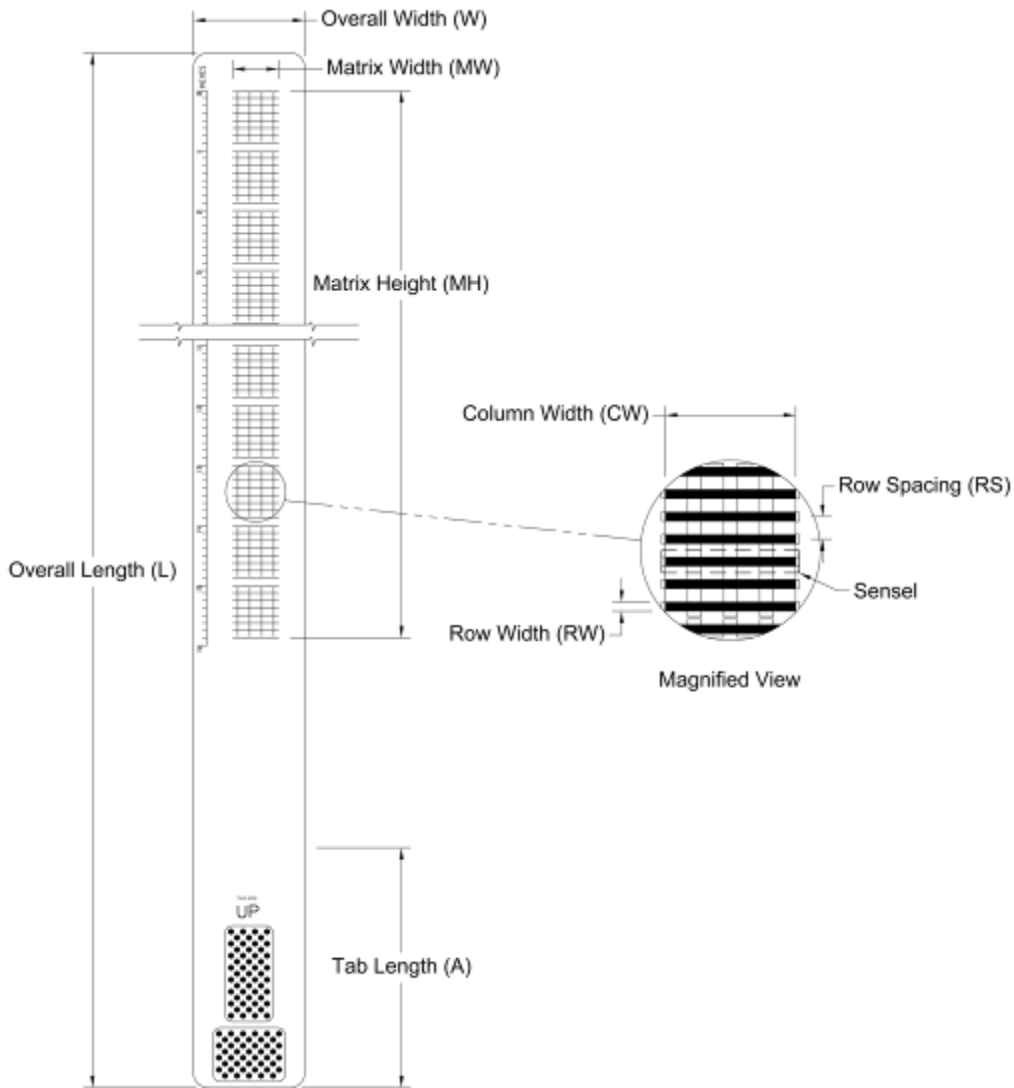

General Dimensions

Sensing Area Dimensions

Model	General Dimensions			Sensing Area Dimensions								Resolution	
	Overall Length L	Overall Width W	Tab Length A	Matrix Width MW	Matrix Height MH	Columns			Rows		Total No. of Sensels	Sensel Density	
						CW	Pitch CS	Qty.	RW	Pitch RS			Qty.
US 8150	(in.) 24.00	(in.) 1.86	(in.) 4.00	(in.) 0.73	(in.) 16.00	(in.) 0.725	(in.) 0.000	1	(in.) 0.050	(in.) 0.125	128	128	(sensel per sq. in.) 8.0
Metric 8150	(mm) 609.6	(mm) 47.2	(mm) 101.6	(mm) 18.4	(mm) 406.4	(mm) 18.4	(mm) 0.0	1	(mm) 1.3	(mm) 3.2	128	128	(sensel per sq. cm) 3.1

SENSOR MODEL: 8155

Application Example: Large truck tire beads and molds

Features: External vents

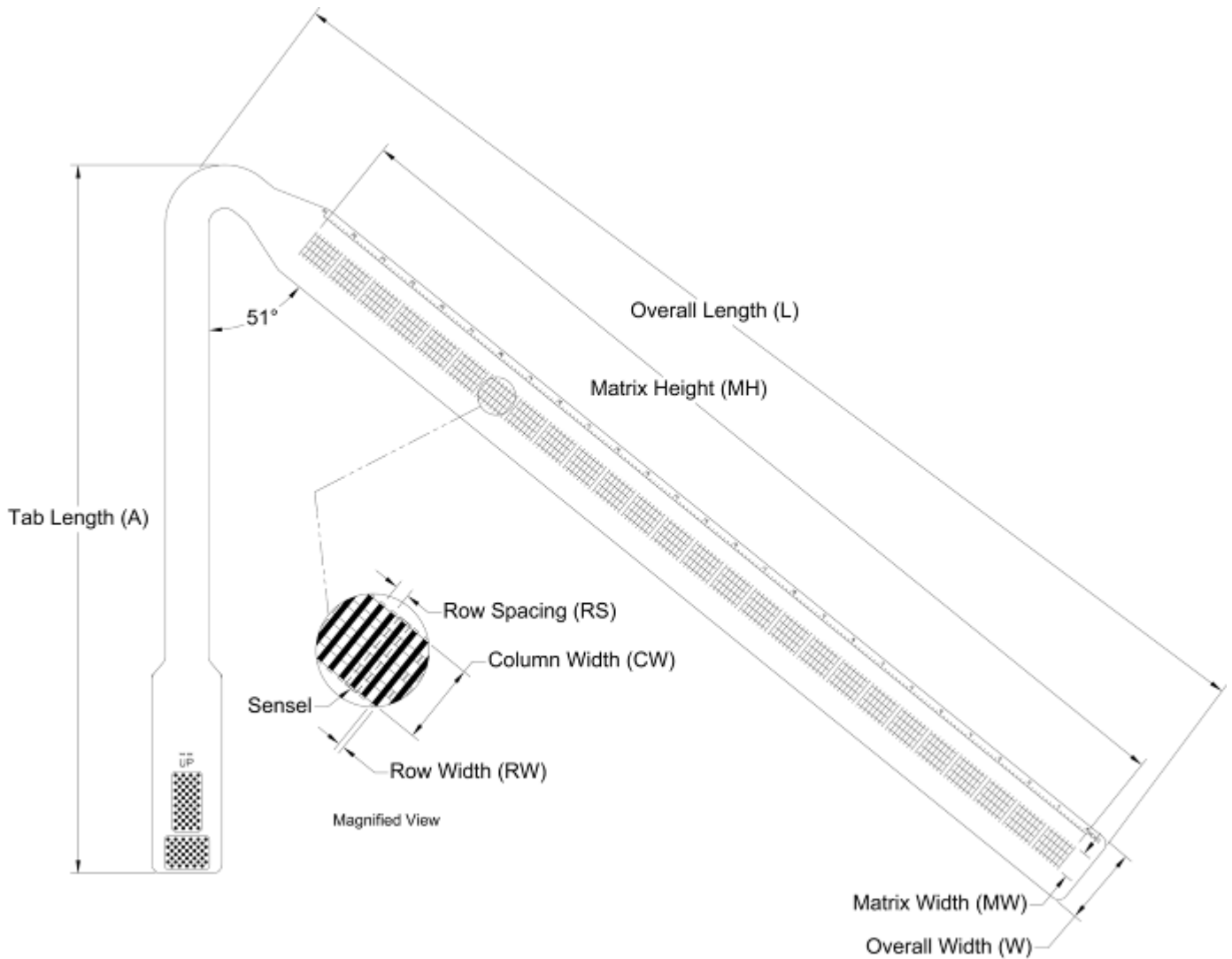

General Dimensions

Sensing Area Dimensions

Model	Overall Length L	Overall Width W	Tab Length A	Matrix Width MW	Matrix Height MH	Columns			Rows			Total No. of Sensels	Resolution Sensel Density
						CW	Pitch CS	Qty.	RW	Pitch RS	Qty.		
US 8155	(in.) 30.00	(in.) 2.08	(in.) 18.80	(in.) 0.73	(in.) 26.00	(in.) 0.725	(in.) 0.000	1	(in.) 0.050	(in.) 0.125	208	208	(sensel per sq. in.) 8.0
Metric 8155	(mm) 762.0	(mm) 52.9	(mm) 477.4	(mm) 18.4	(mm) 660.4	(mm) 18.4	(mm) 0.0	1	(mm) 1.3	(mm) 3.2	208	208	(sensel per sq. cm) 3.1

SENSOR MODEL: 8400

Application Example: Tire footprints

Requirement: 4 VersaTek® Handles

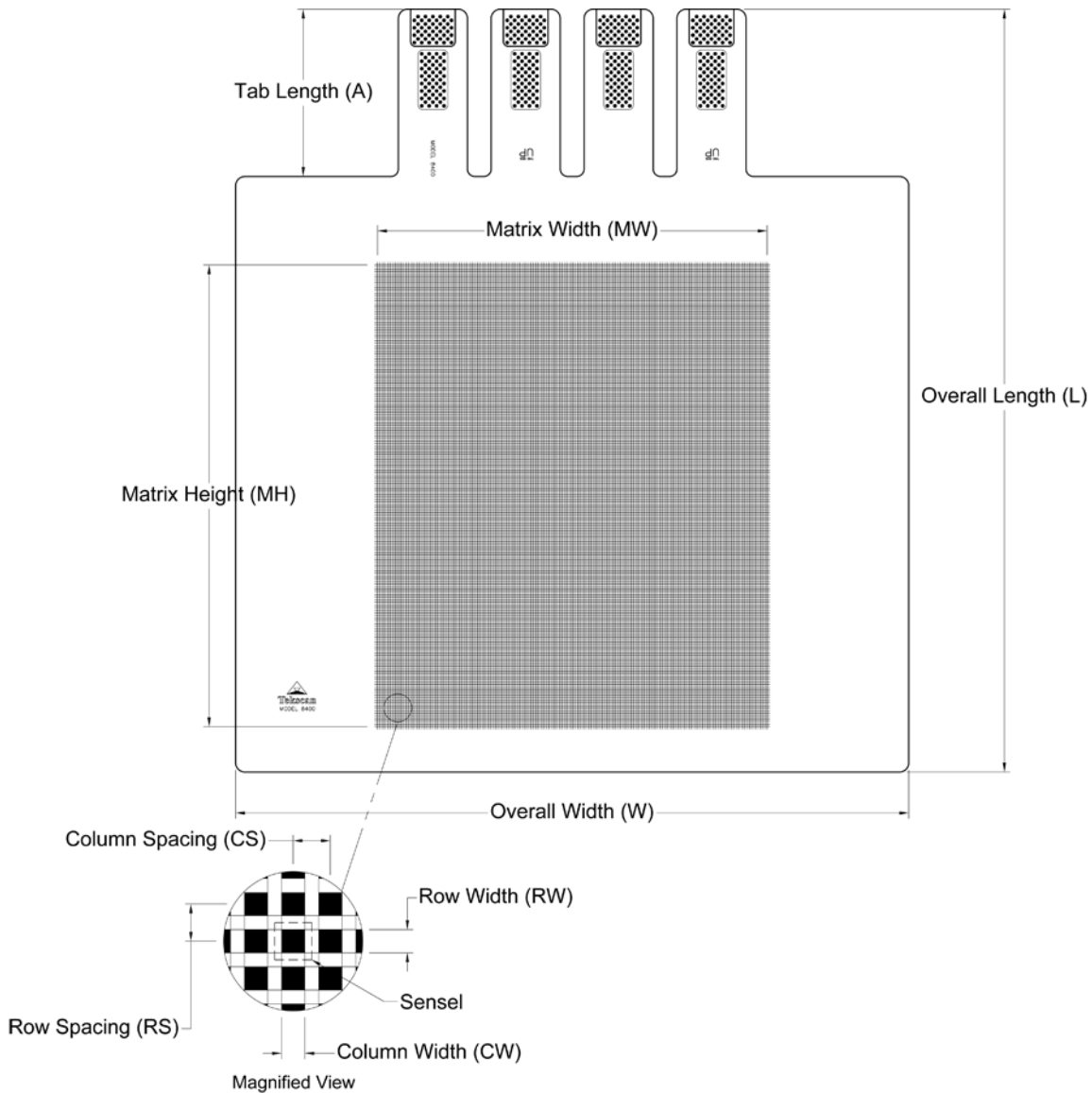

General Dimensions

Sensing Area Dimensions

Model	General Dimensions			Sensing Area Dimensions								Total No. of Sensels	Resolution Sensel Density
	Overall Length L	Overall Width W	Tab Length A	Matrix Width MW	Matrix Height MH	Columns			Rows				
	(in.)	(in.)	(in.)	(in.)	(in.)	CW	Pitch CS	Qty.	RW	Pitch RS	Qty.		(sensel per sq. in.)
US 8400	20.50	18.12	4.50	10.56	12.48	0.040	0.060	176	0.040	0.060	208	36608	277.8
Metric 8400	(mm)	(mm)	(mm)	(mm)	(mm)	(mm)	(mm)		(mm)	(mm)			(sensel per sq. cm)
	520.7	460.2	114.3	268.2	317.0	1.0	1.5	176	1.0	1.5	208	36608	43.1

SENSOR MODEL: 8405

Application Example: Tire footprints

Requirement: 6 VersaTek® Handles

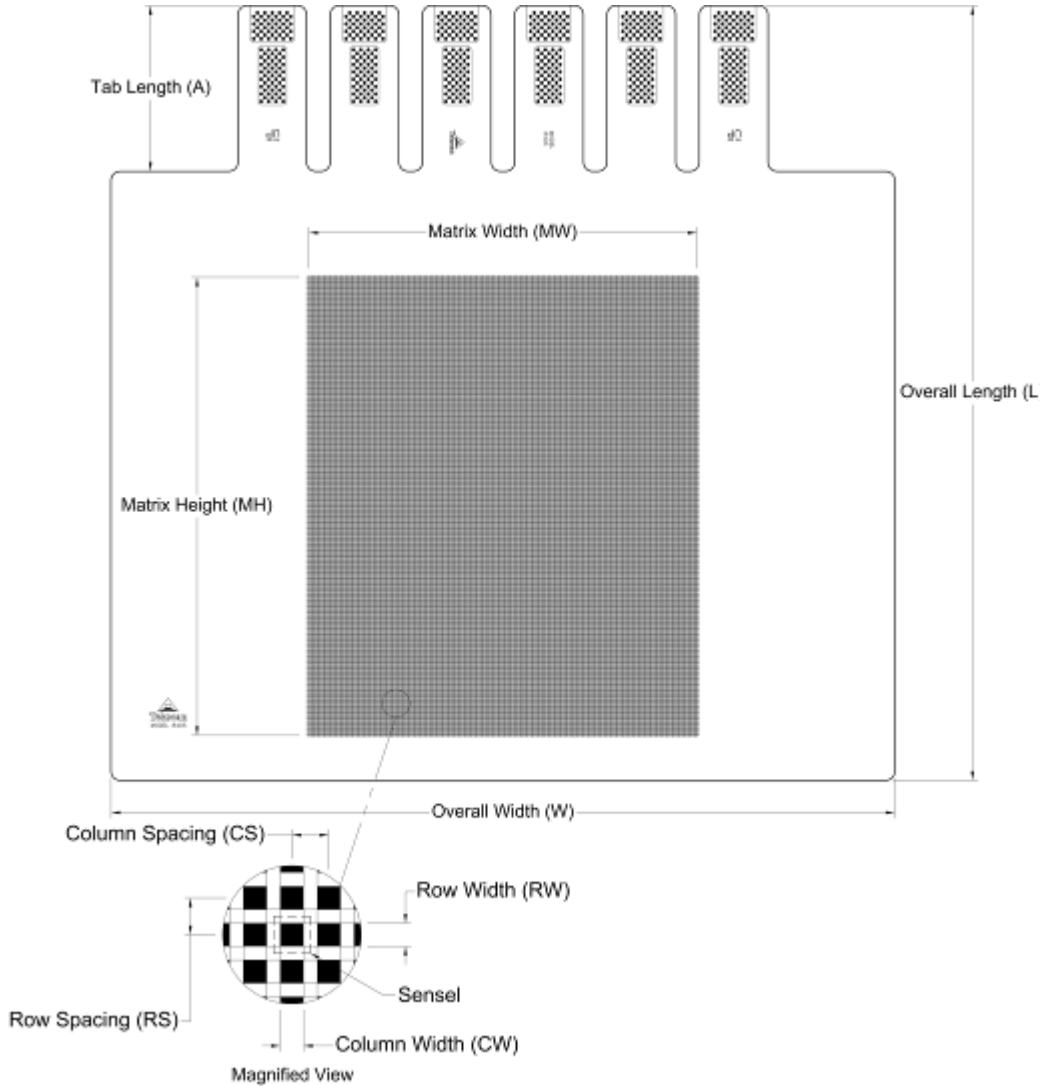

General Dimensions

Sensing Area Dimensions

Model	General Dimensions			Sensing Area Dimensions								Resolution	
	Overall Length L	Overall Width W	Tab Length A	Matrix Width MW	Matrix Height MH	Columns			Rows			Total No. of Sensels	Sensel Density
	(in.)	(in.)	(in.)	(in.)	(in.)	CW	Pitch CS	Qty.	RW	Pitch RS	Qty.		(sensel per sq. in.)
US 8405	21.00	21.20	4.50	10.56	12.48	0.015	0.040	264	0.015	0.040	312	82368	625.0
Metric 8405	(mm)	(mm)	(mm)	(mm)	(mm)	(mm)	(mm)		(mm)	(mm)			(sensel per sq. cm)
	533.4	538.5	114.3	268.2	317.0	0.4	1.0	264	0.4	1.0	312	82368	96.9

SENSOR MODEL: 8408

Application Example: Tire footprints

Requirement: 8 VersaTek® Handles

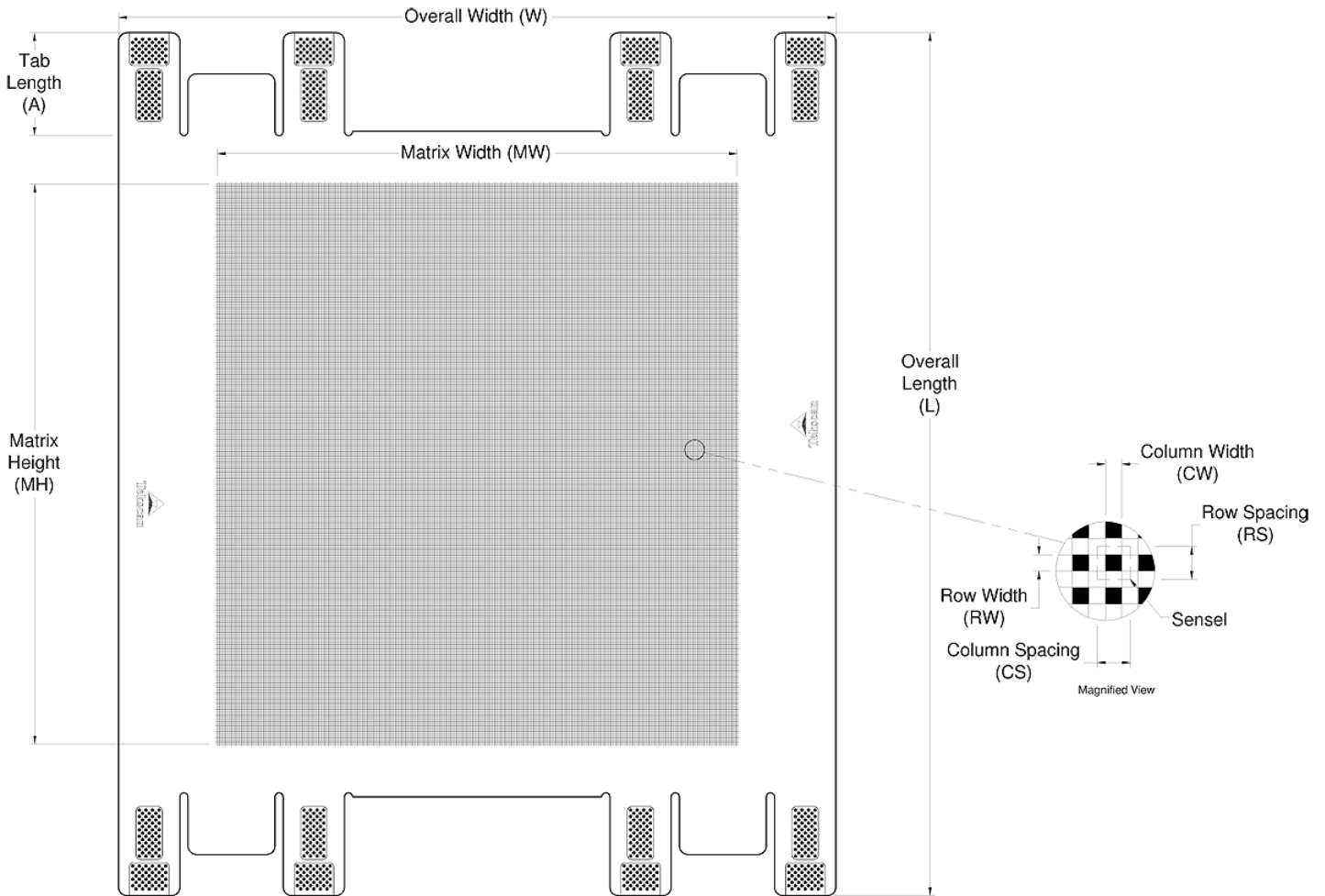

General Dimensions

Sensing Area Dimensions

Model	General Dimensions			Sensing Area Dimensions								Resolution	
	Overall Length L	Overall Width W	Tab Length A	Matrix Width MW	Matrix Height MH	Columns			Rows		Total No. of Sensels	Sensel Density	
	(in.)	(in.)	(in.)	(in.)	(in.)	Pitch	Qty.	RW	Pitch	Qty.			
US 8408	26.21	21.79	3.13	15.84	17.06	0.015	0.045	352	0.015	0.045	379	133408	(sensel per sq. in.) 493.8
Metric 8408	665.7	553.3	79.4	402.3	433.2	0.4	1.1	352	0.4	1.1	379	133408	(sensel per sq. cm) 76.5

SENSOR MODEL: 9500

Application Examples: Knee bolsters, head impacts to "A and B" pillars, airbag and car bumper impacts

Features:

- High-speed sensor
- Internal vents

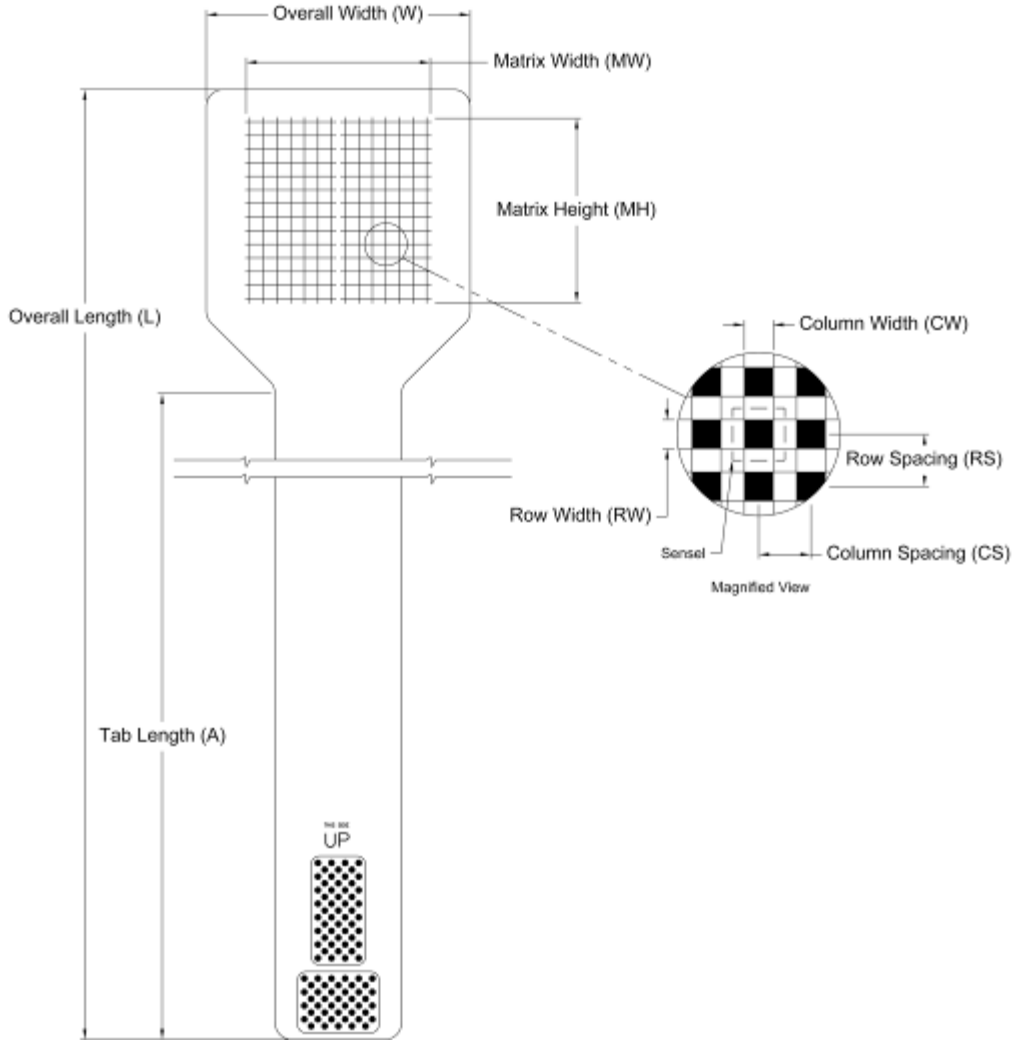

General Dimensions

Sensing Area Dimensions

Model	General Dimensions			Sensing Area Dimensions								Total No.of Sensels	Resolution Sensel Density
	Overall Length L	Overall Width W	Tab Length A	Matrix Width MW	Matrix Height MH	Columns			Rows				
	(in.)	(in.)	(in.)	(in.)	(in.)	CW	Pitch CS	Qty.	RW	Pitch RS	Qty.		(sensel per sq. in.)
US 9500	24.00	3.88	19.53	2.80	2.80	0.130	0.200	14	0.130	0.200	14	196	25.0
Metric 9500	(mm)	(mm)	(mm)	(mm)	(mm)	(mm)	(mm)	14	(mm)	(mm)	14	196	(sensel per sq. cm)
	609.6	98.7	496.0	71.1	71.1	3.3	5.1	14	3.3	5.1	14		3.9

SENSOR MODEL: 9550

Application Example: Head impacts to "A and B" pillars

Features:

- High-speed sensor
- Internal vents

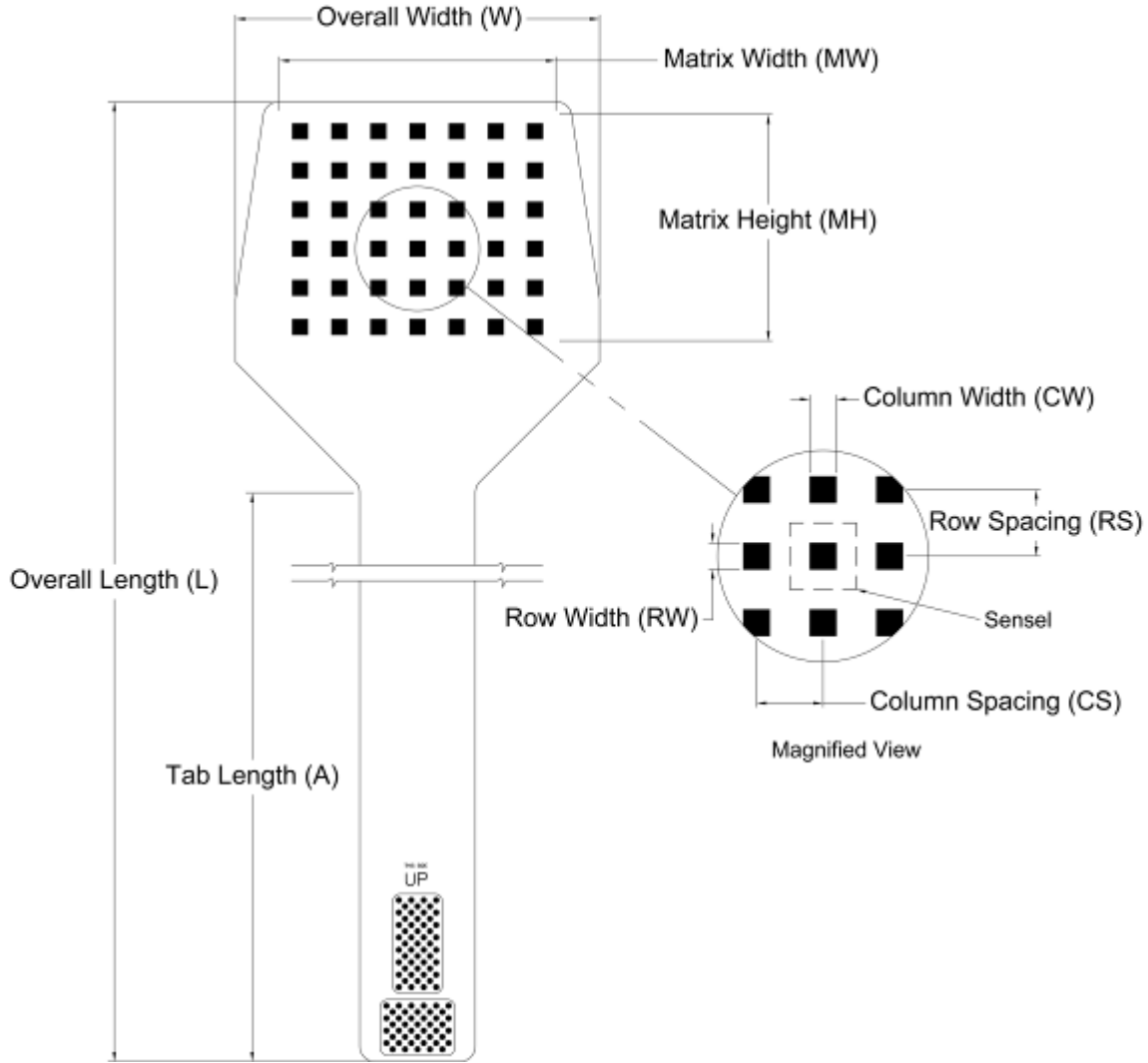

General Dimensions

Sensing Area Dimensions

Model	General Dimensions			Sensing Area Dimensions								Resolution	
	Overall Length L	Overall Width W	Tab Length A	Matrix Width MW	Matrix Height MH	Columns			Rows			Total No.of Sensels	Sensel Density
	(in.)	(in.)	(in.)	(in.)	(in.)	CW	Pitch CS	Qty.	RW	Pitch RS	Qty.		(sensel per sq. in.)
US 9550	18.03	5.86	11.73	4.41	3.78	0.280	0.630	7	0.280	0.630	6	42	2.5
Metric 9550	(mm)	(mm)	(mm)	(mm)	(mm)	(mm)	(mm)	7	(mm)	(mm)	6	42	(sensel per sq. cm)
	457.9	148.8	298.0	112.0	96.0	7.1	16.0	7	7.1	16.0	6		0.4

SENSOR MODEL: 9801

Application Examples: Prosthetic assessment, handgrips, clothing fit, diaper, and pressure garments

Features:

- Trimmable
- Can be slit into six independent strips of 16 sensing cells each
- External vents

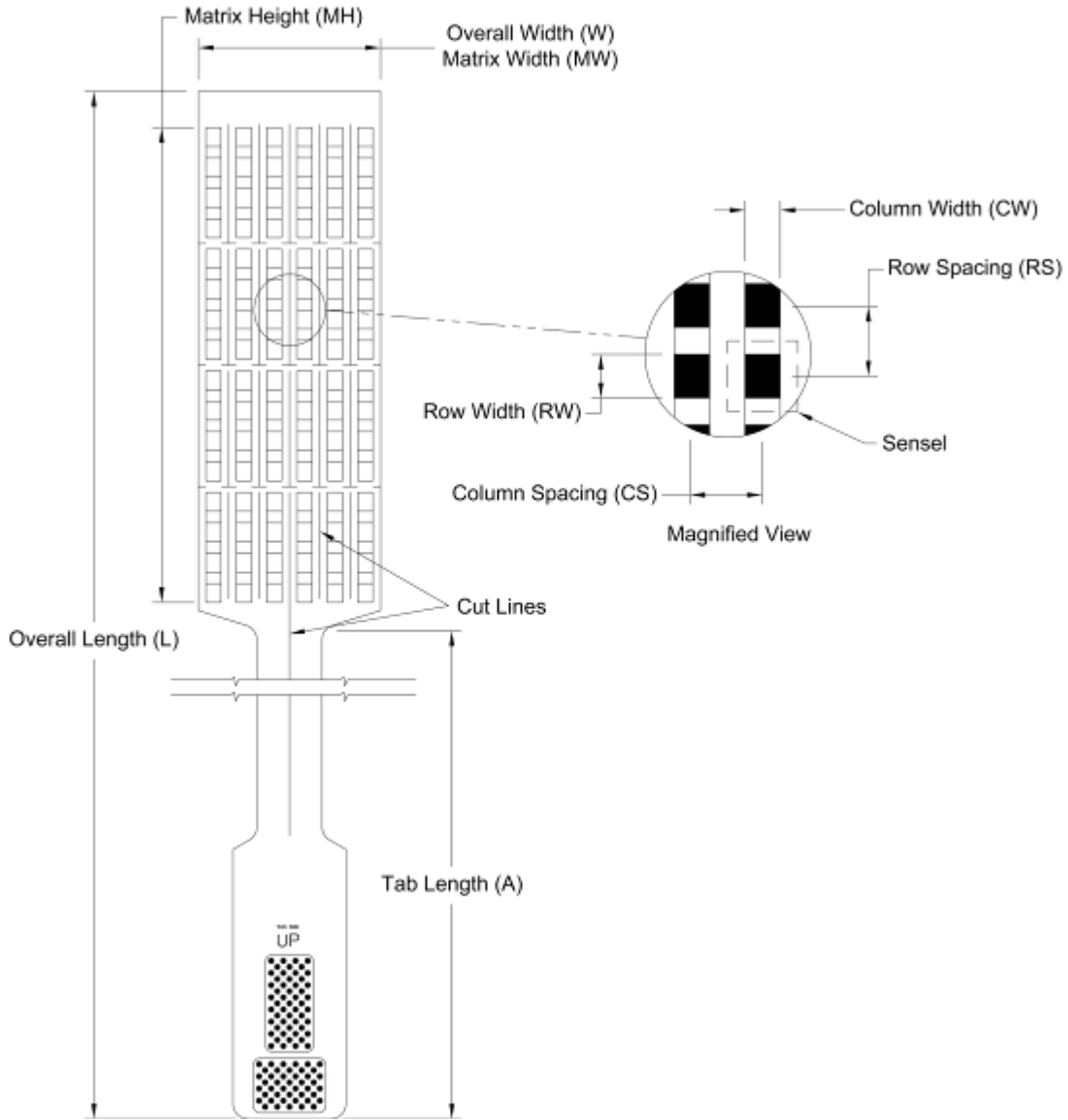

General Dimensions

Sensing Area Dimensions

Model	General Dimensions			Sensing Area Dimensions								Total No. of Sensels	Resolution Sensel Density
	Overall Length L	Overall Width W	Tab Length A	Matrix Width MW	Matrix Height MH	Columns			Rows				
	(in.)	(in.)	(in.)	(in.)	(in.)	CW	Pitch CS	Qty.	RW	Pitch RS	Qty.		(sensel per sq. in.)
US 9811	24.50	3.00	15.48	3.00	8.00	0.250	0.500	6	0.310	0.500	16	96	4.0
Metric 9811	622.3	76.2	393.2	76.2	203.2	6.4	12.7	6	7.9	12.7	16	96	0.6

SENSOR MODEL: 9830

Application Examples: Prosthetic assessment, handgrips, clothing fit, diaper, and pressure garments

Features:

- Can be slit into eleven independent sensing strips of 16 sensing cells each
- External vents

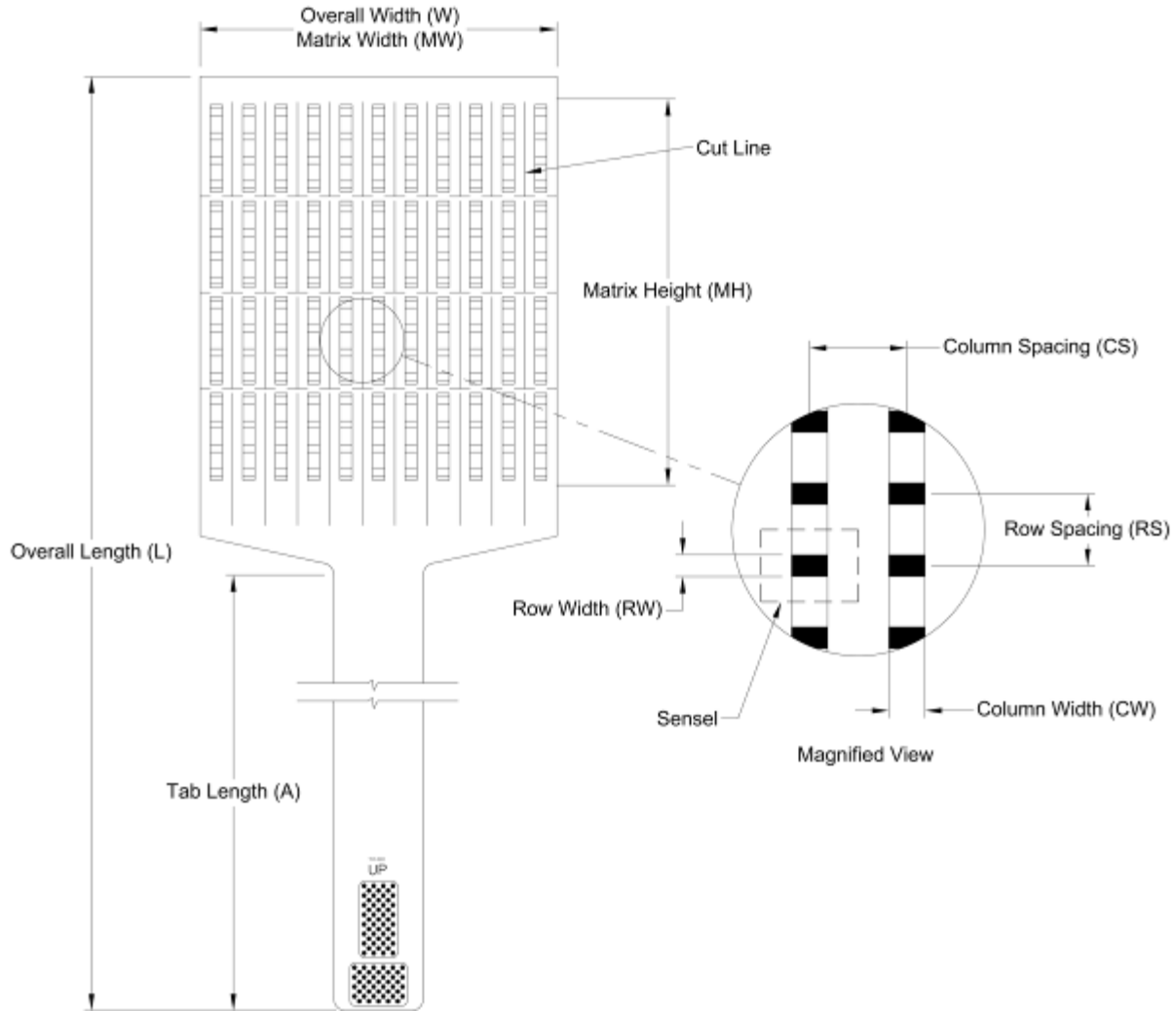

General Dimensions

Sensing Area Dimensions

Model	General Dimensions			Sensing Area Dimensions							Total No.of Sensels	Resolution
	Overall Length L	Overall Width W	Tab Length A	Matrix Width MW	Matrix Height MH	Columns			Rows			Sensel Density
	(in.)	(in.)	(in.)	(in.)	(in.)	CW	Pitch CS	Qty.	RW	Pitch RS	Qty.	(sensel per sq. in.)
US 9830	24.45	7.43	14.07	7.43	8.00	0.250	0.675	11	0.150	0.500	16	3.0
Metric 9830	621.0	188.6	357.4	188.6	203.2	6.4	17.1	11	3.8	12.7	16	0.5

SENSOR MODEL: 9850

Application Example: Brake pad to rotor interface pressures in auto, train, and aircraft brakes

Feature: Internal vents

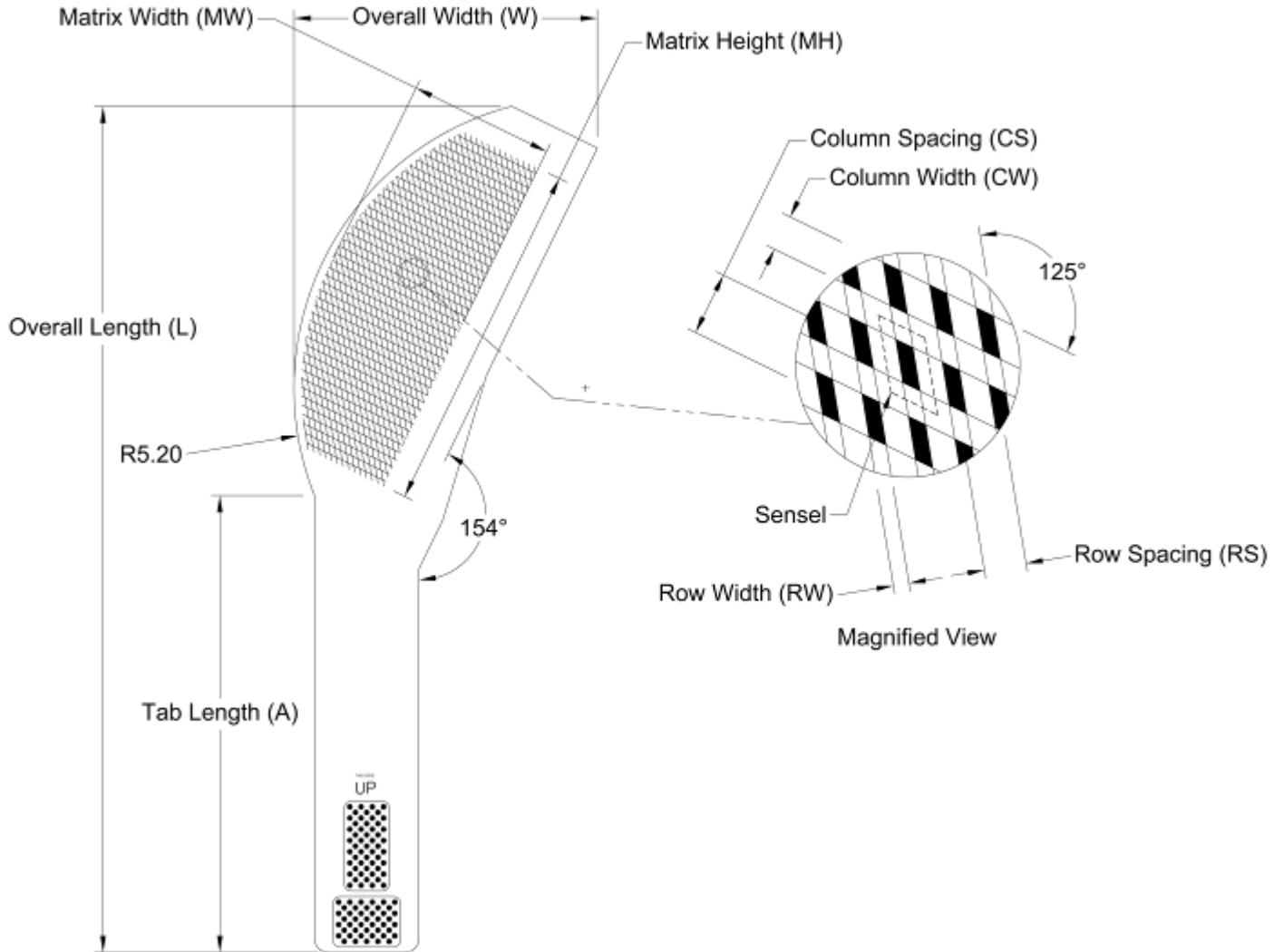

General Dimensions

Sensing Area Dimensions

Model	General Dimensions			Sensing Area Dimensions								Resolution Sensel Density	
	Overall Length L	Overall Width W	Tab Length A	Matrix Width MW	Matrix Height MH	Columns			Rows		Total No. of Sensels		
	(in.)	(in.)	(in.)	(in.)	(in.)	CW	Pitch CS	Qty.	RW	Pitch RS		Qty.	
US 9850	15.09	5.40	8.15	2.58	6.30	0.080	0.142	44	0.035	0.094	52	880	(sensel per sq. in.) 61.4
Metric 9850	383.4	137.2	207.1	65.5	160.0	2.0	3.6	44	0.9	2.4	52	880	(sensel per sq. cm) 9.5

SENSOR MODEL: 9851

Application Example: Brake pad to rotor interface pressures in auto, train, and aircraft brakes

Feature: Internal vents

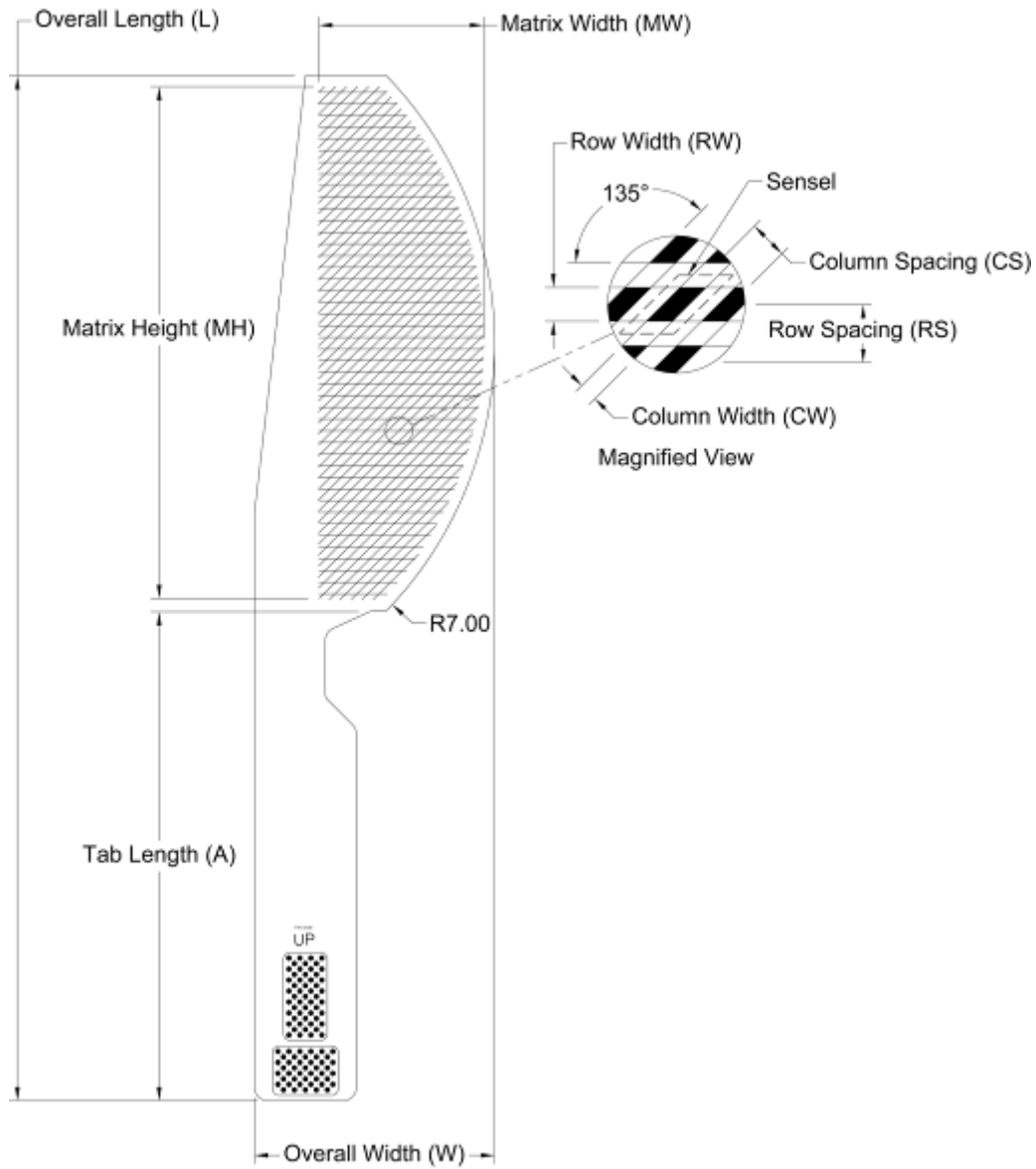

General Dimensions

Sensing Area Dimensions

Model	General Dimensions			Sensing Area Dimensions								Total No. of Sensels	Resolution Sensel Density
	Overall Length L	Overall Width W	Tab Length A	Matrix Width MW	Matrix Height MH	Columns			Rows				
						CW	Pitch CS	Qty.	RW	Pitch RS	Qty.		
US 9851	(in.) 18.67	(in.) 4.38	(in.) 8.93	(in.) 3.00	(in.) 9.33	(in.) 0.067	(in.) 0.142	52	(in.) 0.123	(in.) 0.212	44	489	(sensel per sq. in.) 23.5
Metric 9851	(mm) 474.2	(mm) 111.2	(mm) 226.8	(mm) 76.2	(mm) 237.0	(mm) 1.7	(mm) 3.6	52	(mm) 3.1	(mm) 5.4	44	489	(sensel per sq. cm) 3.6

SENSOR MODEL: 9855N/9856N/9857N

Application Example: Brake pad to rotor interface pressures

Feature: Smaller brake pads

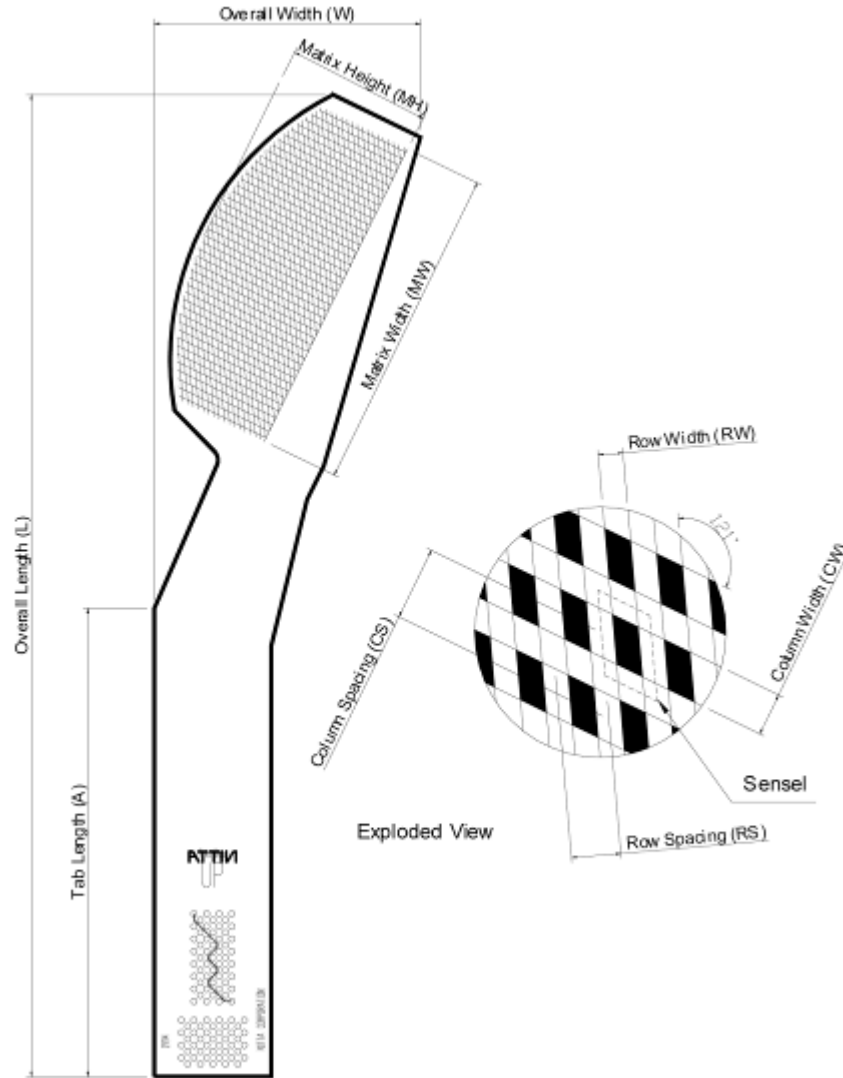

General Dimensions

Sensing Area Dimensions

Model	General Dimensions			Sensing Area Dimensions								Resolution	
	Overall Length L	Overall Width W	Tab Length A	Matrix Width MW	Matrix Height MH	Columns			Rows		Total No.of Sensels	Sensel Density	
						CW	Pitch CS	Qty.	RW	Pitch RS			Qty.
US	(in.)	(in.)	(in.)	(in.)	(in.)	(in.)	(in.)		(in.)	(in.)			(sensel per sq. in.)
9855N	14.72	3.61	7.48	4.33	1.77	0.059	0.098	44	0.030	0.080	24	1056	108.4
9856N	15.69	4.24	7.48	5.20	2.32	0.069	0.118	44	0.039	0.092	24	1056	79.1
9857N	16.61	4.66	9.21	6.18	2.64	0.069	0.141	44	0.039	0.093	52	856	63.6
Metric	(mm)	(mm)	(mm)	(mm)	(mm)	(mm)	(mm)		(mm)	(mm)			(sensel per sq. cm)
9855N	373.9	91.6	190.1	110.0	44.9	1.5	2.5	44	0.8	2.0	24	863	16.8
9856N	398.6	107.8	190.1	132.0	59.0	1.8	3.0	44	1.0	2.3	24	928	12.3
9857N	422.0	118.4	234.0	157.0	67.0	1.8	3.6	44	1.0	2.4	52	856	9.9

SENSOR MODEL: 9870

Application Examples: Torque converter and friction plate pressures

Features:

- Two sensors can be used to measure a circular friction plate.
- Internal vents

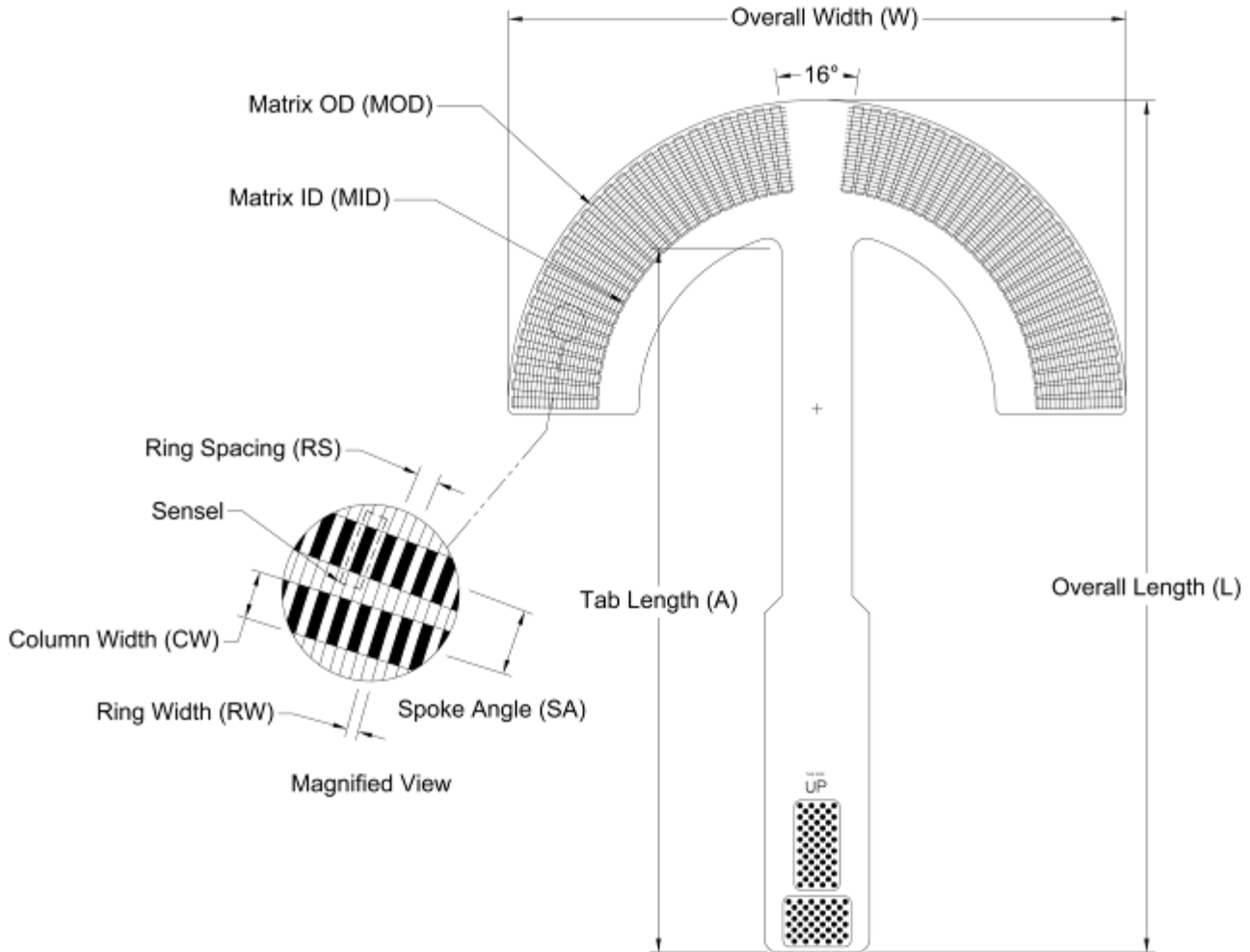

Model	General Dimensions			Sensing Area Dimensions								Summary		
	Overall Length L	Overall Width W	Tab Length A	Matrix ID MID	Matrix OD MOD	Spokes			Rings			Total No.of Sensels	Avg. Sensel Spatial Resolution	
	(in.)	(in.)	(in.)	(in.)	(in.)	SW	SA	Qty.	RW	RS	Qty.		(sensel per sq. in.)	
US 9870	15.08	10.91	12.40	7.80	10.71	0.170	3.240	52	0.040	0.077	20	1040	53.9	
Metric 9870	(mm)	(mm)	(mm)	(mm)	(mm)	(mm)	(mm)	(mm)	(mm)	(mm)	(mm)	(mm)	(mm)	(sensel per sq. cm)
	382.9	277.2	315.0	198.1	272.1	4.3	3.2	52	1.0	2.0	20	1040	8.4	

SENSOR MODEL: 9901

Application Examples:

- Windshield wiper blade pressure on glass
- Pressure under screen printer squeegee blades

Features:

- Can be used dynamically in wind tunnels
- Internal vents

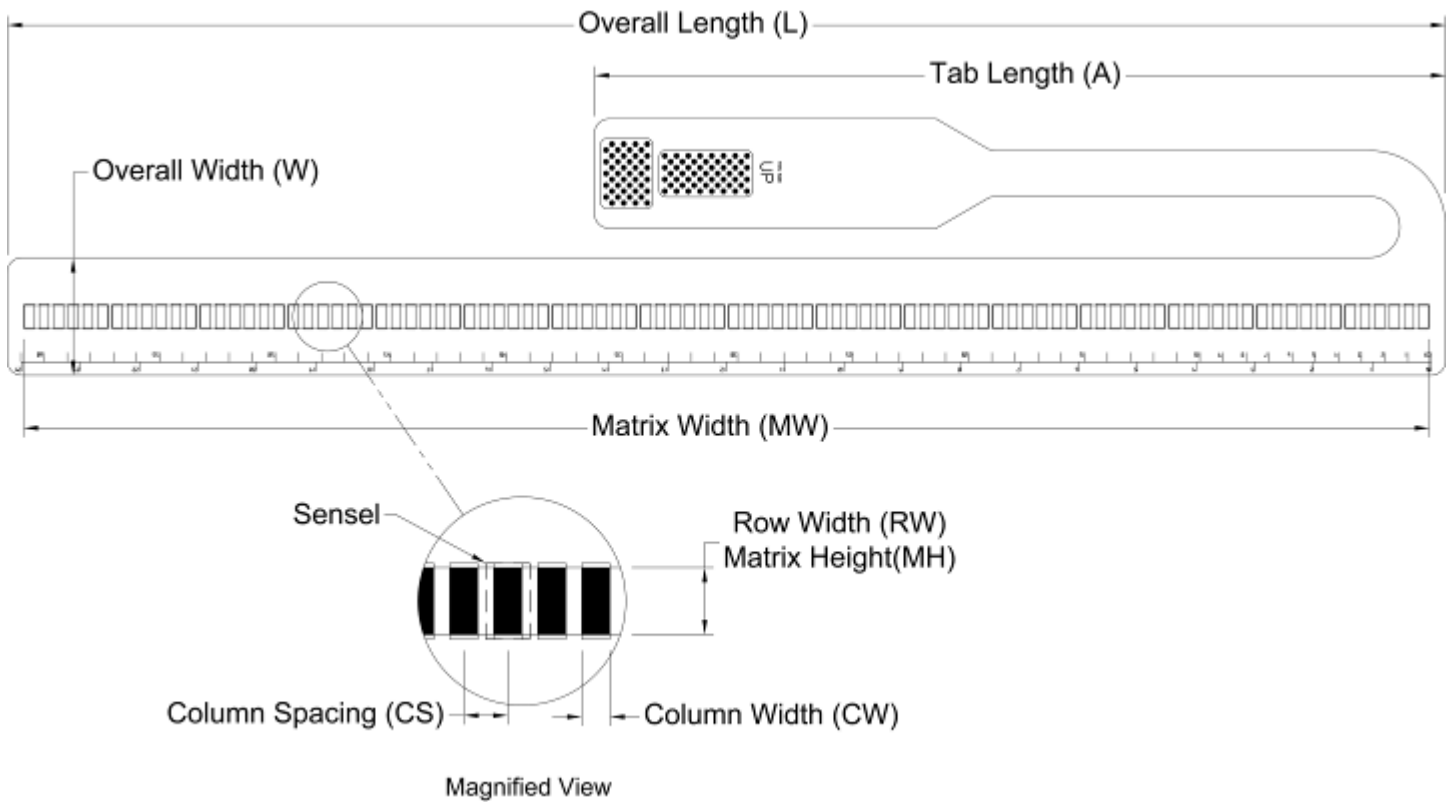

General Dimensions

Sensing Area Dimensions

Model	General Dimensions			Sensing Area Dimensions								Resolution	
	Overall Length L	Overall Width W	Tab Length A	Matrix Width MW	Matrix Height MH	Columns			Rows		Total No. of Sensels	Sensel Density	
						CW	CS	Qty.	RW	RS			Qty.
US 9901	(in.) 24.50	(in.) 2.00	(in.) 14.50	(in.) 24.00	(in.) 0.38	(in.) 0.160	(in.) 0.250	96	(in.) 0.380	(in.) 0.000	1	96	(sensel per sq. in.) 4.0
Metric 9901	(mm) 622.3	(mm) 50.8	(mm) 368.3	(mm) 609.6	(mm) 9.7	(mm) 4.1	(mm) 6.4	96	(mm) 9.7	(mm) 0.0	1	96	(sensel per sq. cm) 1.6

SENSOR MODEL: 9910

Application Example: Shoulder harness/seat belt

Features:

- Sensor can be cut along slit line to conform
- External vents

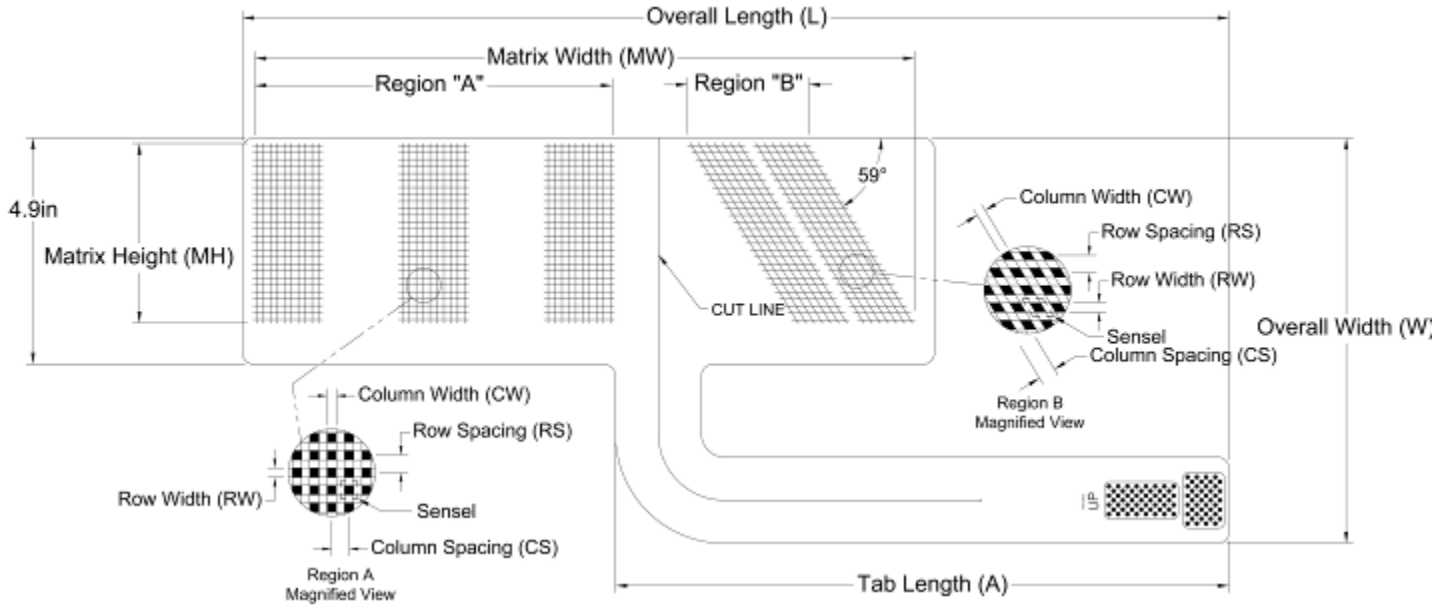

General Dimensions

Sensing Area Dimensions

Model	General Dimensions			Sensing Area Dimensions								Total No. of Sensels	Resolution				
	Overall Length L	Overall Width W	Tab Length A	Matrix Width MW	Matrix Height MH	Columns				Rows			Sensel Density				
	(in.)	(in.)	(in.)	(in.)	(in.)	CW	Pitch CS	Angle	Qty.	Qty.	RW		Pitch RS	Qty.	Reg A	Reg B	
US 9910	21.33	8.74	13.27	14.27	3.82	Reg A 0.080	Reg B 0.070	Reg B 0.150	59	30	14	(in.) 0.080	(in.) 0.150	26	1144	44.4	38.1
Metric 9910	541.8	222.0	337.0	362.5	97.0	(mm) 2.0	(mm) 1.8	(mm) 3.8	deg 59	30	14	(mm) 2.0	(mm) 3.8	26	1144	(sensel per sq. cm) 6.9	5.9

SENSOR MODEL: 9920

Application Example: Windshield wiper blades on glass

Features:

- Trimmable
- Conforms to curves
- External vents

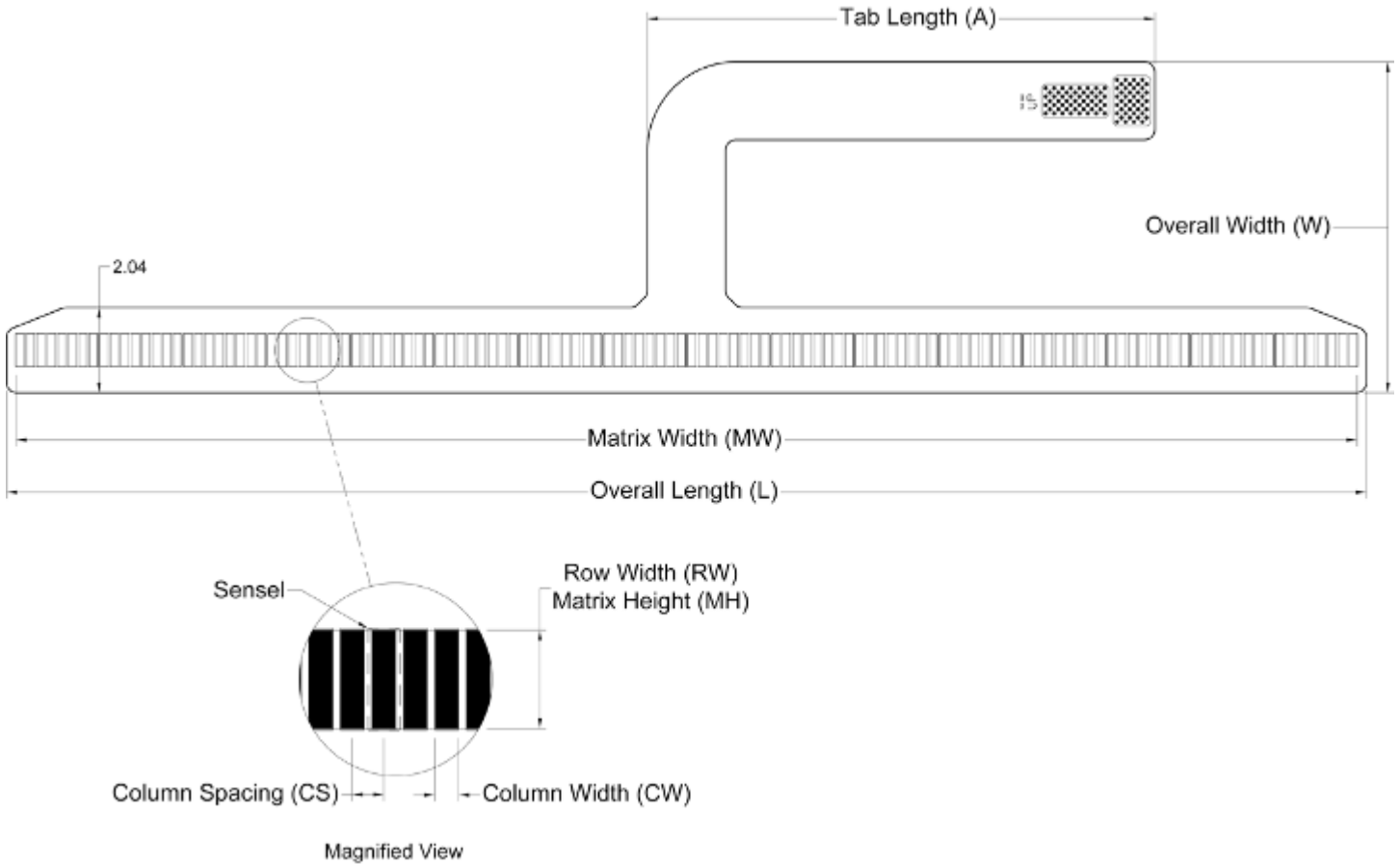

General Dimensions

Sensing Area Dimensions

Model	General Dimensions			Sensing Area Dimensions								Total No. of Sensels	Resolution Sensel Density
	Overall Length L	Overall Width W	Tab Length A	Matrix Width MW	Matrix Height MH	Columns			Rows				
						CW	CS	Qty.	RW	Pitch RS	Qty.		
US	(in.)	(in.)	(in.)	(in.)	(in.)	(in.)	(in.)		(in.)	(in.)			(sensel per sq. in.)
9920	32.39	7.90	12.09	32.00	0.77	0.170	0.250	128	0.767	0.000	1	128	4.0
Metric	(mm)	(mm)	(mm)	(mm)	(mm)	(mm)	(mm)		(mm)	(mm)			(sensel per sq. cm)
9920	822.7	200.6	307.0	812.8	19.5	4.3	6.4	128	19.5	0.0	1	128	1.6

Mattress

SENSOR MODEL: 5315

SENSOR MAP: 5315QL

Application Example: Mattress or support surface

Requirements:

- 4 Handles and (4) 5315 Sensors
- *BPMS™* software

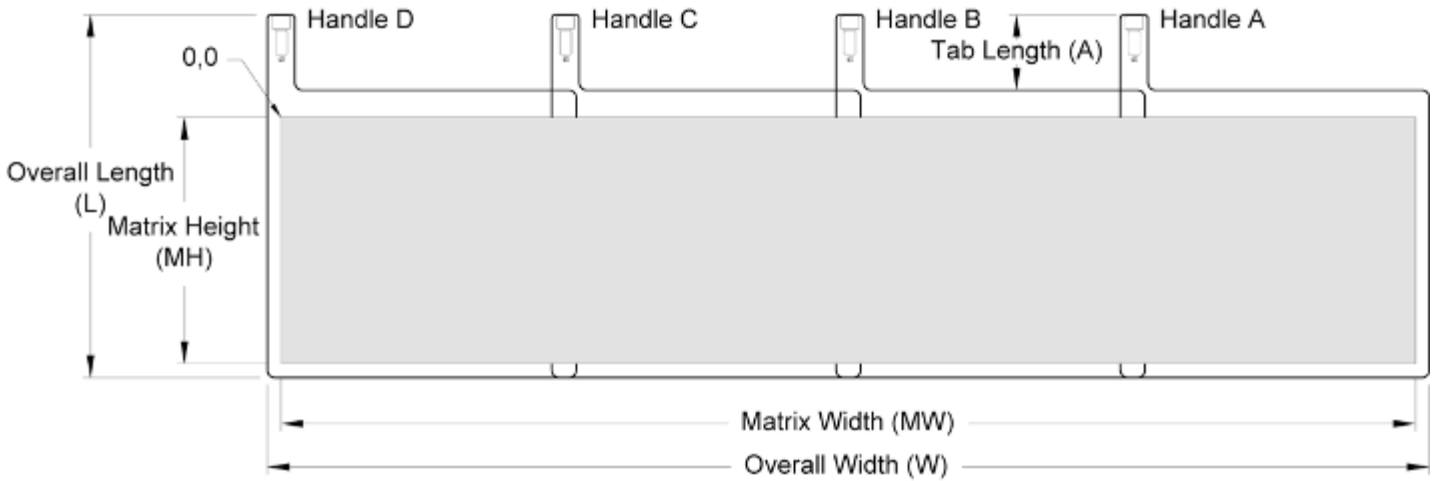

Model	General Dimensions					Sensing Area Dimensions						Total No.of Sensels	Resolution Sensel Density
	Overall Length	Overall Width	Tab Length	Matrix Width	Matrix Height	Columns			Rows				
	L	W	A	MW	MH	CW	Pitch CS	Qty.	RW	Pitch RS	Qty.		
US 5315QL	(in.) 24.50	(in.) 78.46	(in.) 5.15	(in.) 76.80	(in.) 16.80	(in.) 0.250	(in.) 0.400	192	(in.) 0.250	(in.) 0.400	42	8064	(sensel per sq. in.) 6.3
Metric 5315QL	(mm) 622.3	(mm) 1992.9	(mm) 130.9	(mm) 1950.7	(mm) 426.7	(mm) 6.4	(mm) 10.2	192	(mm) 6.4	(mm) 10.2	42	8064	(sensel per sq. cm) 1.0

SENSOR MODEL: 5315

SENSOR MAP: 5315O

Application Example: Mattress or support surface

Requirements:

- 8 Handles and (8) 5315 Sensors
- *BPMS™* software

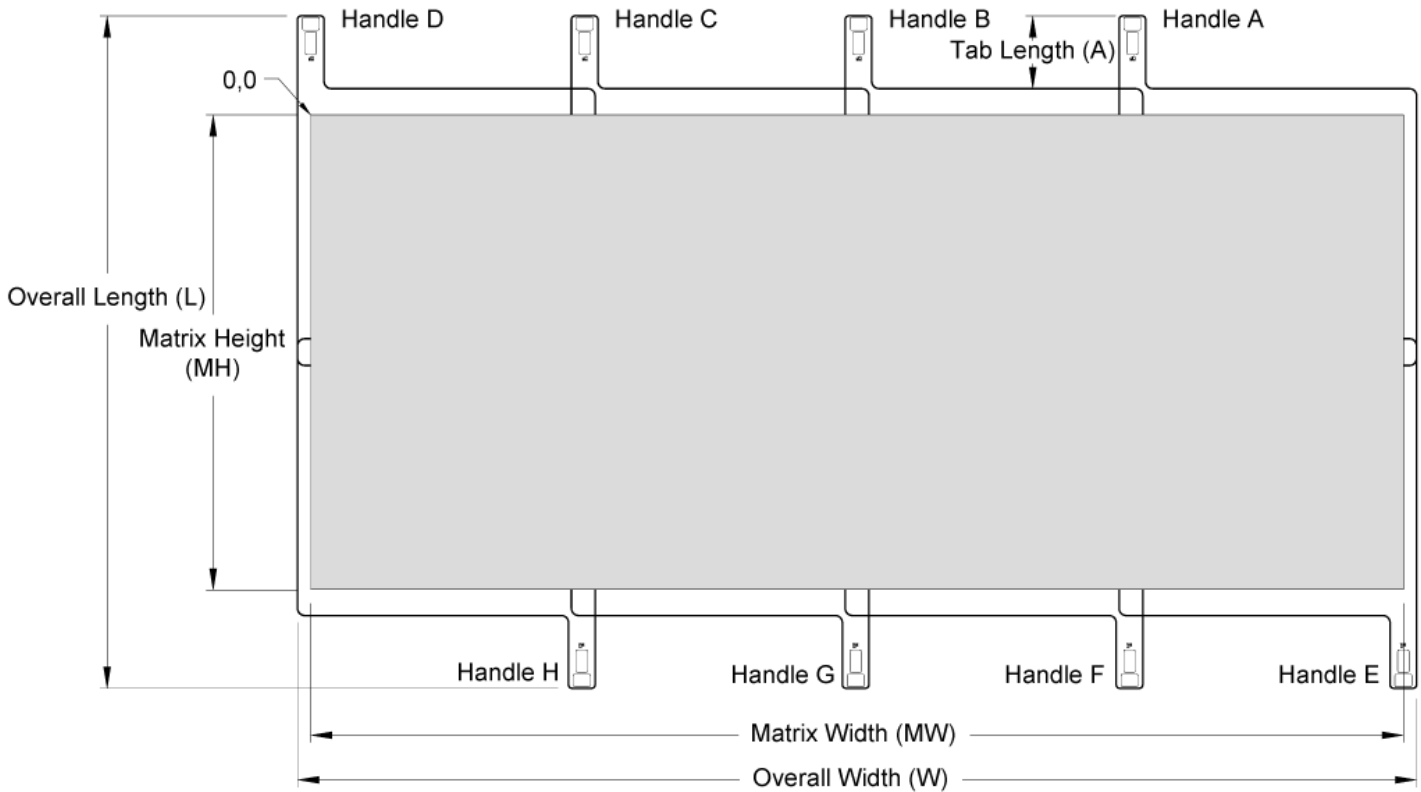

General Dimensions

Sensing Area Dimensions

Model	General Dimensions			Sensing Area Dimensions								Resolution	
	Overall Length L	Overall Width W	Tab Length A	Matrix Width MW	Matrix Height MH	Columns			Rows		Total No. of Senses		Sensel Density
US	(in.)	(in.)	(in.)	(in.)	(in.)	CW	Pitch CS	Qty.	RW	Pitch RS		Qty.	
5315O	47.02	78.46	5.15	76.80	33.60	0.250	0.400	192	0.250	0.400	84	16128	6.3
Metric 5315O	(mm)	(mm)	(mm)	(mm)	(mm)	(mm)	(mm)		(mm)	(mm)			(sensel per sq. cm)
	1194.3	1992.9	130.9	1950.7	853.4	6.4	10.2	192	6.4	10.2	84	16128	1.0

SENSOR MODEL: 5400N

SENSOR MAP: 5400ND

Application Example: Mattress or support surface

Requirements:

- 2 Handles and (2) 5400N Sensors
- *BPMS™* software



Model	General Dimensions				Sensing Area Dimensions							Total No. of Sensels	Resolution Sensel Density
	Overall Length	Overall Width	Tab Length	Matrix Width	Matrix Height	Columns			Rows				
	L	W	A	MW	MH	CW	Pitch CS	Qty.	RW	Pitch RS	Qty.		
US	(in.)	(in.)	(in.)	(in.)	(in.)	(in.)	(in.)		(in.)	(in.)			(sensel per sq. in.)
5400ND	82.62	25.20	4.72	22.76	69.61	0.394	0.669	34	0.394	0.669	104	3536	2.2
Metric	(mm)	(mm)	(mm)	(mm)	(mm)	(mm)	(mm)		(mm)	(mm)			(sensel per sq. cm)
5400ND	2098.5	640.1	119.9	578.0	1768.0	10.0	17.0	34	10.0	17.0	104	3536	0.3

SENSOR MODEL: 5400N

SENSOR MAP: 5400NTL

Application Example: Mattress or support surface

Requirements:

- 3 Handles and (3) 5400N Sensors
- *BPMS™* software

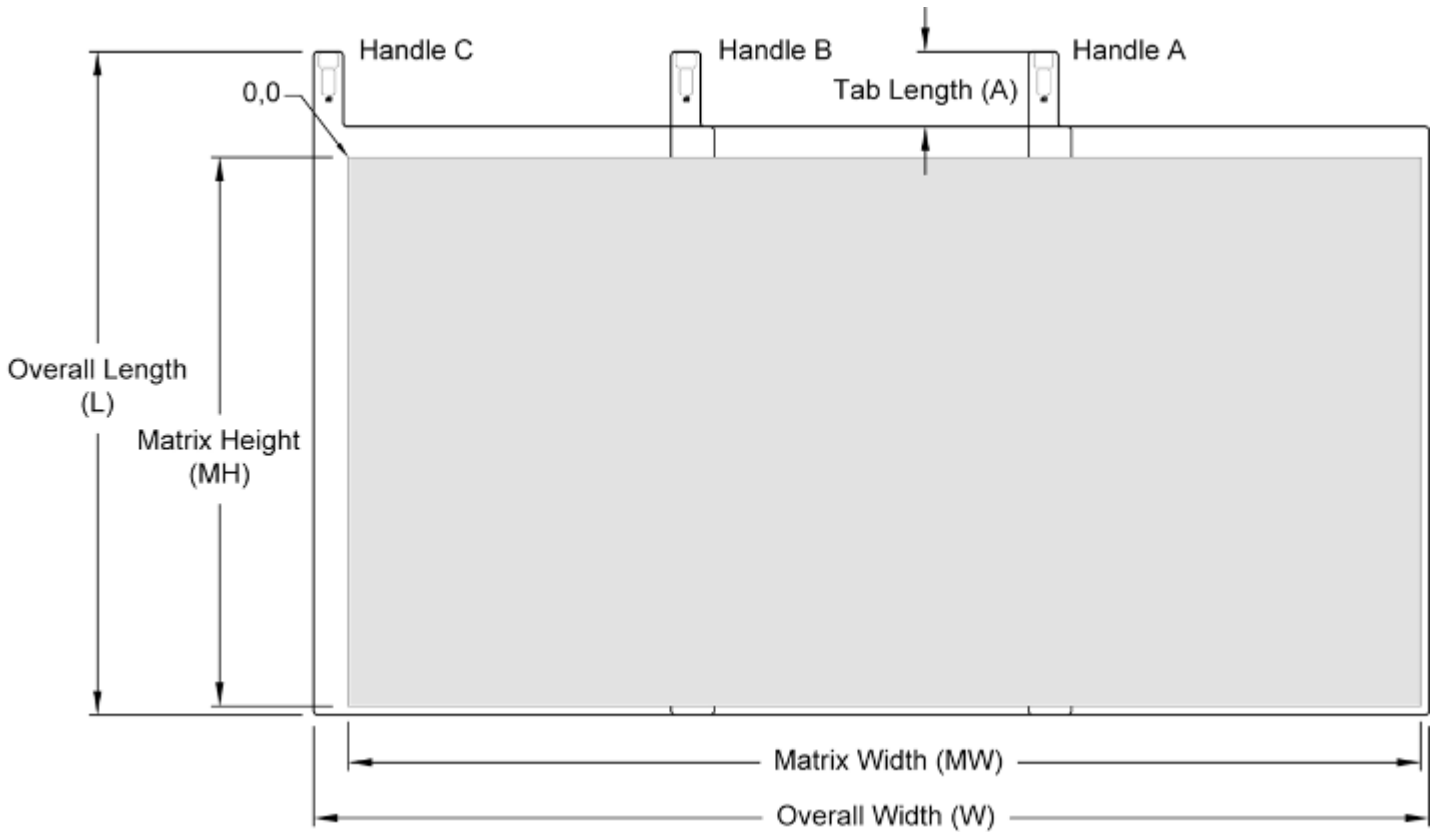

Model	General Dimensions					Sensing Area Dimensions						Total No. of Sensels	Resolution Sensel Density
	Overall Length L	Overall Width W	Tab Length A	Matrix Width MW	Matrix Height MH	Columns			Rows				
						CW	Pitch CS	Qty.	RW	Pitch RS	Qty.		
US 5400NTL	(in.) 41.73	(in.) 70.19	(in.) 4.72	(in.) 68.27	(in.) 34.80	(in.) 0.394	(in.) 0.669	102	(in.) 0.394	(in.) 0.669	52	5304	(sensel per sq. in.) 2.2
Metric 5400NTL	(mm) 1059.9	(mm) 1782.8	(mm) 119.9	(mm) 1734.0	(mm) 884.0	(mm) 10.0	(mm) 17.0	102	(mm) 10.0	(mm) 17.0	52	5304	(sensel per sq. cm) 0.3

SENSOR MODEL: 5400N

SENSOR MAP: 5400NQL

Application Example: Mattress or support surface

Requirements:

- 4 Handles and (4) 5400N Sensors
- *BPMS™* software

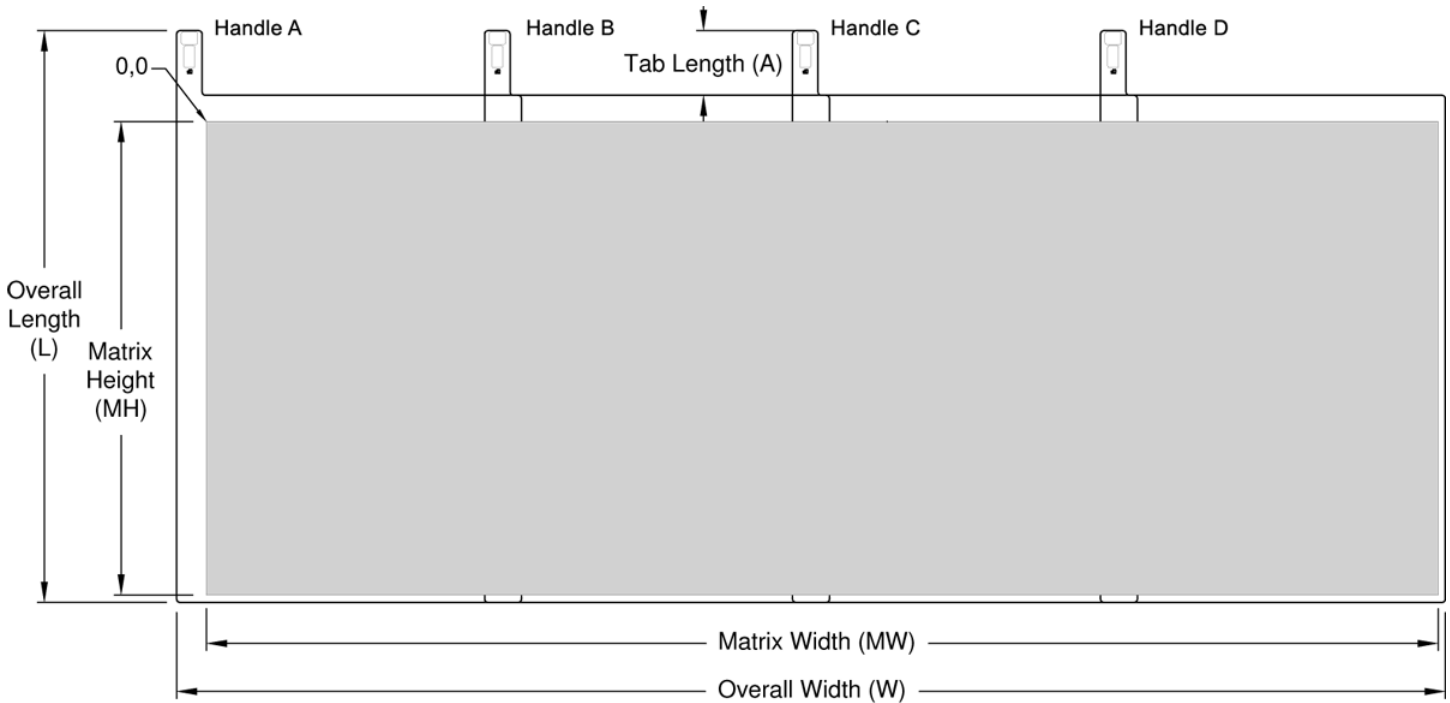

General Dimensions

Sensing Area Dimensions

Model	General Dimensions					Sensing Area Dimensions						Total No. of Sensels	Resolution Sensel Density	
	Overall Length	Overall Width	Tab Length	Matrix Width	Matrix Height	Columns			Rows					
	L	W	A	MW	MH	CW	Pitch CS	Qty.	RW	Pitch RS	Qty.			
US	(in.)	(in.)	(in.)	(in.)	(in.)	(in.)	(in.)		(in.)	(in.)				(sensel per sq. in.)
5400NQL	41.73	92.70	4.72	91.02	34.80	0.394	0.669	136	0.394	0.669	52	7072	2.2	
Metric	(mm)	(mm)	(mm)	(mm)	(mm)	(mm)	(mm)		(mm)	(mm)				(sensel per sq. cm)
5400NQL	1059.9	2354.6	119.9	2312.0	884.0	10.0	17.0	136	10.0	17.0	52	7072	0.3	

Seat

SENSOR MODEL: 5315/5350

Application Example: Pressure mapping and comfort studies of seats and cushions

Features:

- Sensor is covered with a flexible backing material to increase its durability
- Total thickness of 0.33mm (0.012”) includes flexible backing on both sides of sensor; thinner construction may be available
- External vents

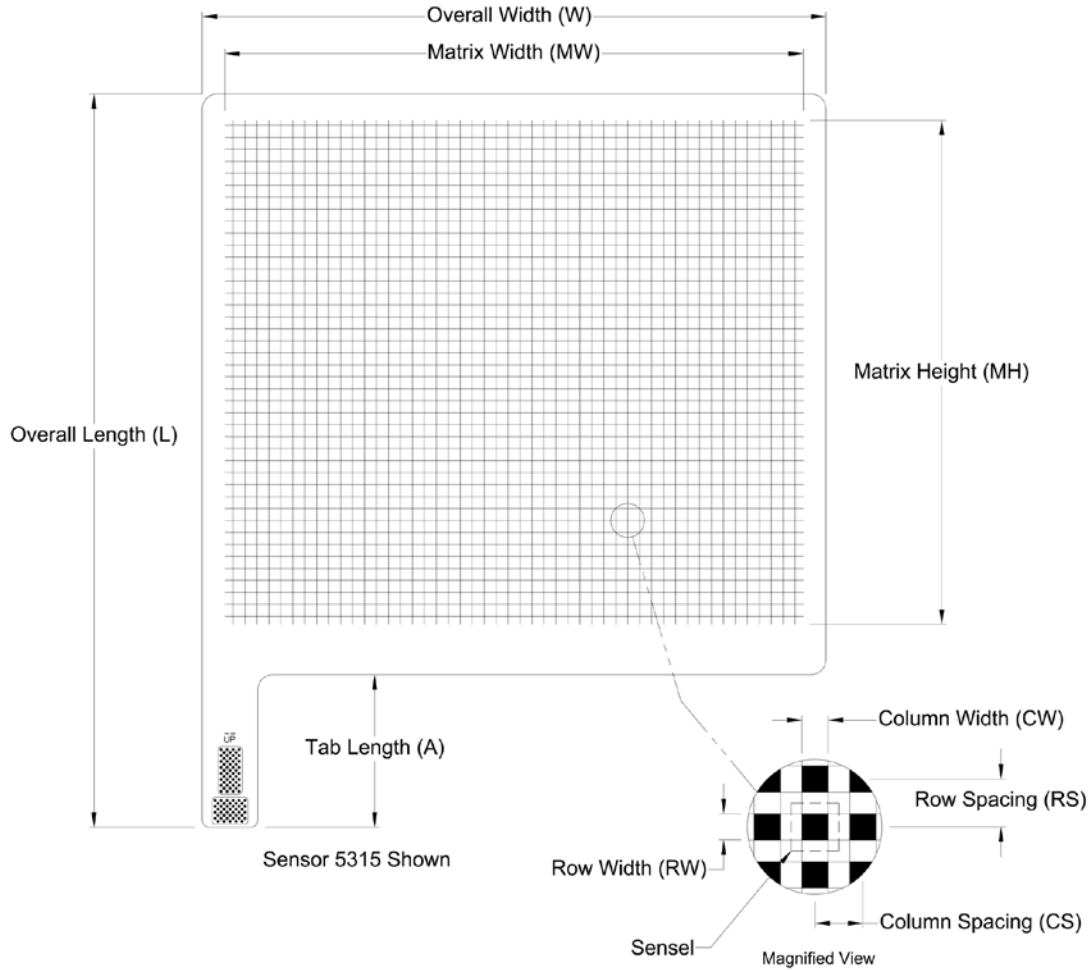

General Dimensions

Sensing Area Dimensions

Model	General Dimensions			Sensing Area Dimensions								Total No. of Sensels	Resolution Sensel Density
	Overall Length L	Overall Width W	Tab Length A	Matrix Width MW	Matrix Height MH	Columns			Rows				
	(in.)	(in.)	(in.)	(in.)	(in.)	CW	Pitch CS	Qty.	RW	Pitch RS	Qty.		(sensel per sq. in.)
US 5315	24.50	20.86	5.15	19.20	16.80	0.250	0.400	48	0.250	0.400	42	2016	6.3
5350	24.00	18.06	6.61	16.40	15.20	0.250	0.400	41	0.250	0.400	38	1558	6.3
Metric 5315	(mm)	(mm)	(mm)	(mm)	(mm)	(mm)	(mm)		(mm)	(mm)			(sensel per sq. cm)
5350	622.3	529.8	130.9	487.7	426.7	6.4	10.2	48	6.4	10.2	42	2016	1.0
	609.6	458.7	167.9	416.6	386.1	6.4	10.2	41	6.4	10.2	38	1558	1.0

SENSOR MODEL: 5330

SENSOR NAME: *CONFORMAT*[®]

Application Example: Pressure mapping and comfort studies of seats and cushions

Features:

- Fully conforming sensor; sensor elements move freely in the X, Y, and Z axis
- Minimal interference with the client/support surface interface

Requirement: *CONFORMat* or *BPMS*[™] software

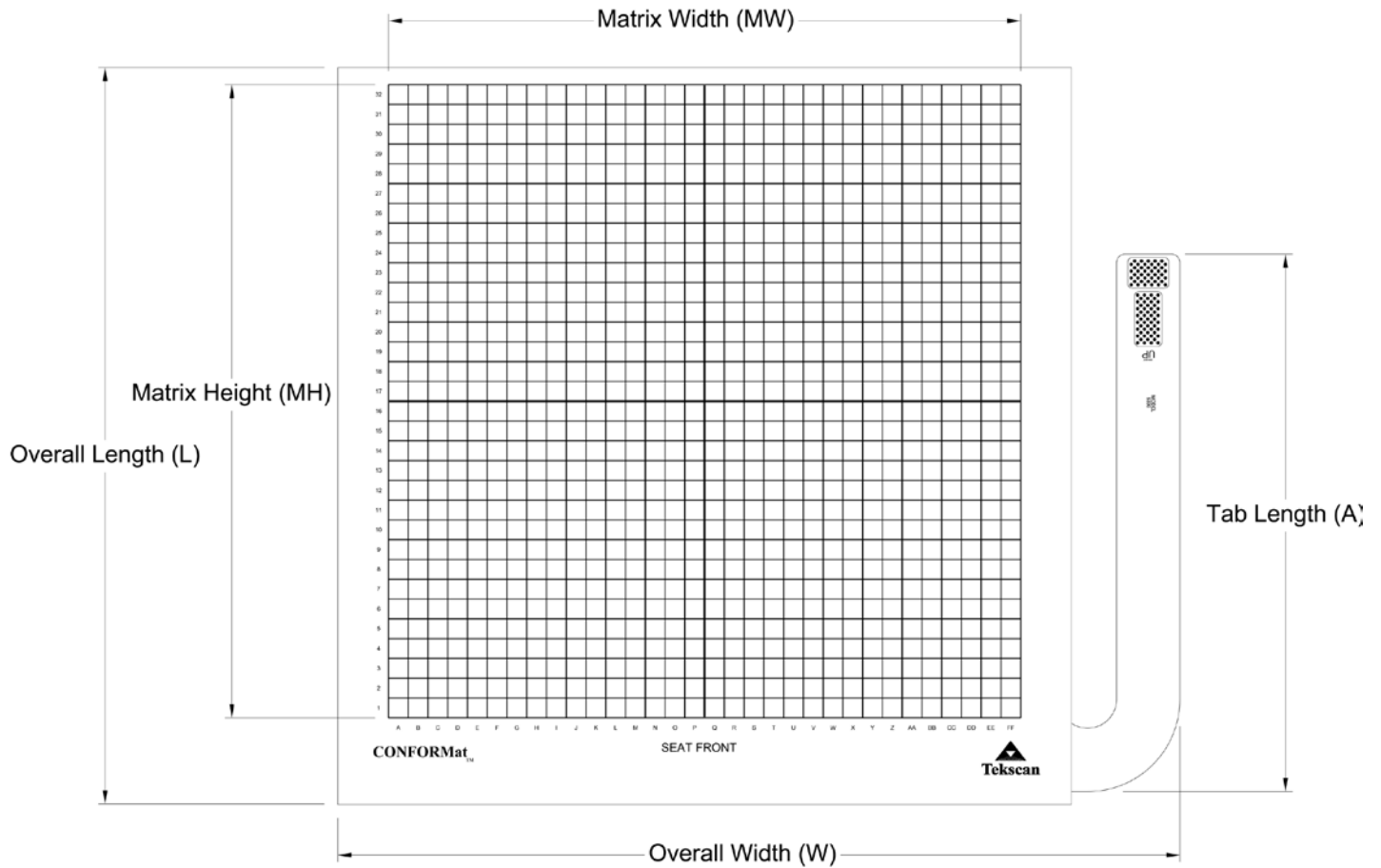

General Dimensions

Sensing Area Dimensions

Model	Overall Length L	Overall Width W	Tab Length A	Matrix Width MW	Matrix Height MH	Columns			Rows			Total No. of Sensels	Resolution Sensel Density
						CW	Pitch CS	Qty.	RW	Pitch RS	Qty.		
US 5330	(in.) 21.23	(in.) 24.35	(in.) 15.76	(in.) 18.56	(in.) 18.56	(in.) 0.000	(in.) 0.580	32	(in.) 0.000	(in.) 0.580	32	1024	(sensel per sq. in.) 3.0
Metric 5330	(mm) 539.2	(mm) 618.4	(mm) 400.3	(mm) 471.4	(mm) 471.4	(mm) 0.0	(mm) 14.7	32	(mm) 0.0	(mm) 14.7	32	1024	(sensel per sq. cm) 0.5

SENSOR MODEL: 5330

SENSOR MAP: 5330D

Application Examples:

- Seating and positioning
- Mattress or support surface

Requirements:

- 2 Handles and (2) 5330 Sensors
- *CONFORMat* or *BPMS™* software

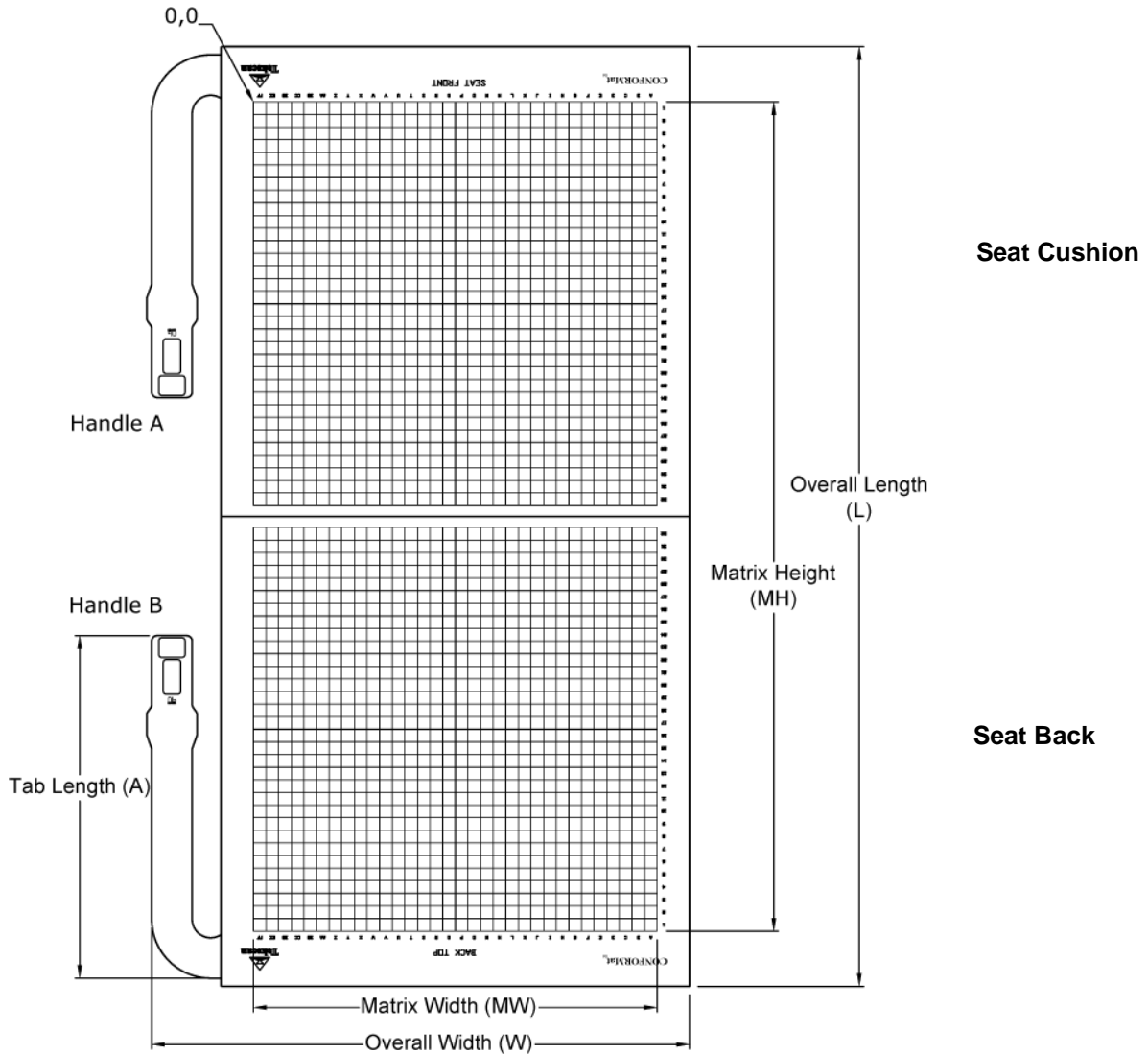

General Dimensions

Sensing Area Dimensions

Model	General Dimensions			Sensing Area Dimensions			Sensing Area Dimensions			Total No. of Sensels	Resolution		
	Overall Length L	Overall Width W	Tab Length A	Matrix Width MW	Matrix Height MH	Columns	Rows						
US	(in.)	(in.)	(in.)	(in.)	(in.)	CW	Pitch CS	Qty.	RW	Pitch RS	Qty.	Sensel Density	
5330D	43.21	24.35	15.76	18.56	38.13	N/A	0.580	32	N/A	0.580	64	2048	(sensel per sq. in.) 3.0
Metric	(mm)	(mm)	(mm)	(mm)	(mm)	(mm)	(mm)		(mm)	(mm)			(sensel per sq. cm)
5330D	1097.5	618.5	400.3	471.4	968.5	N/A	14.7	32	N/A	14.7	64	2048	0.5

SENSOR MODEL: 5400N

SENSOR NAME: *HUGE-MAT*TM

Application Example: Ergonomic and comfort studies of seats

Features:

- Sensor is covered with a flexible backing material to increase its durability; total thickness of 0.33mm (0.012") includes flexible backing on both sides of sensor; thinner construction may be available
- Also available with protective platform for foot and hoof applications

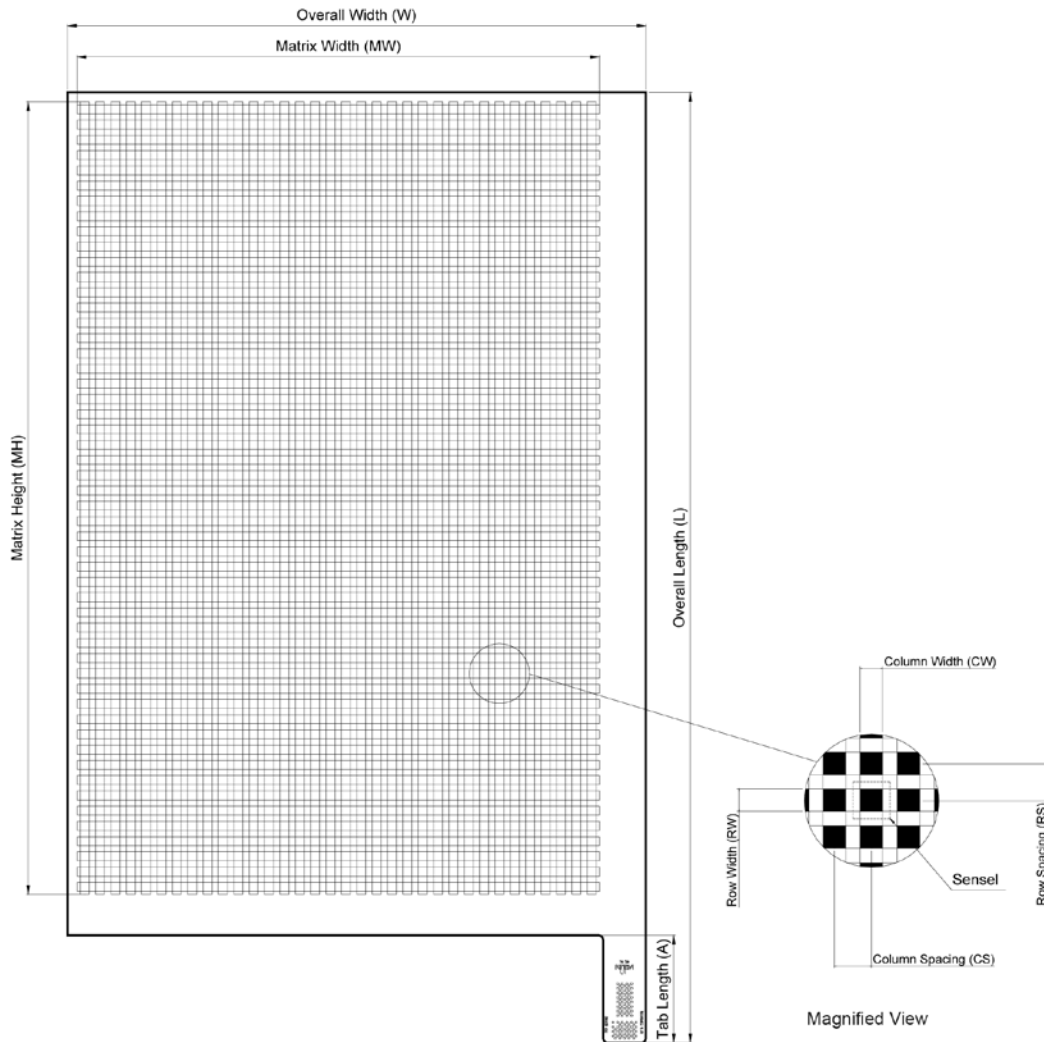

Model	General Dimensions					Sensing Area Dimensions						Total No. of Sensels	Resolution Sensel Density
	Overall Length L	Overall Width W	Tab Length A	Matrix Width MW	Matrix Height MH	Columns			Rows				
						CW	Pitch CS	Qty.	RW	Pitch RS	Qty.		
US	(in.)	(in.)	(in.)	(in.)	(in.)	(in.)	(in.)		(in.)	(in.)			(sensel per sq. in.)
5350N	22.83	21.02	12.8	17.32	18.90	0.236	0.394	44	0.236	0.394	48	2112	6.5
Metric	(mm)	(mm)	(mm)	(mm)	(mm)	(mm)	(mm)		(mm)	(mm)			(sensel per sq. cm)

Tire

SENSOR MODEL: 3150

SENSOR MAP: 3150Q

Application Example: Tire footprints

Requirement: 4 VersaTek® Handles and (4) 3150 Sensors

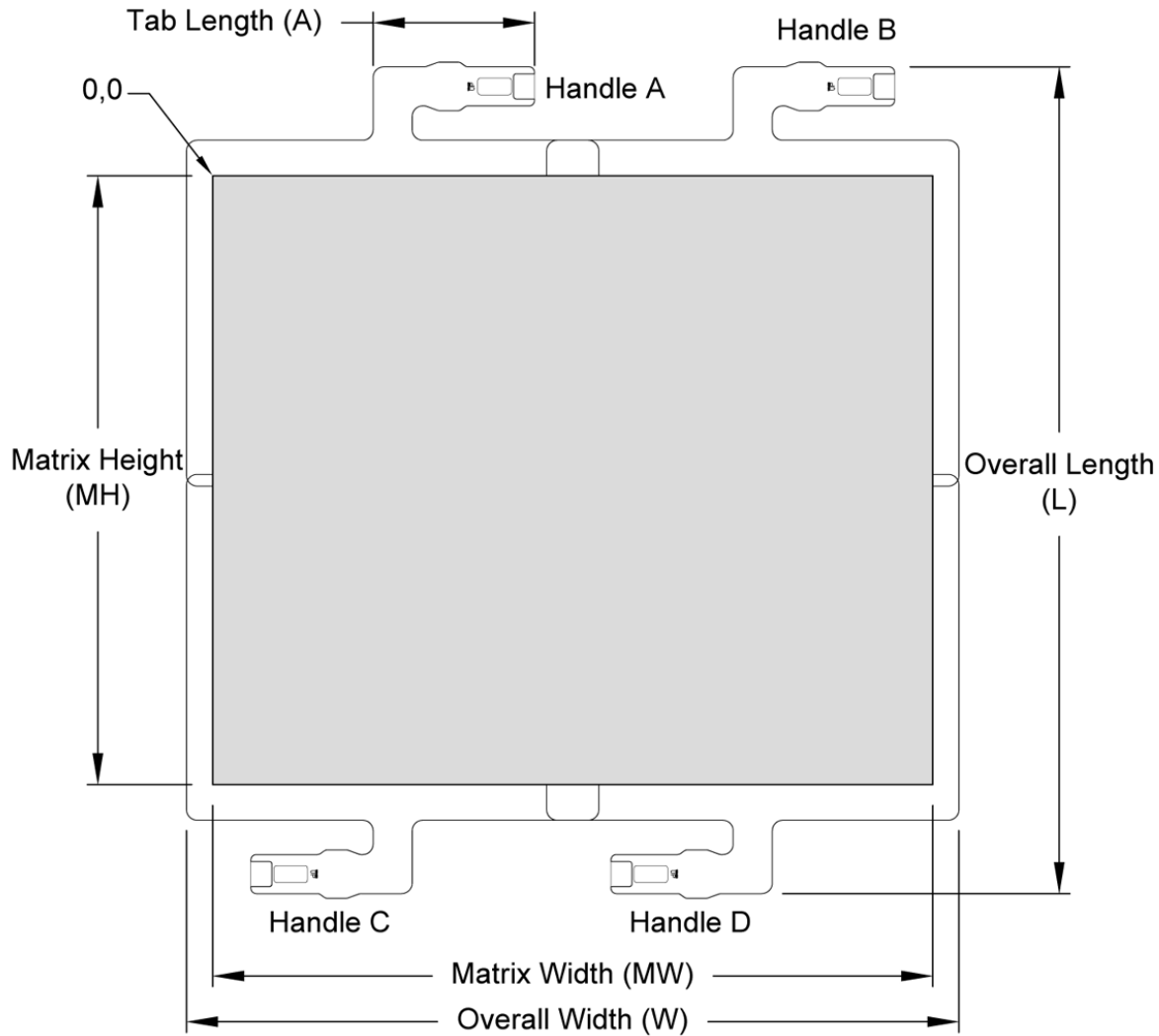

General Dimensions

Sensing Area Dimensions

Model	General Dimensions			Sensing Area Dimensions								Resolution	
	Overall Length L	Overall Width W	Tab Length A	Matrix Width MW	Matrix Height MH	Columns			Rows		Total No. of Senses		Sensel Density
US	(in.)	(in.)	(in.)	(in.)	(in.)	CW	CS	Qty.	RW	RS		Qty.	
3150Q	39.44	36.81	7.68	34.32	29.04	0.230	0.330	104	0.230	0.330	88	9152	9.2
Metric	(mm)	(mm)	(mm)	(mm)	(mm)	(mm)	(mm)		(mm)	(mm)		(sensel per sq. cm)	
3150Q	1001.8	935.0	195.1	871.7	737.6	5.8	8.4	104	5.8	8.4	88	9152	1.4

SENSOR MODEL: 3150

SENSOR MAP: 3150H

Application Example: Tire footprints

Special Features: 6 VersaTek® Handles and (6) 3150 Sensors

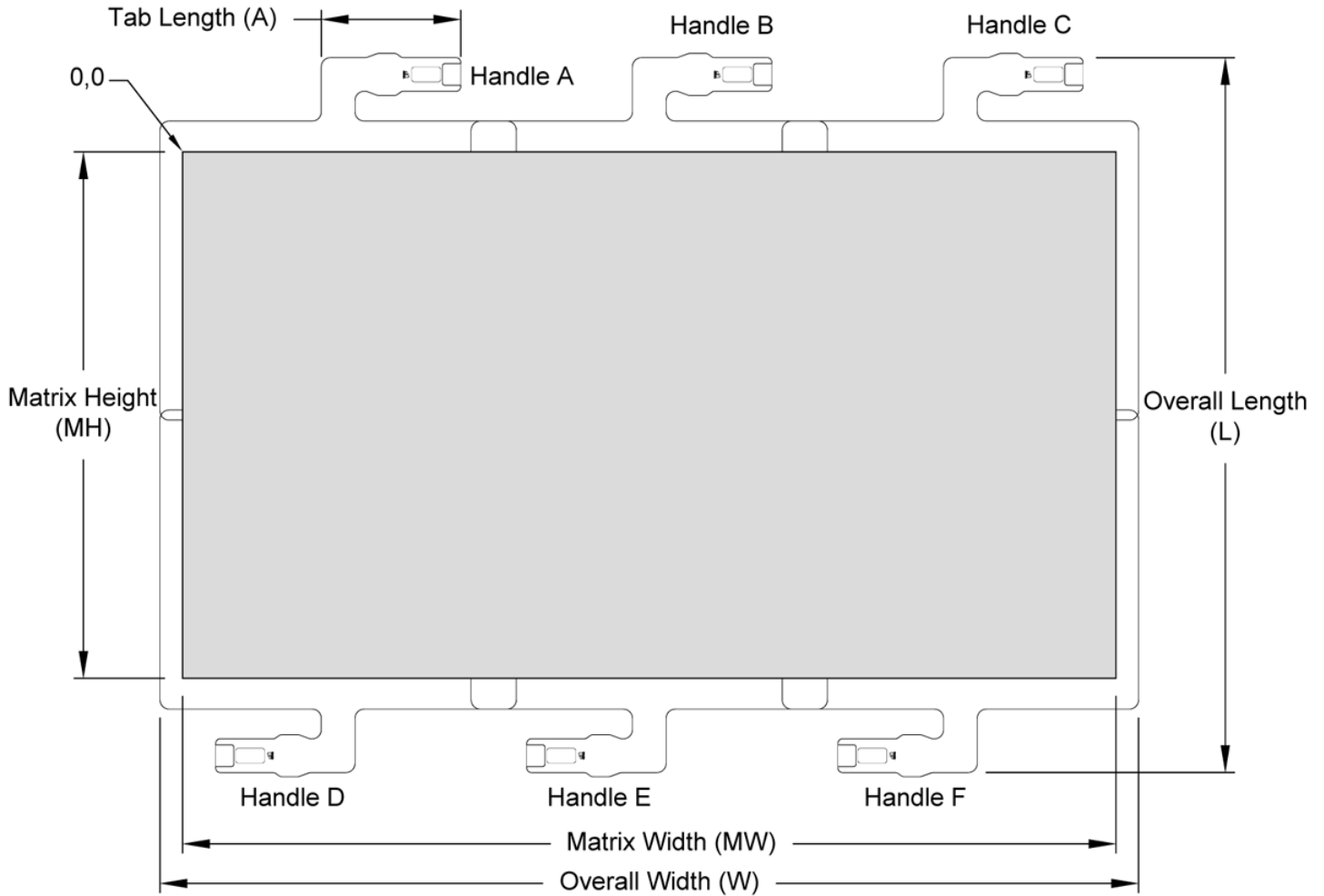

General Dimensions

Sensing Area Dimensions

Model	General Dimensions			Sensing Area Dimensions								Resolution	
	Overall Length L	Overall Width W	Tab Length A	Matrix Width MW	Matrix Height MH	Columns			Rows		Total No. of Senses		Sensel Density
US	(in.)	(in.)	(in.)	(in.)	(in.)	CW	Pitch CS	Qty.	RW	Pitch RS		Qty.	
3150H	39.44	53.97	7.68	51.48	29.04	0.230	0.330	156	0.230	0.330	88	13728	9.2
Metric	(mm)	(mm)	(mm)	(mm)	(mm)	(mm)	(mm)		(mm)	(mm)		(sensel per sq. cm)	
3150H	1001.8	1370.8	195.1	1307.6	737.6	5.8	8.4	156	5.8	8.4	88	13728	1.4

SENSOR MODEL: 5400N

SENSOR MAP: 5400NQ

Application Example: Tire footprints

Requirement: 4 Handles and (4) 5400N Sensors

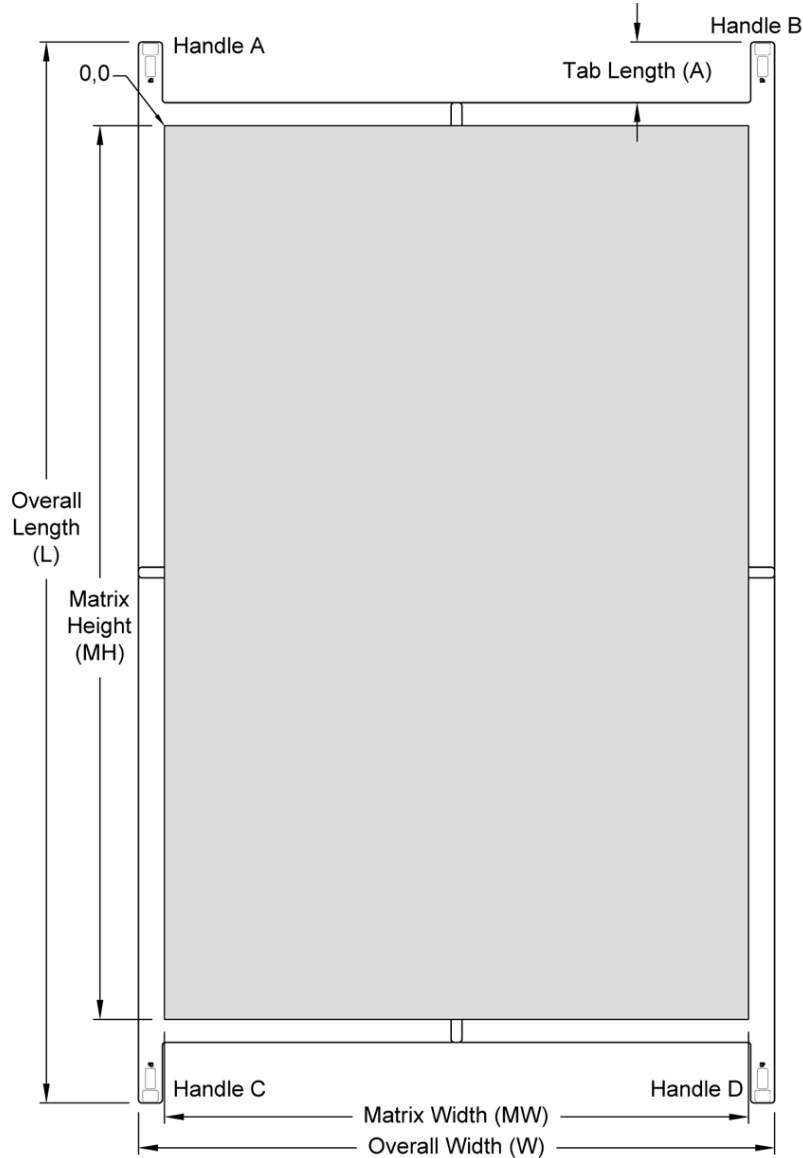

General Dimensions

Sensing Area Dimensions

Model	General Dimensions		Sensing Area Dimensions		Columns			Rows			Total No. of Sensels	Resolution Sensel Density	
	Overall Length L	Overall Width W	Tab Length A	Matrix Width MW	Matrix Height MH	CW	Pitch CS	Qty.	RW	Pitch RS			Qty.
US	(in.)	(in.)	(in.)	(in.)	(in.)	(in.)	(in.)		(in.)	(in.)		(sensel per sq. in.)	
5400NQ	82.62	47.95	4.72	45.51	69.61	0.394	0.669	68	0.394	0.669	104	7072	2.2
Metric	(mm)	(mm)	(mm)	(mm)	(mm)	(mm)	(mm)		(mm)	(mm)		(sensel per sq. cm)	
5400NQ	2098.5	1217.9	119.9	1156.0	1768.0	10.0	17.0	68	11.0	17.0	104	7072	0.3

SENSOR MODEL: 5400N

SENSOR MAP: 5400NH

Application Example: Tire footprints

Requirement: 6 Handles and (6) 5400N Sensors

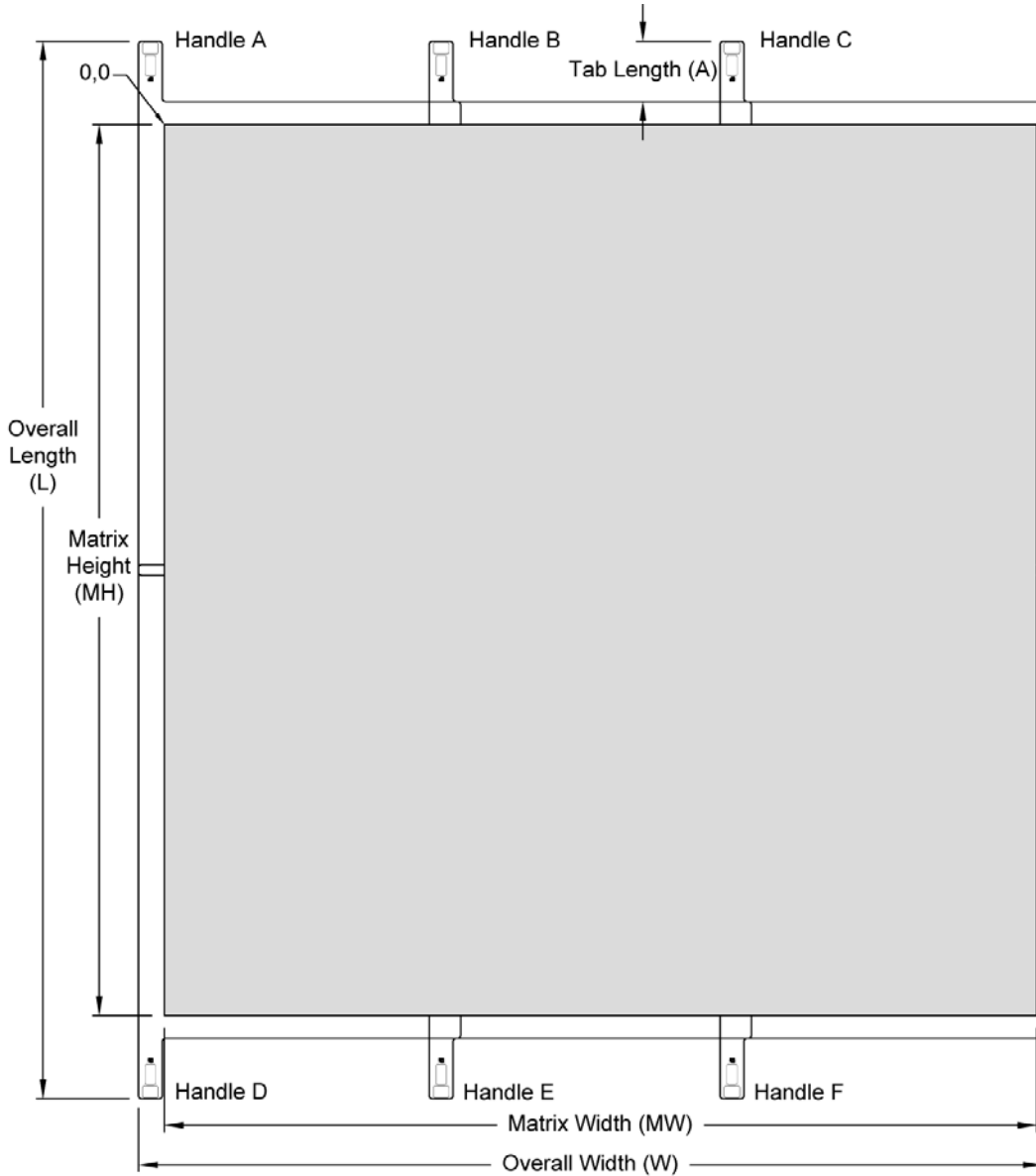

General Dimensions

Sensing Area Dimensions

Model	General Dimensions			Sensing Area Dimensions								Resolution	
	Overall Length L	Overall Width W	Tab Length A	Matrix Width MW	Matrix Height MH	Columns			Rows		Total No. of Sensels		Sensel Density
US	(in.)	(in.)	(in.)	(in.)	(in.)	CW	CS	Qty.	RW	RS		Qty.	
5400NH	82.62	70.19	4.72	68.27	69.61	0.394	0.669	102	0.394	0.669	104	10608	2.2
Metric	(mm)	(mm)	(mm)	(mm)	(mm)	(mm)	(mm)		(mm)	(mm)		(sensel per sq. cm)	
5400NH	2098.5	1782.8	119.9	1734.0	1768.0	10.0	17.0	102	10.0	17.0	104	10608	0.3

SENSOR MODEL: 7101

SENSOR MAP: 7101D

Application Example: Tire footprints

Requirements: 2 sets of Dual Handles or 4 *VersaTek*® Handles and (2) 7101 Sensors

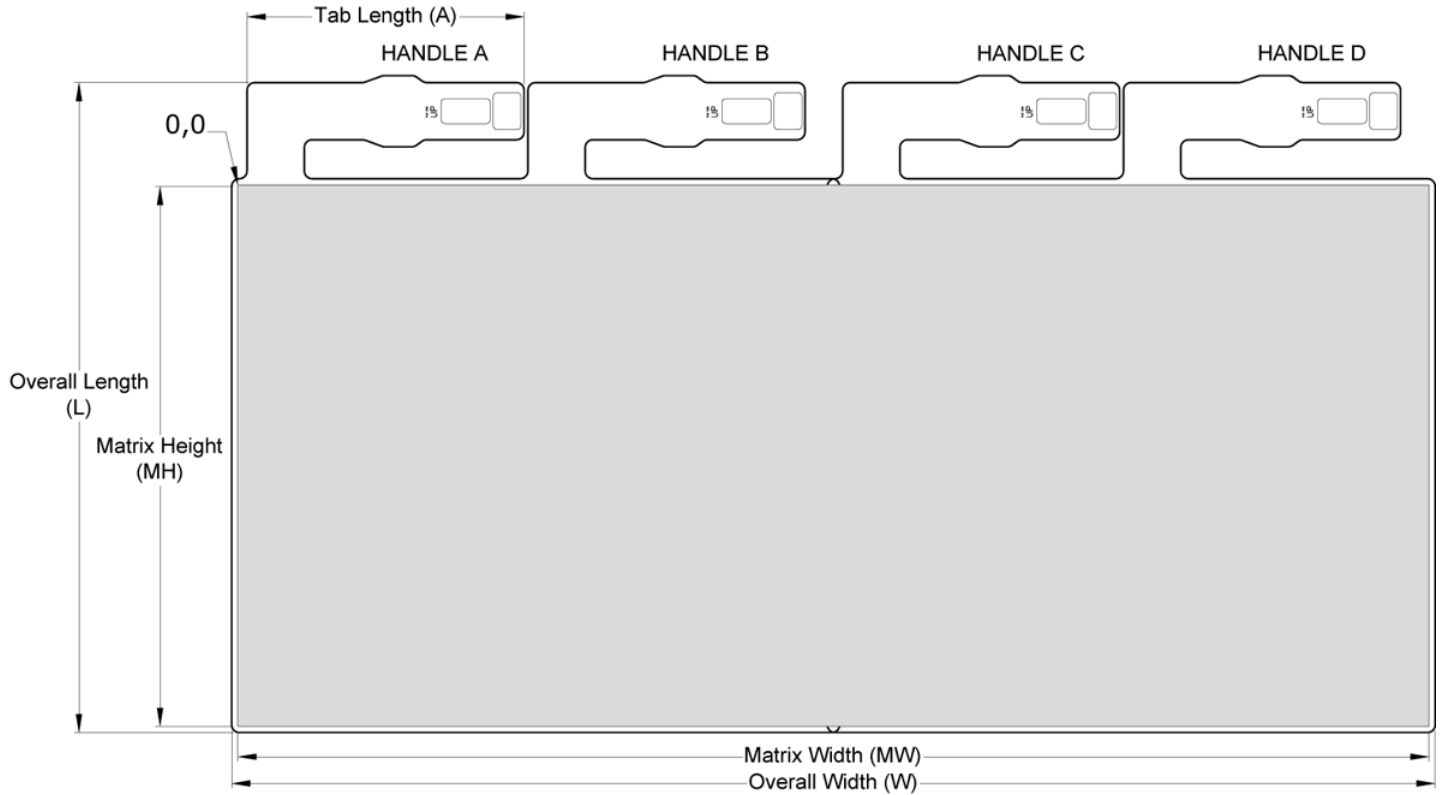

Model	General Dimensions					Sensing Area Dimensions						Total No. of Sensels	Resolution Sensel Density
	Overall Length L	Overall Width W	Tab Length A	Matrix Width MW	Matrix Height MH	Columns			Rows				
						CW	Pitch CS	Qty.	RW	Pitch RS	Qty.		
US	(in.)	(in.)	(in.)	(in.)	(in.)	(in.)	(in.)		(in.)	(in.)		16896	(sensel per sq. in.)
7101D	21.35	39.10	9.00	38.40	17.60	0.125	0.200	192	0.125	0.200	88		25.0
Metric	(mm)	(mm)	(mm)	(mm)	(mm)	(mm)	(mm)		(mm)	(mm)		16896	(sensel per sq. cm)
7101D	542.3	993.1	228.6	975.4	447.0	3.2	5.1	192	3.2	5.1	88		3.9

SENSOR MODEL: 7101

SENSOR MAP: 7101D-2

Application Example: Tire footprints

Requirement:

- 2 sets of Dual Handles or or 4 *VersaTek* Handles and (2) 7101 Sensors

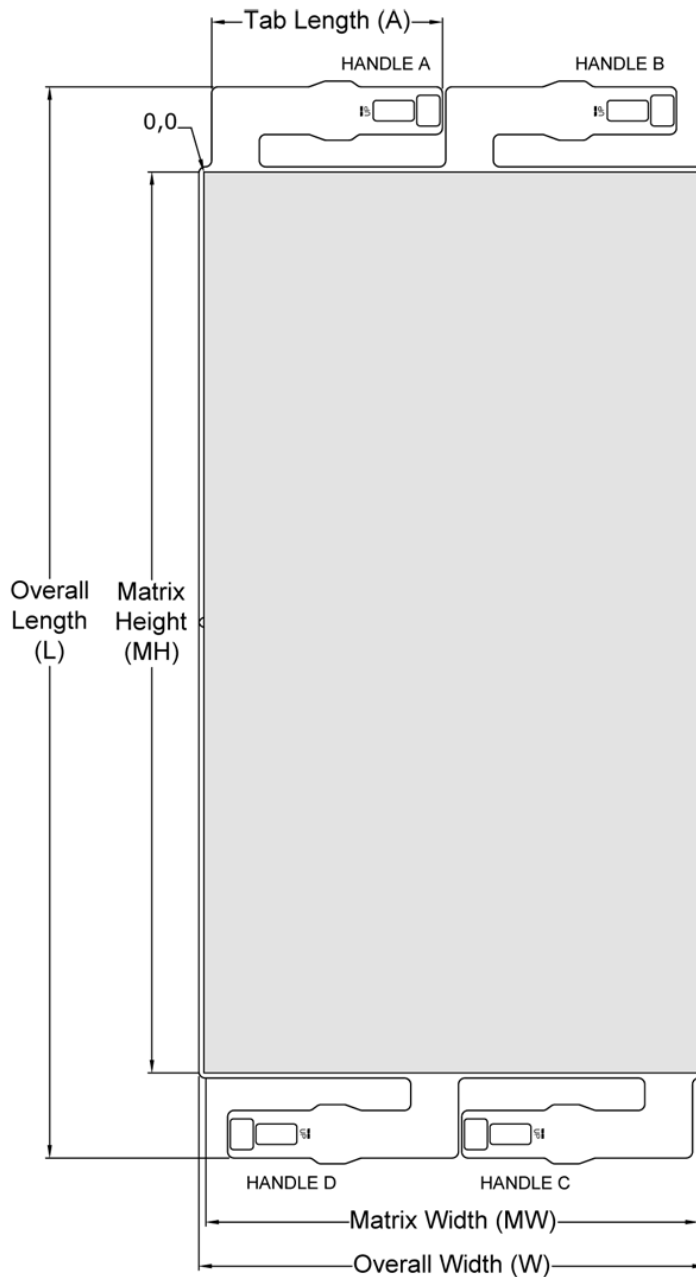

General Dimensions

Sensing Area Dimensions

Model	General Dimensions			Sensing Area Dimensions									Resolution
	Overall Length L	Overall Width W	Tab Length A	Matrix Width MW	Matrix Height MH	Columns			Rows			Total No. of Sensels	
US	(in.)	(in.)	(in.)	(in.)	(in.)	CW	Pitch CS	Qty.	RW	Pitch RS	Qty.		
7101D-2	42.31	19.75	9.00	19.20	35.20	0.125	0.200	96	0.125	0.200	176	16896	25.0
Metric	(mm)	(mm)	(mm)	(mm)	(mm)	(mm)	(mm)		(mm)	(mm)			(sensel per sq. cm)
7101D-2	1074.7	501.7	228.6	487.7	894.1	3.2	5.1	96	3.2	5.1	176	16896	3.9

SENSOR MODEL: 7101

SENSOR MAP: 7101Q

Application Example: Tire footprints

Requirements: 4 sets of Dual Handles or 8 *VersaTek*® Handles and (4) 7101 Sensors

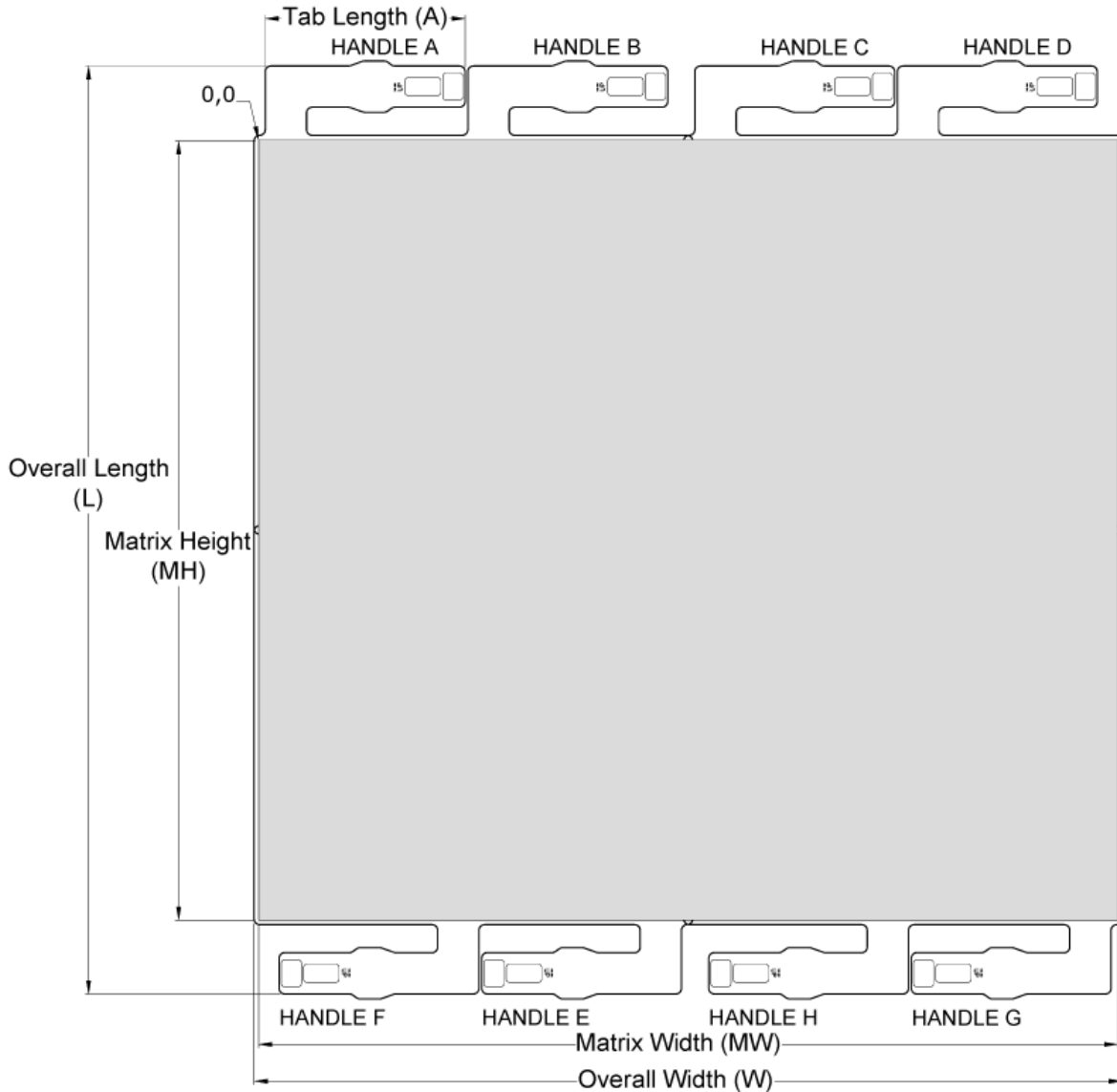

General Dimensions

Sensing Area Dimensions

Model	General Dimensions			Sensing Area Dimensions								Total No. of Sensels	Resolution Sensel Density
	Overall Length L	Overall Width W	Tab Length A	Matrix Width MW	Matrix Height MH	Columns			Rows				
						CW	Pitch CS	Qty.	RW	Pitch RS	Qty.		
US 7101Q	(in.)	(in.)	(in.)	(in.)	(in.)	(in.)	(in.)		(in.)	(in.)		33792	(sensel per sq. in.)
Metric 7101Q	(mm)	(mm)	(mm)	(mm)	(mm)	(mm)	(mm)		(mm)	(mm)			(sensel per sq. cm)
	42.30	39.10	9.00	38.40	35.20	0.125	0.200	192	0.125	0.200	176		25.0
	1074.4	993.1	228.6	975.4	894.1	3.2	5.1	192	3.2	5.1	176	3.9	

SENSOR MODEL: 8000

SENSOR MAP: 8000D

Application Example: Tire footprints

Requirements: 2 sets of Dual Handles or 4 *VersaTek*® Handles and (2) 8000 Sensors

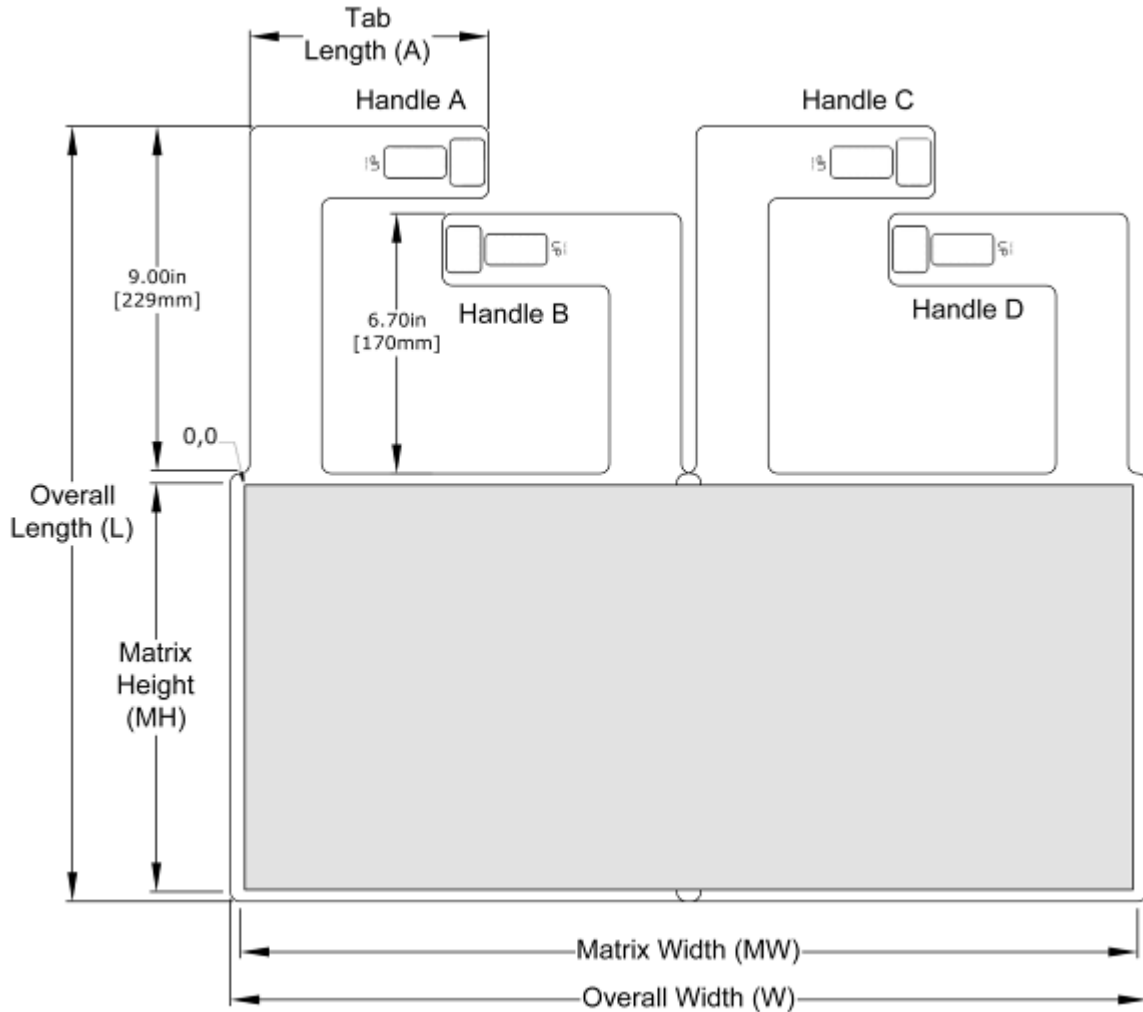

General Dimensions

Sensing Area Dimensions

Model	General Dimensions			Sensing Area Dimensions								Resolution	
	Overall Length L	Overall Width W	Tab Length A	Matrix Width MW	Matrix Height MH	Columns			Rows		Total No. of Sensels		Sensel Density
US	(in.)	(in.)	(in.)	(in.)	(in.)	CW	Pitch CS	Qty.	RW	Pitch RS		Qty.	
8000D	20.00	23.70	8.90	23.04	10.56	0.060	0.120	192	0.060	0.120	88	16896	69.4
Metric	(mm)	(mm)	(mm)	(mm)	(mm)	(mm)	(mm)		(mm)	(mm)		(sensel per sq. cm)	
8000D	508.0	602.0	226.1	585.2	268.2	1.5	3.0	192	1.5	3.0	88	16896	10.8

SENSOR MODEL: 8000

SENSOR MAP: 8000D-2

Application Example: Tire footprints

Requirements:

- 2 sets of Dual Handles or 4 *VersaTek*[®] Handles and (2) 8000 Sensors

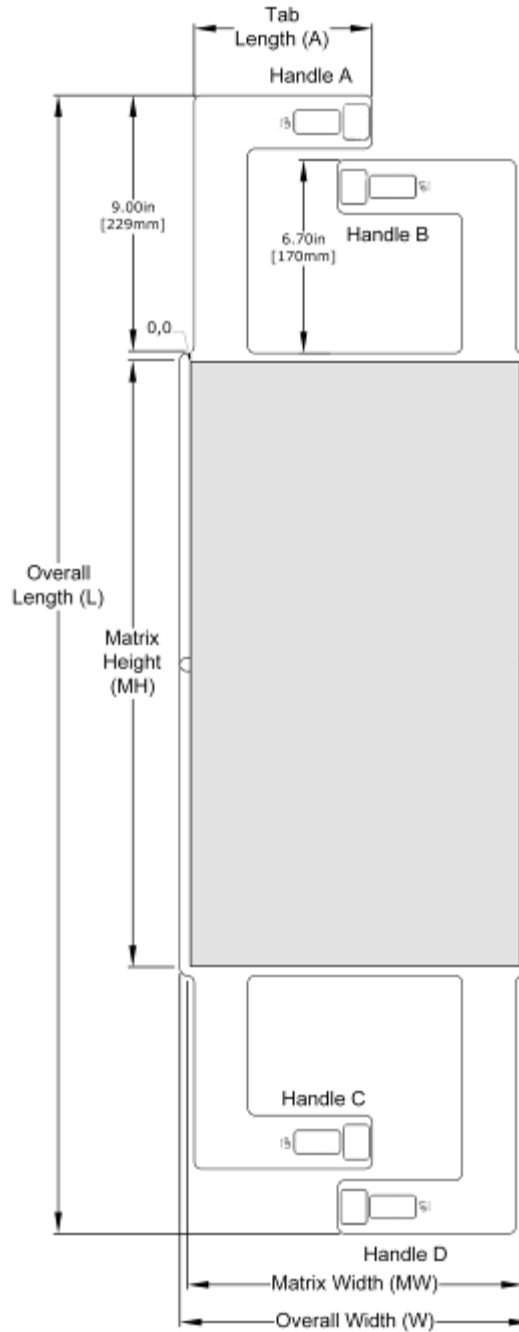

General Dimensions

Sensing Area Dimensions

Model	Overall Length L	Overall Width W	Tab Length A	Matrix Width MW	Matrix Height MH	Columns			Rows			Total No. of Sensels	Resolution Sensel Density
						CW	Pitch CS	Qty.	RW	Pitch RS	Qty.		
US	(in.)	(in.)	(in.)	(in.)	(in.)	(in.)	(in.)		(in.)	(in.)		(sensel per sq. in.)	
8000D-2	39.50	12.15	8.90	11.52	21.12	0.060	0.120	96	0.060	0.120	176	69.4	
Metric	(mm)	(mm)	(mm)	(mm)	(mm)	(mm)	(mm)		(mm)	(mm)		(sensel per sq. cm)	
8000D-2	1003.3	308.6	226.1	292.6	536.4	1.5	3.0	96	1.5	3.0	176	10.8	

SENSOR MODEL: 8000

SENSOR MAP: 8000Q

Application Example: Tire footprints

Requirements:

- 4 sets of Dual Handles or 8 *VersaTek*® Handles and (4) 8000 Sensors

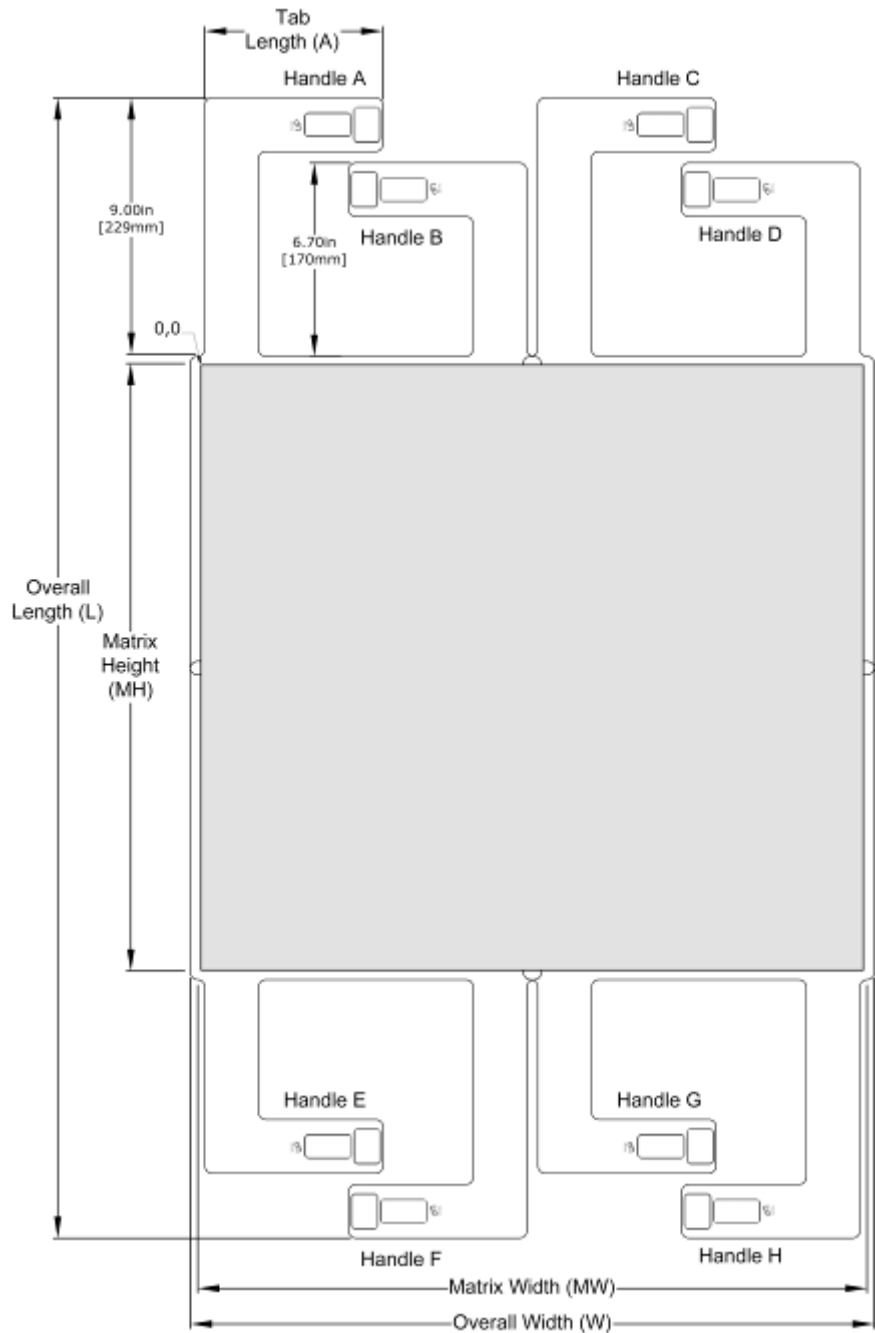

General Dimensions

Sensing Area Dimensions

Model	General Dimensions			Sensing Area Dimensions								Total No. of Senses	Resolution Sensel Density
	Overall Length L	Overall Width W	Tab Length A	Matrix Width MW	Matrix Height MH	Columns			Rows				
	(in.)	(in.)	(in.)	(in.)	(in.)	CW	Pitch CS	Qty.	RW	Pitch RS	Qty.		(sensel per sq. in.)
US 8000Q	39.50	23.70	8.90	23.04	21.12	0.060	0.120	192	0.060	0.120	176	33792	69.4
Metric 8000Q	(mm)	(mm)	(mm)	(mm)	(mm)	(mm)	(mm)	(mm)	(mm)	(mm)	(mm)	33792	(sensel per sq. cm)
	1003.3	602.0	226.1	585.2	536.4	1.5	3.0	192	1.5	3.0	176	33792	10.8

SENSOR MODEL: 8050

Application Example: Tire footprints

Features: External vents

Requirement: 4 Dual Handles

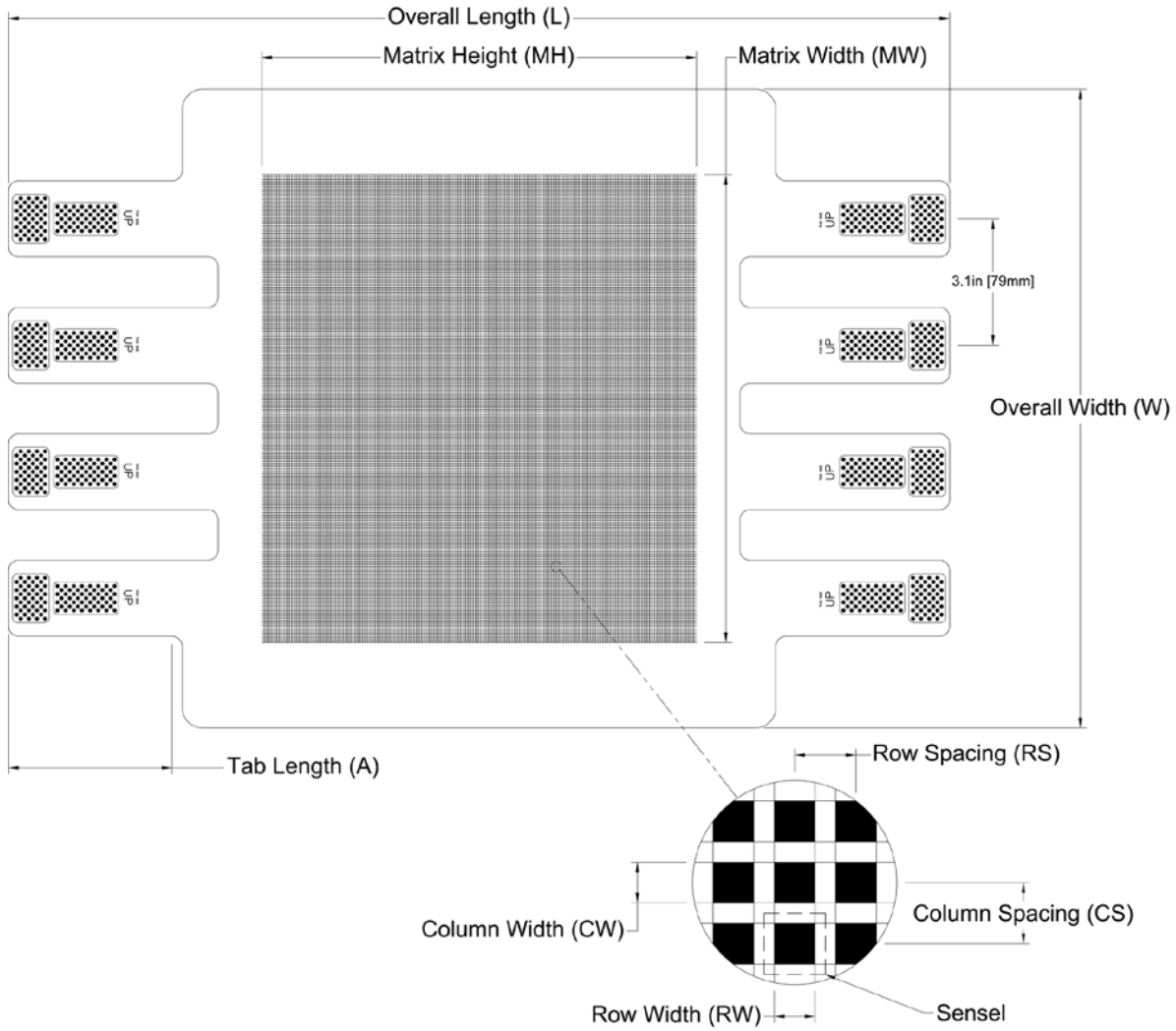

General Dimensions

Sensing Area Dimensions

Model	General Dimensions			Sensing Area Dimensions								Resolution	
	Overall Length L	Overall Width W	Tab Length A	Matrix Width MW	Matrix Height MH	Columns			Rows		Total No. of Sensels	Sensel Density	
	(in.)	(in.)	(in.)	(in.)	(in.)	CW	Pitch CS	Qty.	RW	Pitch RS	Qty.		(sensel per sq. in.)
US 8050	23.04	15.64	4.01	11.52	10.56	0.040	0.060	192	0.040	0.060	176	33792	277.8
Metric 8050	(mm)	(mm)	(mm)	(mm)	(mm)	(mm)	(mm)		(mm)	(mm)			(sensel per sq. cm)
	585.2	397.3	101.7	292.6	268.2	1.0	1.5	192	1.0	1.5	176	33792	43.1

SENSOR MODEL: 8400

Application Example: Tire Footprints

Requirement: 4 VersaTek® Handles

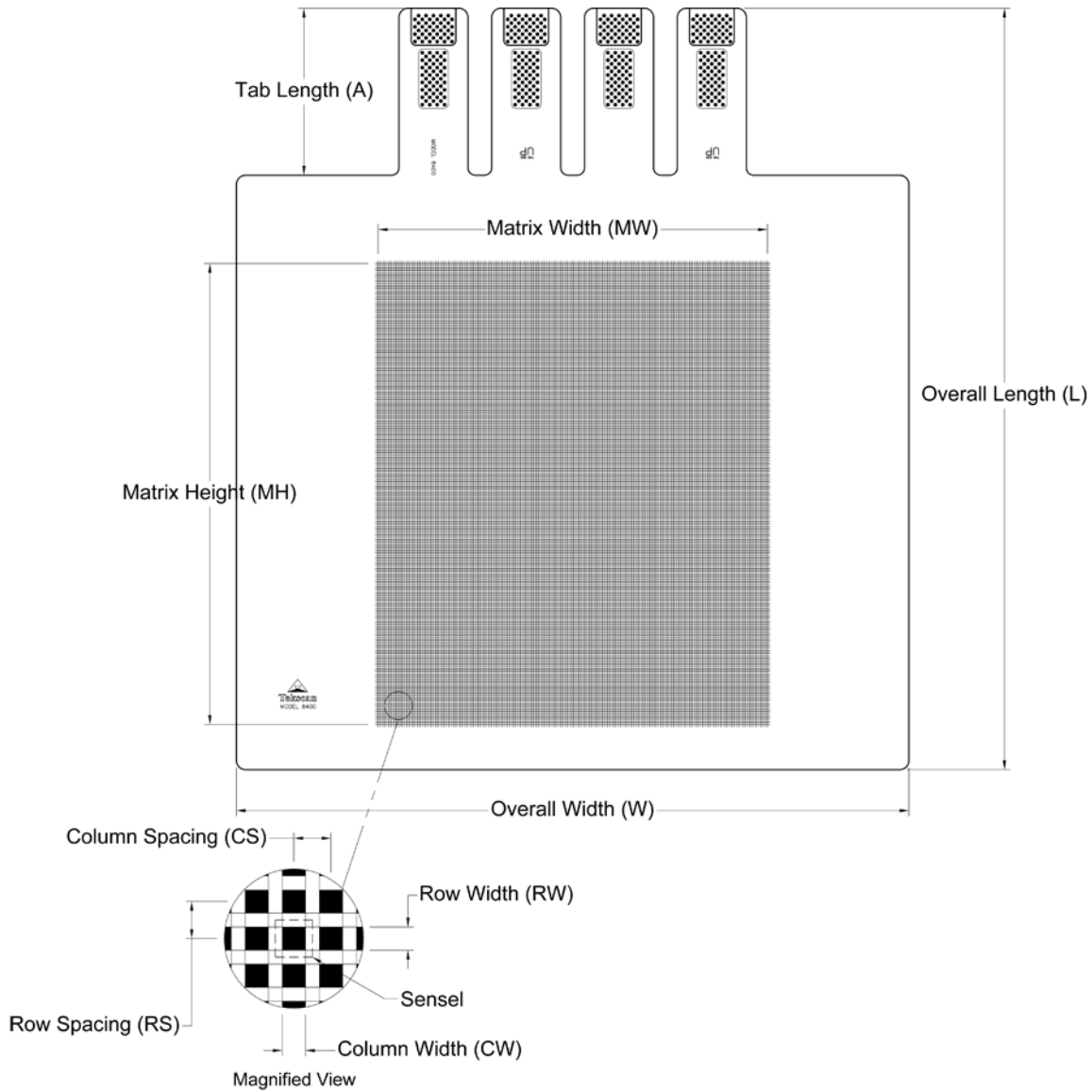

General Dimensions

Sensing Area Dimensions

Model	General Dimensions			Sensing Area Dimensions								Total No. of Sensels	Resolution Sensel Density
	Overall Length L	Overall Width W	Tab Length A	Matrix Width MW	Matrix Height MH	Columns			Rows				
	(in.)	(in.)	(in.)	(in.)	(in.)	CW	Pitch CS	Qty.	RW	Pitch RS	Qty.		(sensel per sq. in.)
US 8400	20.50	18.12	4.50	10.56	12.48	0.040	0.060	176	0.040	0.060	208	36608	277.8
Metric 8400	(mm)	(mm)	(mm)	(mm)	(mm)	(mm)	(mm)		(mm)	(mm)			(sensel per sq. cm)
	520.7	460.2	114.3	268.2	317.0	1.0	1.5	176	1.0	1.5	208	36608	43.1

SENSOR MODEL: 8405

Application Example: Tire Footprints

Requirement: 6 VersaTek® Handles

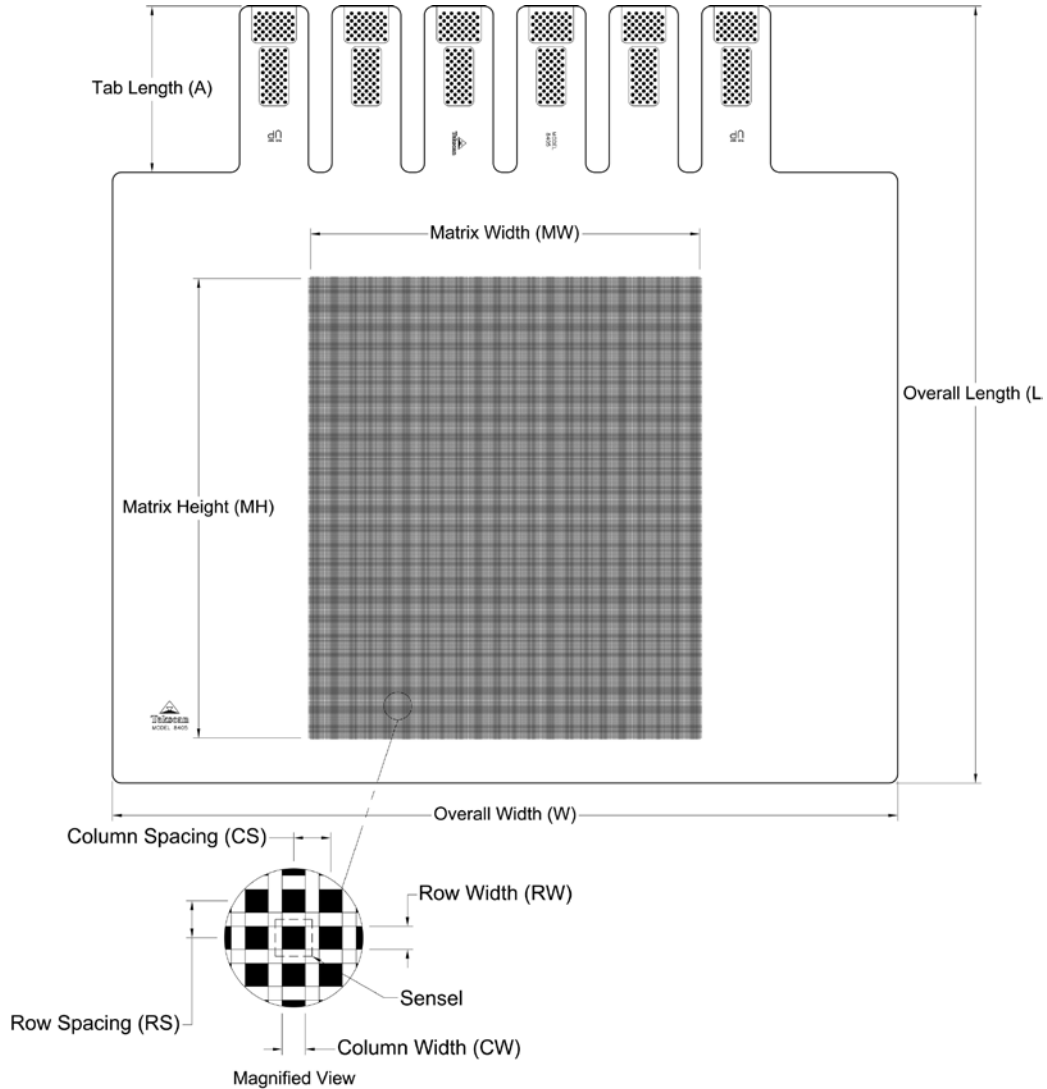

General Dimensions

Sensing Area Dimensions

Model	Overall Length L	Overall Width W	Tab Length A	Matrix Width MW	Matrix Height MH	Columns			Rows			Total No. of Sensels	Resolution Sensel Density
						CW	Pitch CS	Qty.	RW	Pitch RS	Qty.		
US 8405	(in.) 21.00	(in.) 21.20	(in.) 4.50	(in.) 10.56	(in.) 12.48	(in.) 0.015	(in.) 0.040	264	(in.) 0.015	(in.) 0.040	312	82368	(sensel per sq. in.) 625.0
Metric 8405	(mm) 533.4	(mm) 538.5	(mm) 114.3	(mm) 268.2	(mm) 317.0	(mm) 0.4	(mm) 1.0	264	(mm) 0.4	(mm) 1.0	312	82368	(sensel per sq. cm) 96.9

SENSOR MODEL: 8408

Application Example: Tire footprints

Requirement: 8 VersaTek® Handles

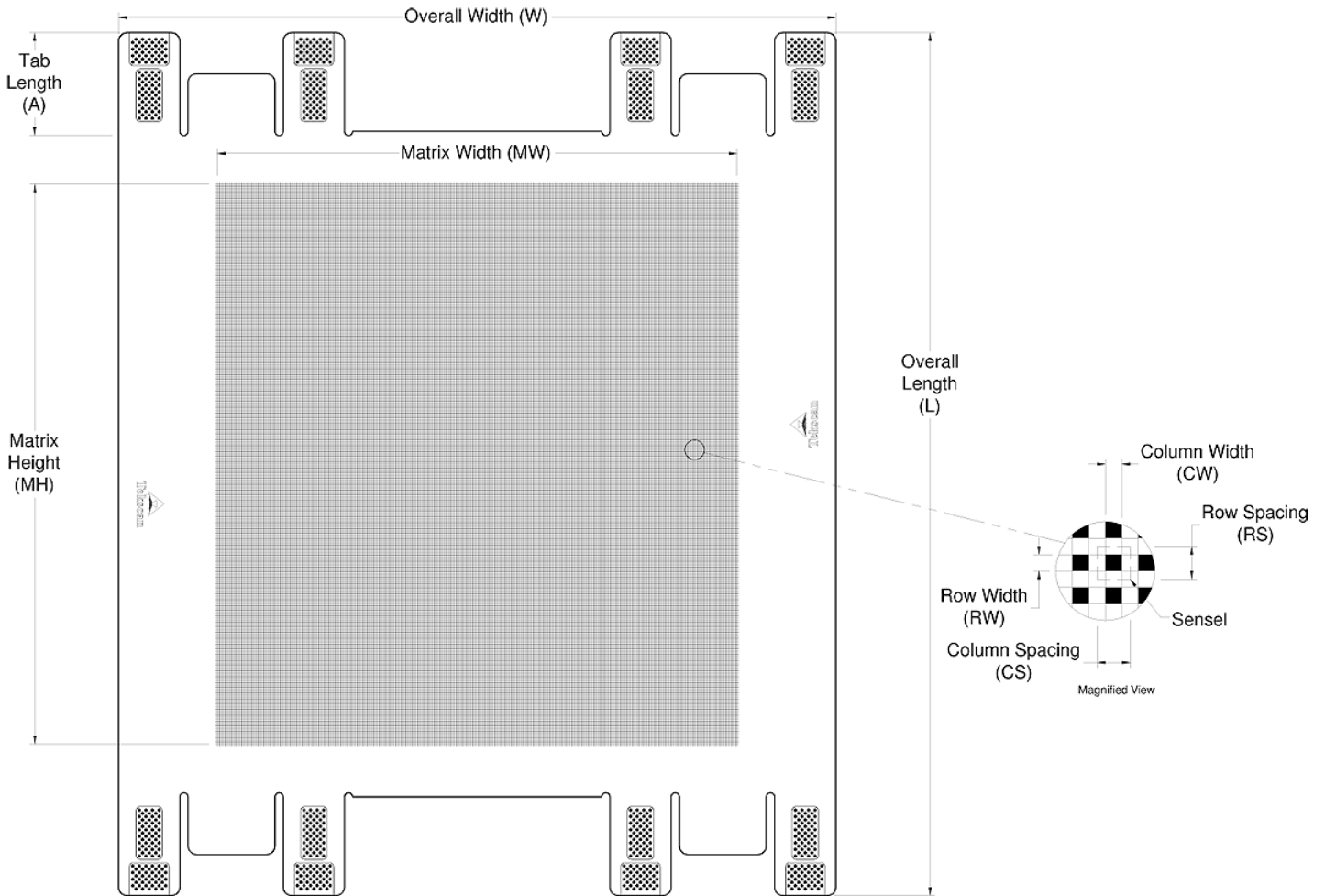

General Dimensions

Sensing Area Dimensions

Model	General Dimensions			Sensing Area Dimensions								Resolution	
	Overall Length L	Overall Width W	Tab Length A	Matrix Width MW	Matrix Height MH	Columns			Rows		Total No. of Sensels	Sensel Density	
	(in.)	(in.)	(in.)	(in.)	(in.)	CW	Pitch CS	Qty.	RW	Pitch RS			Qty.
US 8408	26.21	21.79	3.13	15.84	17.06	0.015	0.045	352	0.015	0.045	379	133408	(sensel per sq. in.) 493.8
Metric 8408	665.7	553.3	79.4	402.3	433.2	0.4	1.1	352	0.4	1.1	379	133408	(sensel per sq. cm) 76.5

Walkway

SENSOR MODEL: 5101

SENSOR MAP: 5101D

Application Examples:

- Small very high resolution walkway
- Small animal gait analysis

Requirement: 2 Handles for use with (2) 5101 Sensors

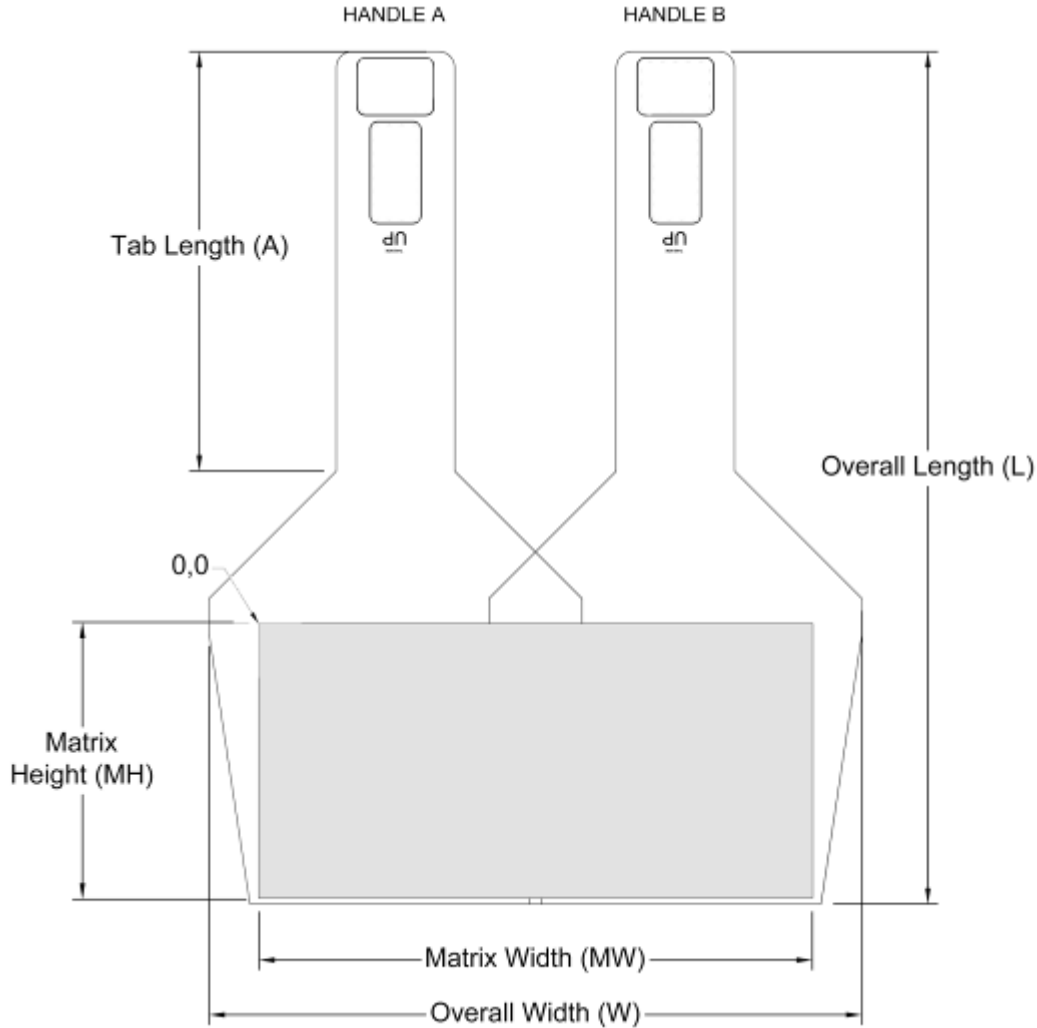

Model	General Dimensions					Sensing Area Dimensions						Total No.of Sensels	Resolution Sensel Density
	Overall Length L	Overall Width W	Tab Length A	Matrix Width MW	Matrix Height MH	Columns			Rows				
						CW	Pitch CS	Qty.	RW	Pitch RS	Qty.		
US	(in.)	(in.)	(in.)	(in.)	(in.)	(in.)	(in.)		(in.)	(in.)			(sensel per sq. in.)
5101D	13.39	10.20	6.59	8.80	4.40	0.050	0.100	88	0.050	0.100	44	3872	100.0
Metric	(mm)	(mm)	(mm)	(mm)	(mm)	(mm)	(mm)		(mm)	(mm)			(sensel per sq. cm)
5101D	340.1	259.1	167.4	223.5	111.8	1.3	2.5	88	1.3	2.5	44	3872	15.5

SENSOR MODEL: 5101

SENSOR MAP: 5101TL

Application Examples:

- Small very high resolution walkway
- Small animal gait analysis

Requirements: 3 Handles for use with (3) 5101 Sensors

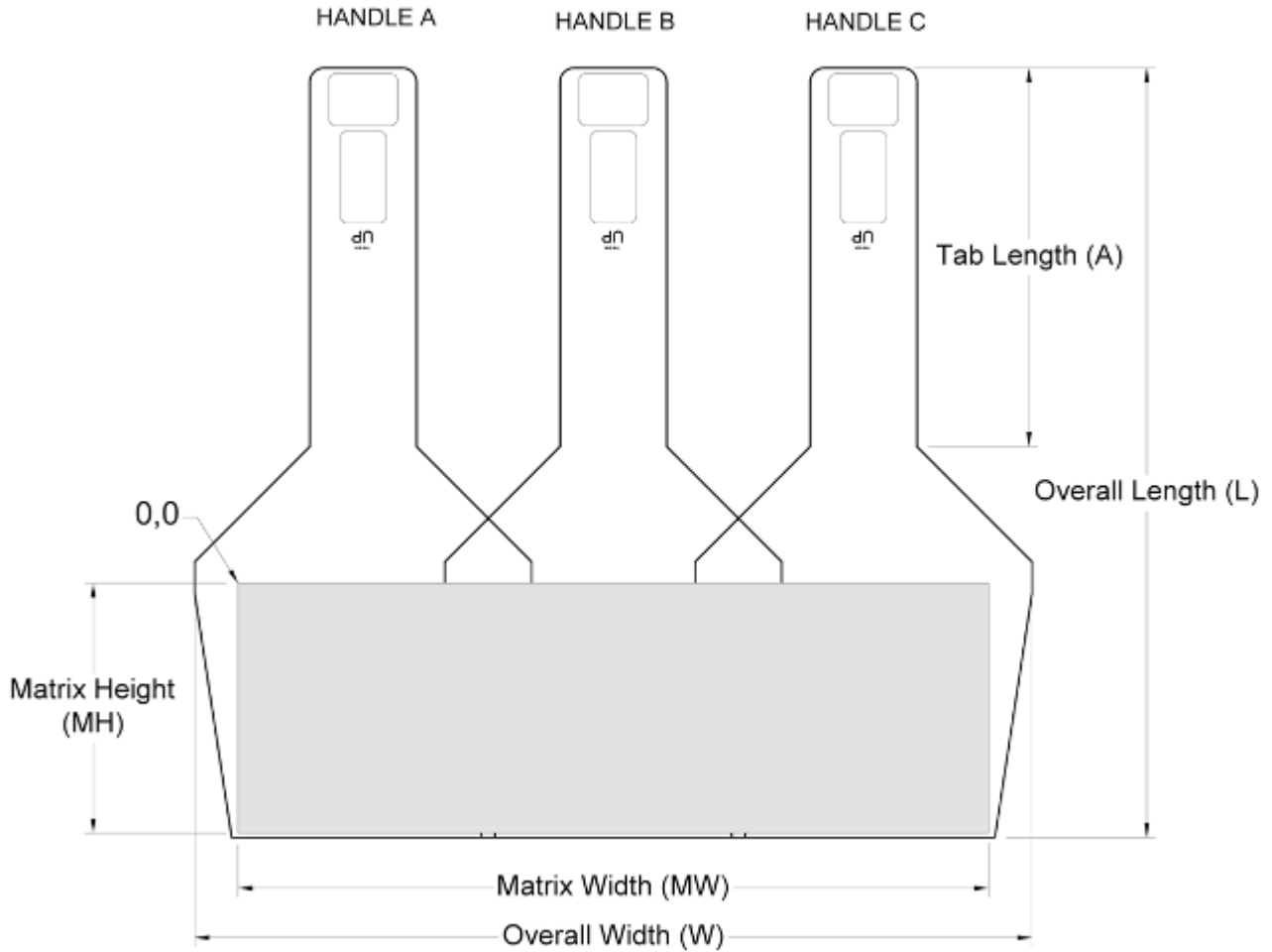

General Dimensions

Sensing Area Dimensions

Model	General Dimensions			Sensing Area Dimensions								Total No. of Sensels	Resolution Sensel Density	
	Overall Length	Overall Width	Tab Length	Matrix Width	Matrix Height	Columns			Rows					
	L	W	A	MW	MH	CW	CS	Qty.	RW	RS	Qty.			
US	(in.)	(in.)	(in.)	(in.)	(in.)	(in.)	(in.)		(in.)	(in.)				(sensel per sq. in.)
5101TL	13.39	14.57	6.59	13.20	4.40	0.050	0.100	132	0.050	0.100	44	5808	100.0	
Metric	(mm)	(mm)	(mm)	(mm)	(mm)	(mm)	(mm)		(mm)	(mm)				(sensel per sq. cm)
5101TL	340.1	370.1	167.4	335.3	111.8	1.3	2.5	132	1.3	2.5	44	5808	15.5	

SENSOR MODEL: 5101

SENSOR MAP: 5101QL

Application Examples:

- Small very high resolution walkway
- Small animal gait analysis

Requirements: 4 Handles for use with (4) 5101 Sensors

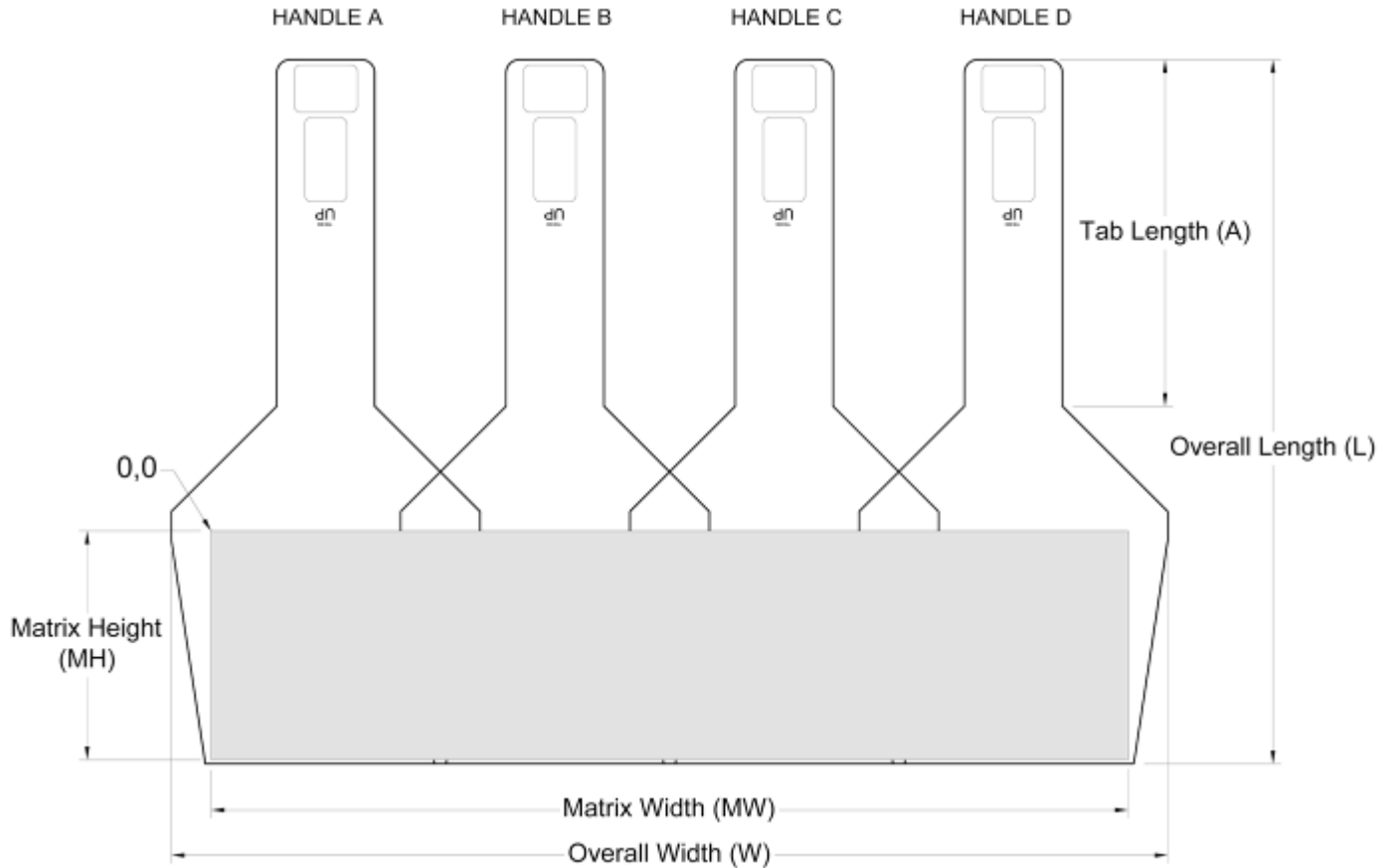

Model	General Dimensions					Sensing Area Dimensions						Resolution Sensel Density	
	Overall Length L	Overall Width W	Tab Length A	Matrix Width MW	Matrix Height MH	Columns			Rows				Total No. of Sensels
						CW	CS	Qty.	RW	RS	Qty.		
US 5101QL	(in.) 13.39	(in.) 18.93	(in.) 6.59	(in.) 17.60	(in.) 4.40	(in.) 0.050	(in.) 0.100	176	(in.) 0.050	(in.) 0.100	44	7744	(sensel per sq. in.) 100.0
Metric 5101QL	(mm) 340.1	(mm) 480.8	(mm) 167.4	(mm) 447.0	(mm) 111.8	(mm) 1.3	(mm) 2.5	176	(mm) 1.3	(mm) 2.5	44	7744	(sensel per sq. cm) 15.5

SENSOR MODEL: 7101

SENSOR MAP: 7101D

Application Example: High resolution walkway

Requirements:

- 2 sets of Dual Handles or 4 *VersaTek*® Handles for use with (2) 7101 Sensors

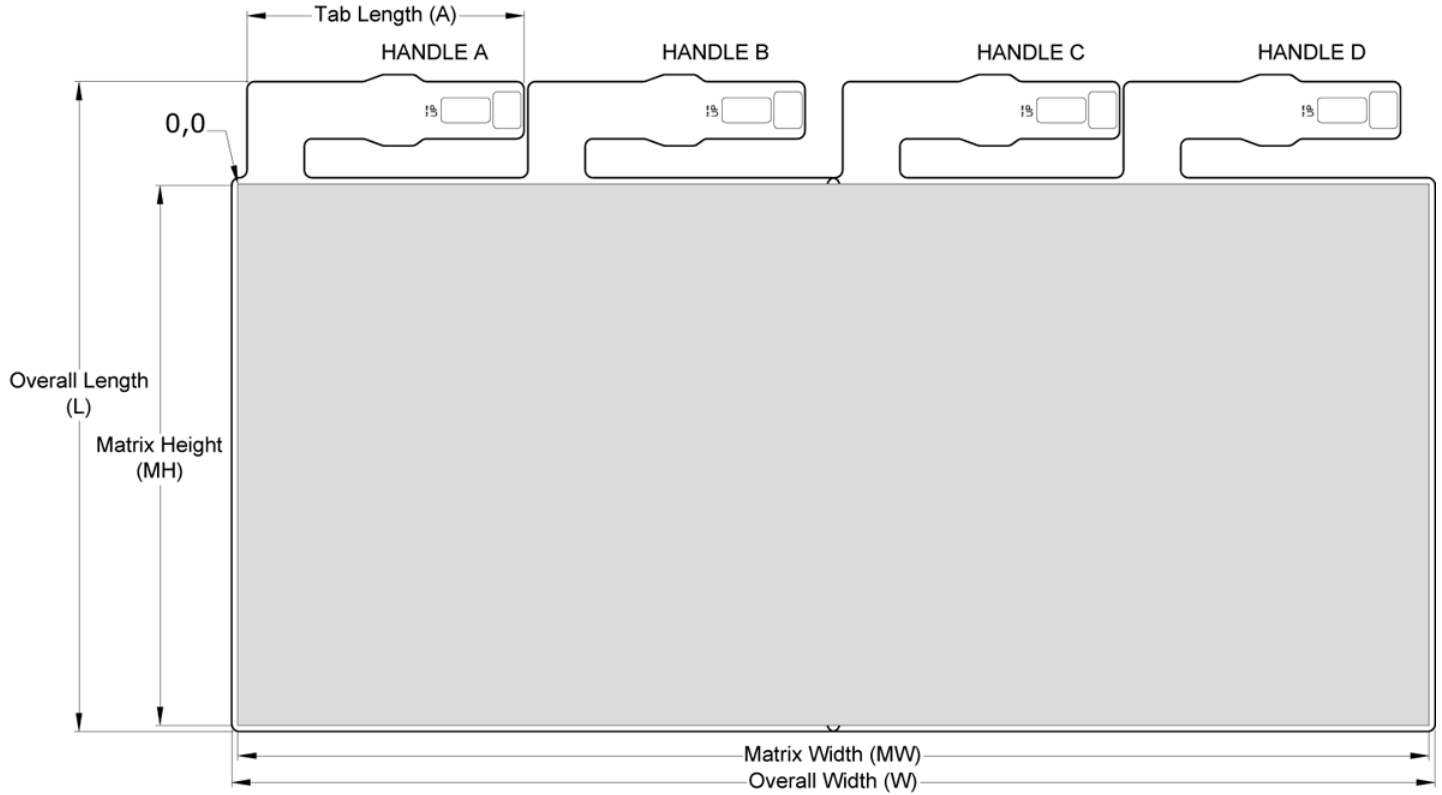

General Dimensions

Sensing Area Dimensions

Model	General Dimensions			Sensing Area Dimensions								Total No. of Sensels	Resolution Sensel Density
	Overall Length L	Overall Width W	Tab Length A	Matrix Width MW	Matrix Height MH	Columns			Rows				
	(in.)	(in.)	(in.)	(in.)	(in.)	CW	Pitch CS	Qty.	RW	Pitch RS	Qty.		(sensel per sq. in.)
US 7101D	21.35	39.10	9.00	38.40	17.60	0.125	0.200	192	0.125	0.200	88	16896	25.0
Metric 7101D	(mm) 542.3	(mm) 993.1	(mm) 228.6	(mm) 975.4	(mm) 447.0	(mm) 3.2	(mm) 5.1	192	(mm) 3.2	(mm) 5.1	88	16896	(sensel per sq. cm) 3.9

SENSOR MODEL: 7101

SENSOR MAP: 7101D-2

Application Example: High resolution walkway

Requirement:

- 2 sets of DUAL Handles or 4 VersaTek® Handles and (2) 7101 Sensors

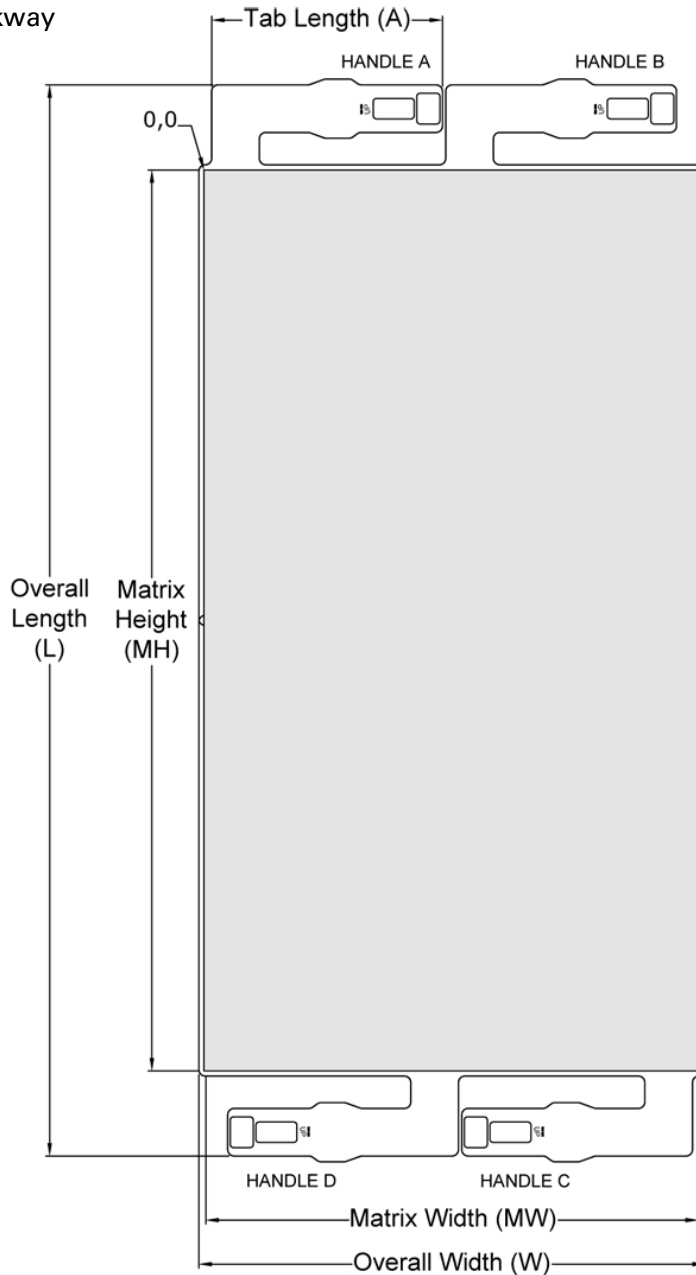

General Dimensions

Sensing Area Dimensions

Model	General Dimensions			Sensing Area Dimensions								Total No. of Sensels	Resolution Sensel Density
	Overall Length L	Overall Width W	Tab Length A	Matrix Width MW	Matrix Height MH	Columns			Rows				
	(in.)	(in.)	(in.)	(in.)	(in.)	CW	Pitch CS	Qty.	RW	Pitch RS	Qty.		(sensel per sq. in.)
US 7101D-2	42.31	19.75	9.00	19.20	35.20	0.125	0.200	96	0.125	0.200	176	16896	25.0
Metric 7101D-2	1074.7	501.7	228.6	487.7	894.1	3.2	5.1	96	3.2	5.1	176	16896	3.9

SENSOR MODEL: 7101

SENSOR MAP: 7101Q

Application Example: High resolution walkway

Requirement: 4 sets of Dual Handles or 8 *VersaTek* and (4) 7101 Sensors

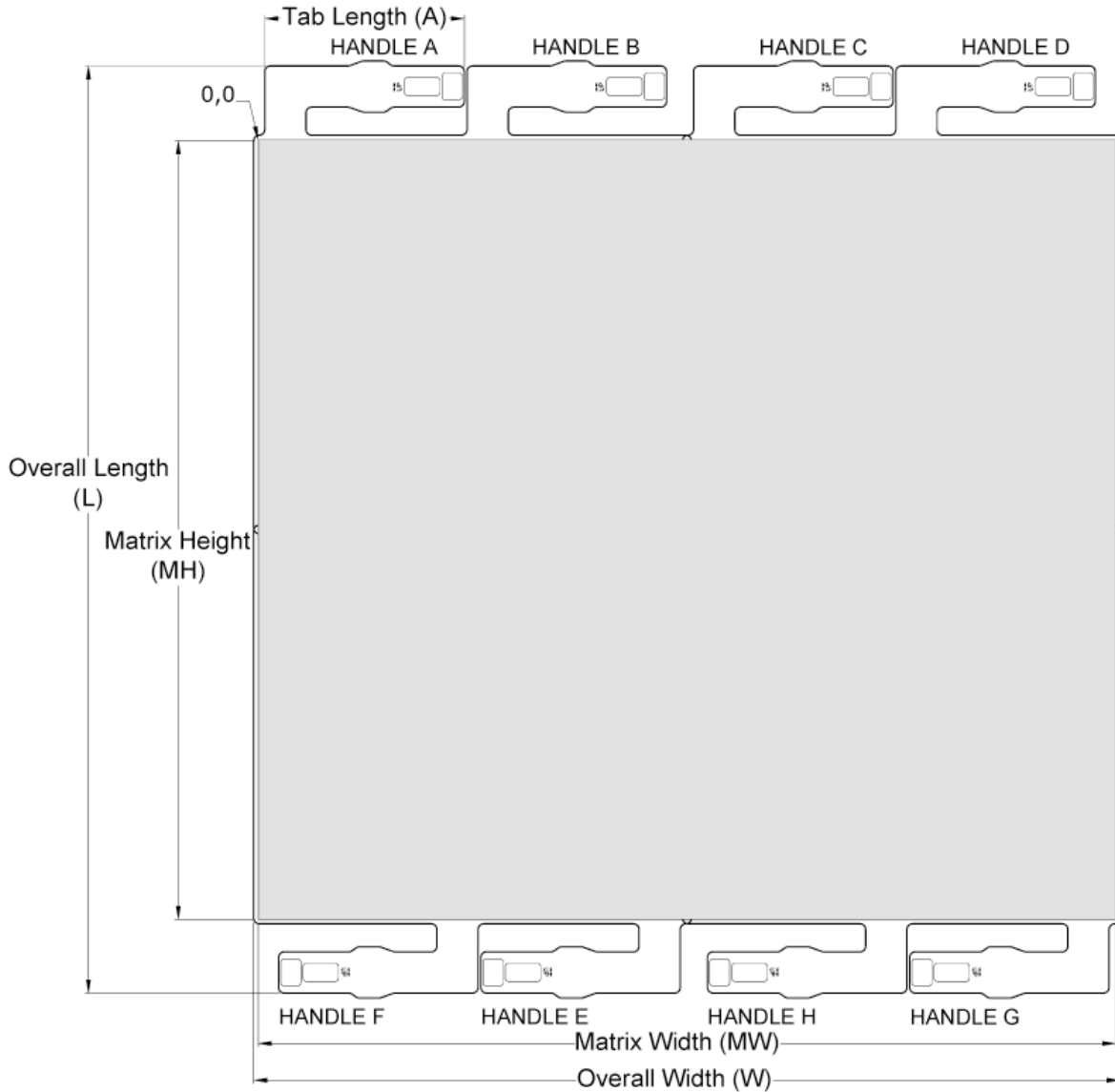

General Dimensions

Sensing Area Dimensions

Model	General Dimensions			Sensing Area Dimensions								Total No. of Sensels	Resolution Sensel Density
	Overall Length L	Overall Width W	Tab Length A	Matrix Width MW	Matrix Height MH	Columns			Rows				
US	(in.)	(in.)	(in.)	(in.)	(in.)	CW	Pitch CS	Qty.	RW	Pitch RS	Qty.		(sensel per sq. in.)
7101Q	42.30	39.10	9.00	38.40	35.20	0.125	0.200	192	0.125	0.200	176	33792	25.0
Metric	(mm)	(mm)	(mm)	(mm)	(mm)	(mm)	(mm)		(mm)	(mm)			(sensel per sq. cm)
7101Q	1074.4	993.1	228.6	975.4	894.1	3.2	5.1	192	3.2	5.1	176	33792	3.9