

GB - Quick Start Guide
SE - Snabbstarts-guide
FI - Pikaopas

C.A 6131 C.A 6133



Installation testers
Installationstestare
Asennustesterit

Measure up



Inserting the batteries or accumulators / Sätta i batterier eller ackumulatore / Paristojen tai akkujen asettaminen

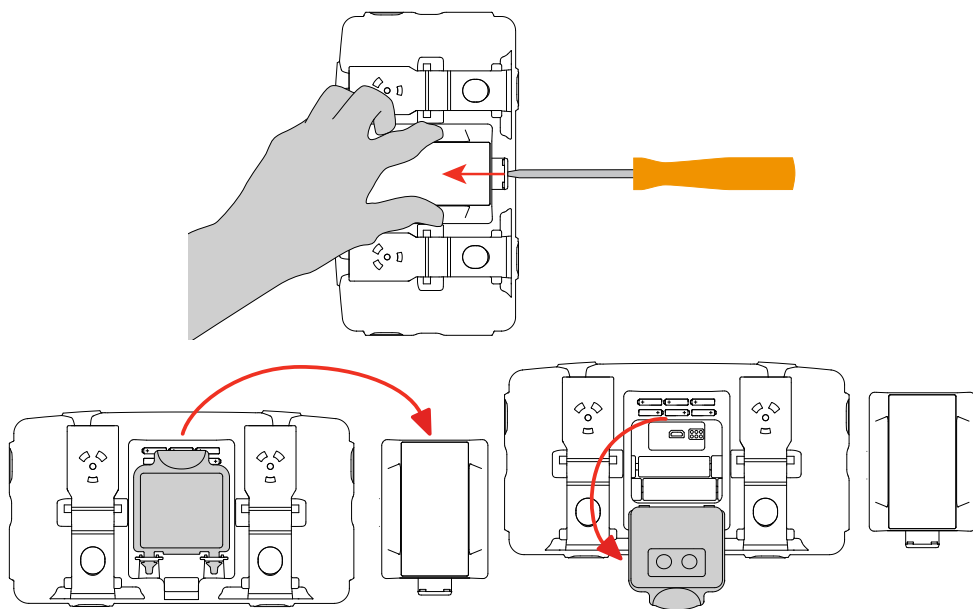

C.A 6133 - Charging the battery / Ladda batterierna / Akun lataaminen

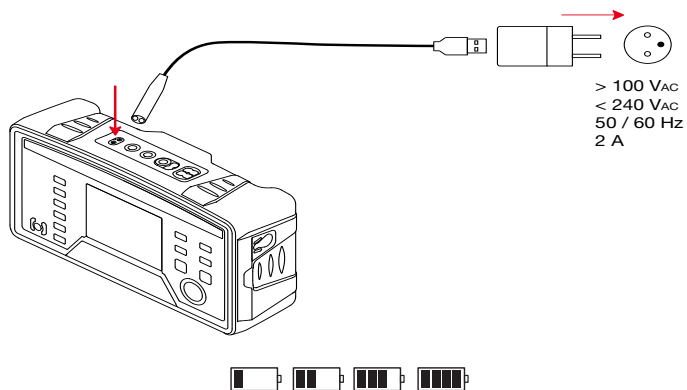

Voltage measurement / Spänningsmätning / Jännitteen mittaus

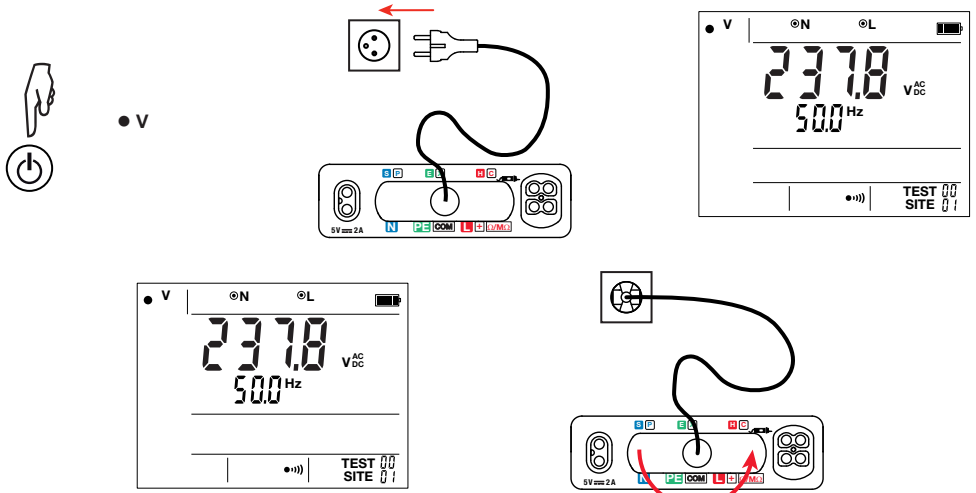

Compensation of the leads / Kompensation av mätledarna / Mittausjohtojen kompensointi

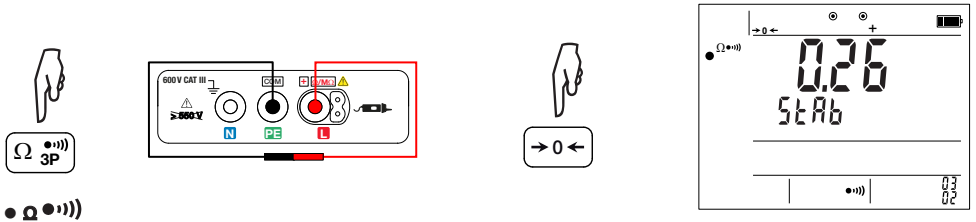

Continuity measurement / Kontinuitetsmätning / Jatkuvuuden mittaus

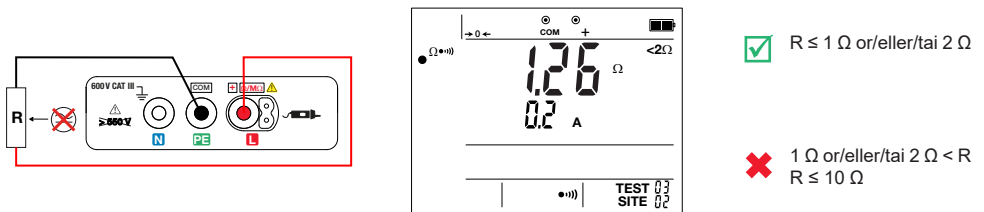

Resistance measurement / Resistansmätning / Vastuksen mittaus

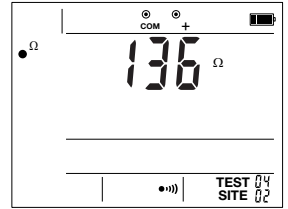
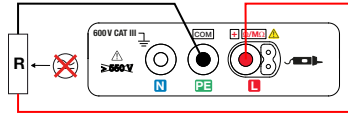
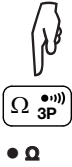

Insulation resistance measurement / Isolationsresistansmätning / Eristysvastuksen mittaus

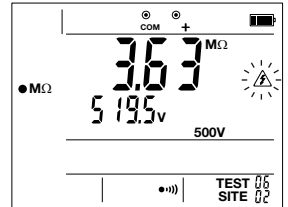
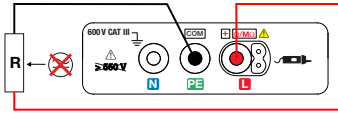

✓ R > threshold / gränsvärde / raja-arvo

✗ R ≤ threshold / gränsvärde / raja-arvo

C.A 6133 - 3P earth resistance measurement / 3P jordresistansmätning / 3P maadoitusvastuksen mittaus

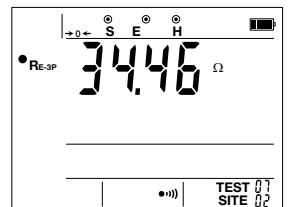
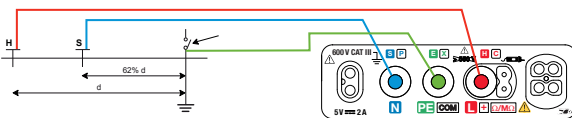
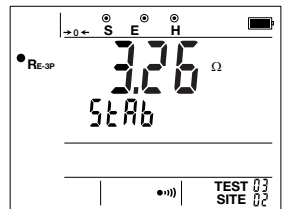
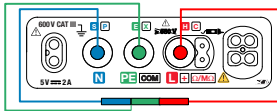
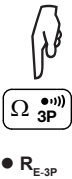

No-trip loop impedance measurement / Loopimpedansmätning utan utlösning / Laukeamaton silmukkaimpedanssin mittaus

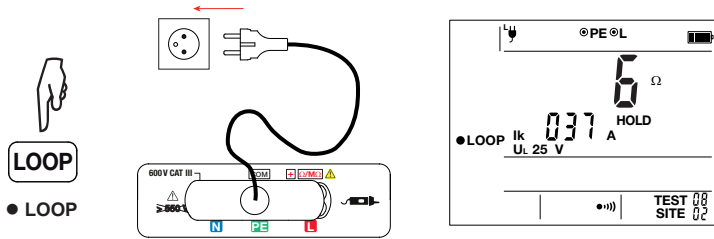

Trip mode loop impedance measurement / Loopimpedansmätning med utlösning / Silmukkaimpedanssin mittaus laukaisutilassa

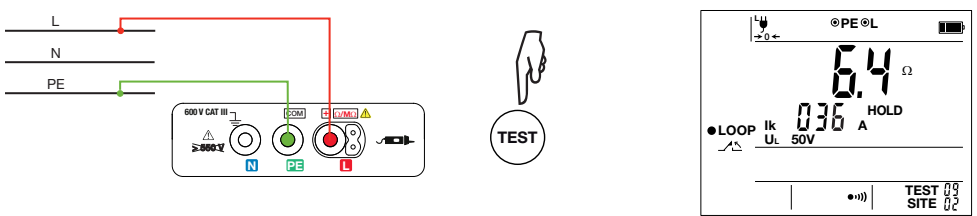
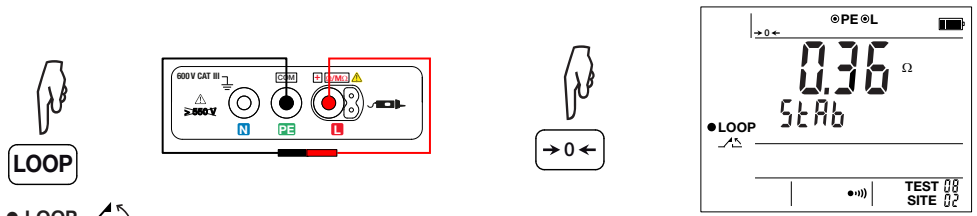

No-trip test of residual current device / RCD-test utan utlösning / Laukeamaton vikavirtasuojakytkimen testaus

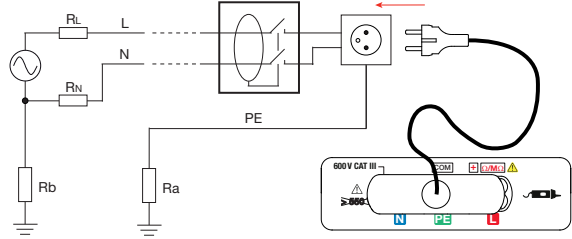

RCD
 ● RCD

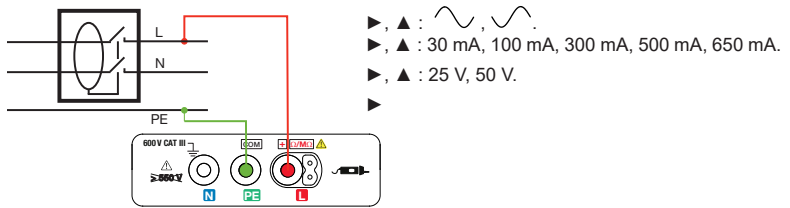

or / eller / tai

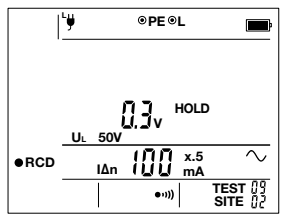

TEST



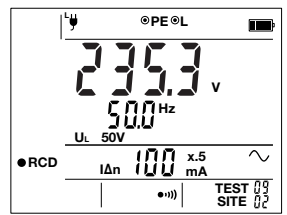

TEST



Test of residual current device in ramp mode / RCD-test i rampläge / Vikavirtasuojakytkimen testaus ramppitilassa



RCD
 ● RCD 

- ▶, ▲ : A, AC.
- ▶, ▲ : 
- ▶, ▲ : 25 V, 50 V.

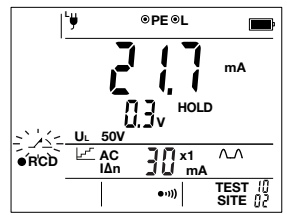

TEST



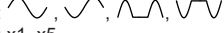

Test of residual current device in pulse mode / RCD-test i pulsläge / Vikavirtasuojakytkimen testaus pulssitilassa



- ▶, ▲ : A, AC.
- ▶, ▲ : 
- ▶, ▲ : x1, x5.
- ▶, ▲ : 30 mA, 100 mA, 300 mA, 500 mA, 650 mA.
- ▶, ▲ : 25 V, 50 V.





● RCD 

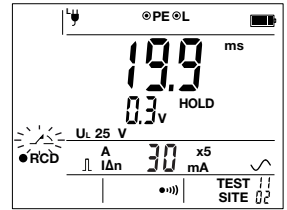

C.A 6131 - Current measurement / Strömmätning / Virran mittaus

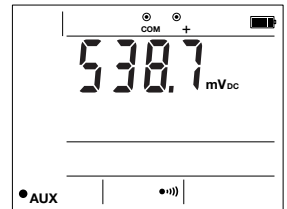
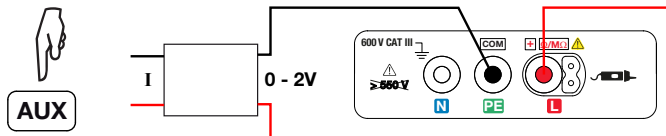

C.A 6133 - Current measurement / Strömmätning / Virran mittaus

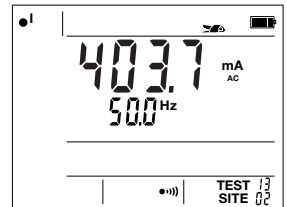
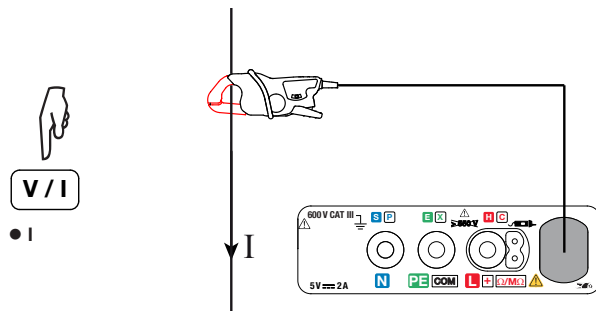

Direction of phase rotation / Fasföljdsindikering / Vaiheen kiertosuunta

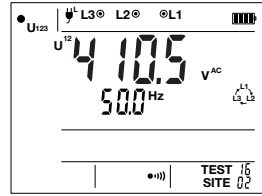
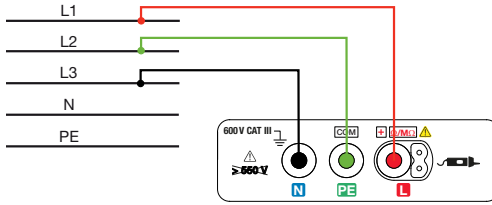
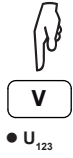

FRANCE
Chauvin Arnoux Group
190, rue Championnet
75876 PARIS Cedex 18
Tél : +33 1 44 85 44 85
Fax : +33 1 46 27 73 89
info@chauvin-arnoux.com
www.chauvin-arnoux.com

INTERNATIONAL
Chauvin Arnoux Group
Tél : +33 1 44 85 44 38
Fax : +33 1 46 27 95 69

Our international contacts
www.chauvin-arnoux.com/contacts

