

Visual Material Solutions

Measuring pressure, heat or UV light easily with each film.

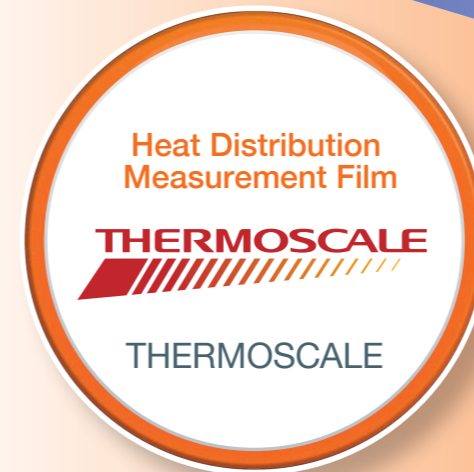

Pressure Measurement Film

PRESCALE

The only film that could measure the pressure visually by the color density



"Prescale" is a film that could easily measure the distribution and the amount of pressure. It was created by using the Fujifilm's advanced technology of coating a thin film and it visualizes the pressure distribution of the whole surface by changing its color to red according to the applied pressure. There are nine types of rolls so as to cover the wide range of pressure.

There is also a product "Presheet" in which the Prescale is cut into a sheet in advance.

How to Use

Just cut and insert the film to the surface you need to measure

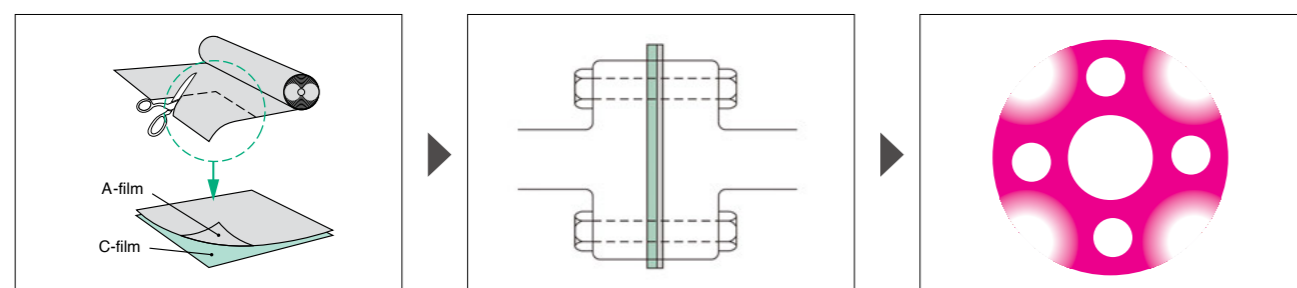

(1) Cut the Prescale Film into the required shape. With the Two-sheet film, make sure the coated sides on A-Film and C-Film face each other.

(2) Insert cut Prescale Film into area to be measured and apply pressure.

(3) Remove film and observe pressure distribution.

Type of Prescale

There are 9 types of Prescale and 6 types of Presheet according to the pressure range. Please select the appropriate prescale.

Product (Code)	Pressure range [MPa] 1MPa≒10.2kgf/cm ²		Roll Type Product size W(mm)×L(m)	Sheet Type Product size W(mm)×L(mm)	Type								
	0.006 0.87~7.3	0.05 7.25				0.2 29	0.5 73	0.6 87	2.5 363	10 1,450	50 7,250	130 18,850	300 43,500
	Pressure range [psi] 1psi≒6895pa												
Super high pressure (HHS)	[Color bar]										270 × 10	270 × 200 (5 sheets)	Mono-sheet
High pressure (HS)	[Color bar]										270 × 10	270 × 200 (5 sheets)	Mono-sheet
Medium pressure (MS)	[Color bar]										270 × 10	270 × 200 (5 sheets)	Mono-sheet
Medium pressure (MW)	[Color bar]										270 × 10	—	Two-sheet
Low pressure (LW)	[Color bar]										270 × 10	270 × 200 (5 sheets)	Two-sheet
Super low pressure (LLW)	[Color bar]										270 × 6	270 × 200 (5 sheets)	Two-sheet
Ultra super low pressure (LLLW)	[Color bar]										270 × 5	270 × 200 (5 sheets)	Two-sheet
Extreme low pressure (4LW)	[Color bar]										320 × 3	—	Two-sheet
Ultra extreme low(5LW)	[Color bar]										320 × 2	—	Two-sheet

Notes: W in the product codes indicates two-sheet type, S indicates mono-sheet type

How It Works

Two-sheet type (5LW~MW)

Composed of two kinds of films: A-film and C-film

- **A-film:** Base material (PET base) coated with a color-forming material (microcapsules)
- **C-film:** Base material (PET base) coated with a color-developing material

The coated sides of each film (color-forming and color-developing) must face each other. These are the sides with the matt finish. When pressure is applied, the microcapsules are broken and the color-forming material transfers to the color-developing material and reacts, thereby generating a red color.

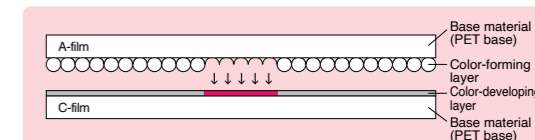

Mono-sheet type (MS~HHS)

Measurement is possible with a single sheet of film.

- **A color-developing material and color-forming material (microcapsules) are coated, one above the other, on a single base material (PET base).**

When pressure is applied, the microcapsules are broken and the color-developing material absorbs the color-forming material and reacts, thereby generating a red color.

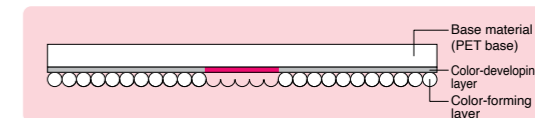

Prescale Color Chart (LW)

Can get the value of pressure by referring to the color chart.

Continuous pressure

Measurement pressure range: Low pressure (2.5~10MPa)
Pressurized condition: Time to reach the pressure 2min.

Time of retention at the pressure 2 min.

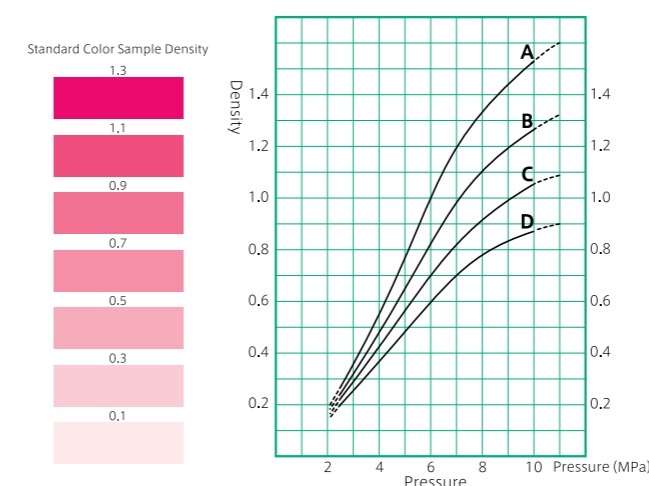

As the pressure indicated by the broken line may exceed the permissible error range, please use the data for reference purpose only.

Momentary pressure

Measurement pressure range: Low pressure (2.5~10MPa)
Pressurized condition: Time to reach the pressure 5 sec.

Time of retention at the pressure 5 sec.

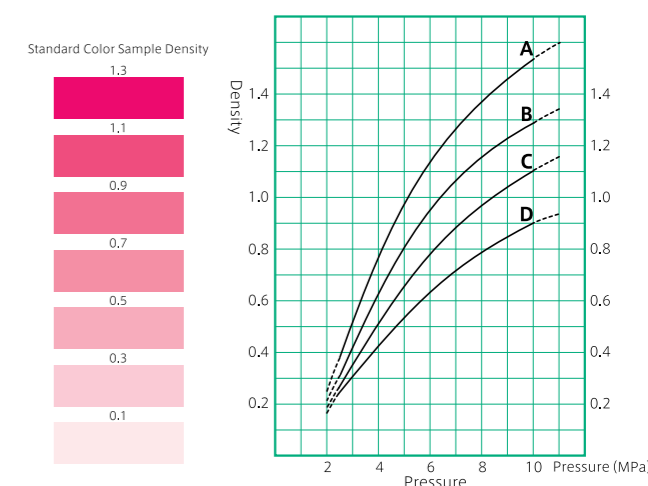

As the pressure indicated by the broken line may exceed the permissible error range, please use the data for reference purpose only.











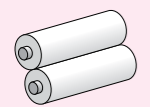
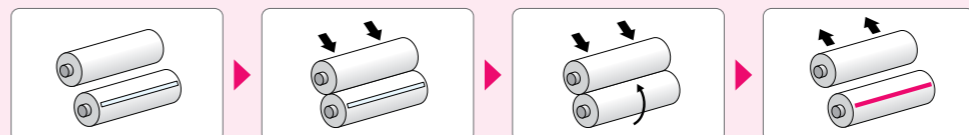

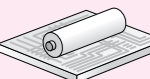
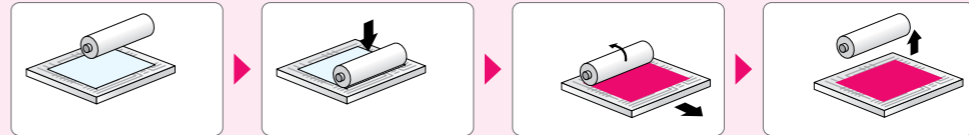
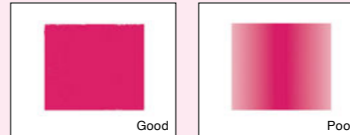
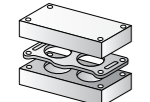
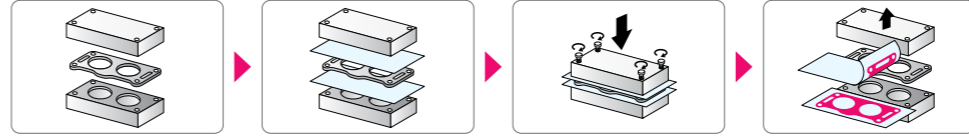
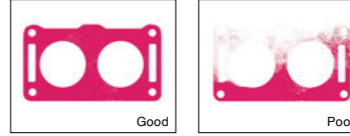
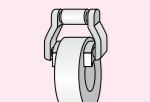
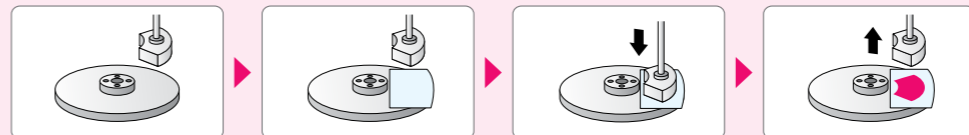
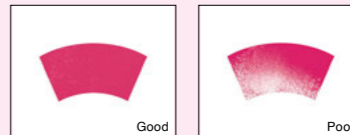
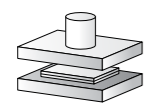
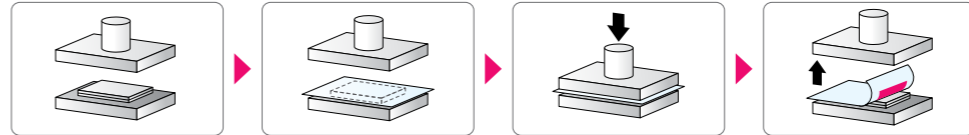
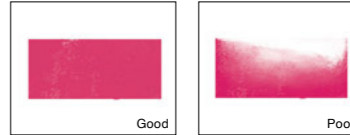
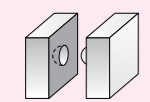
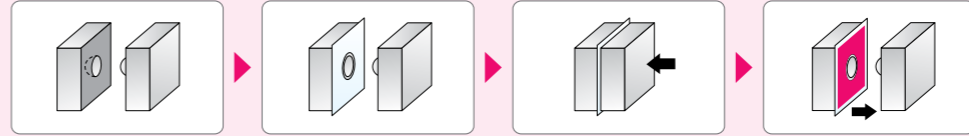
- * Select the curve A, B or C according to the condition (temperature and humidity) it is used
- * For continuous pressure of 5LW, 4LW and LLLW, time to reach pressure is set 5 seconds and time of retention at the pressure is set 2 min.
- * For HHS, there is only color chart for continuous pressure.

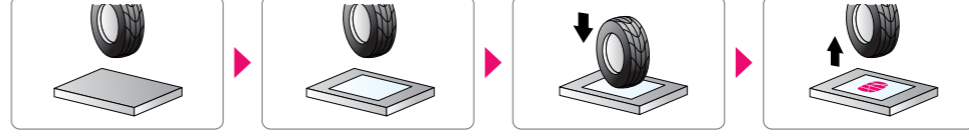
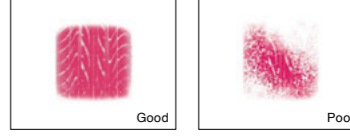
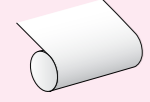
Accuracy and Recommended Temperature / Humidity When Used

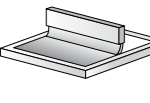
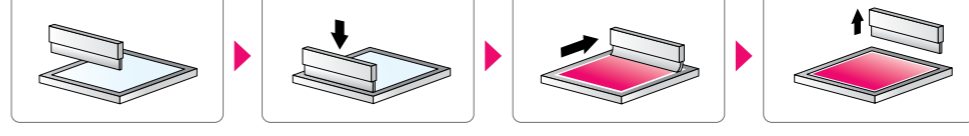
Prescale (two-sheet type / mono-sheet type)	
Accuracy	±10% or less (when measured at 23°C, 65%RH by concentration measuring apparatus)
Recommended temperature	20°C~ 35°C *1
Recommended humidity	35%RH ~ 80%RH *2 *3

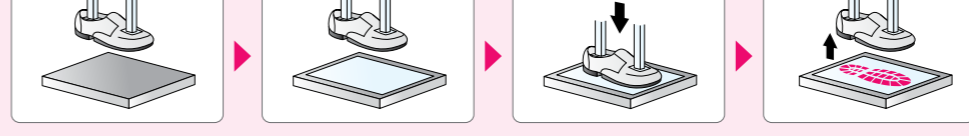
- *1 5LW/4LW/HHS: 15°C~30°C
- *2 5LW/4LW: 20%RH~75%RH *3 HHS: 35%RH~70%RH

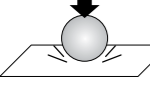
Wide Range of Applications and Measurement Techniques

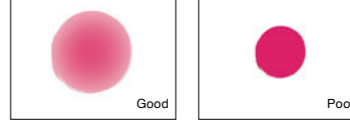
Examples of measurement types	Industries	Applications	Measurement methods	Measurement results
 <p>Nip pressure</p>	<ul style="list-style-type: none"> ● Pulp & Paper ● Chemical ● FPDs ● Touch panels ● Semiconductor ● Office machine 	<ul style="list-style-type: none"> ● Pressure between nip rolls and calendar rolls, e.g., paper machines, coating machines ● Pressure between electrophotographic neat fixing parts ● Pressure between embossing rolls ● Pressure between lamination rolls ● Nip pressure of high-performance films ● Bonding pressure of polarizing plates,OCA or Cover glass ● Bonding pressure of BG tapes ● Bonding pressure of DFR lamination ● Nip pressure of coating machine for electrode ● Conveyor nip roll pressure 		
 <p>Roll/plate contact pressure</p>	<ul style="list-style-type: none"> ● PCBs ● Electronics ● Li-ion battery 	<ul style="list-style-type: none"> ● Pressure of fastened surfaces, e.g., engines, gearboxes, turbines, valves, pumps, hydraulic, cylinders, bolted joints and compressors ● Sealing performance of gaskets, seals, and O-rings 		
 <p>Tightening pressure</p>	<ul style="list-style-type: none"> ● Automobile ● Machinery ● Aerospace 	<ul style="list-style-type: none"> ● Pressure of fastened surfaces, e.g., engines, gearboxes, turbines, valves, pumps, hydraulic, cylinders, bolted joints and compressors ● Sealing performance of gaskets, seals, and O-rings 		
 <p>Contact pressure</p>	<ul style="list-style-type: none"> ● Automobile ● Electronics 	<ul style="list-style-type: none"> ● Contact pressure of brakes, clutch plates, and pistons ● Contact pressure of spot-welding machines ● Contact pressure of IC heat sinks 		
 <p>Compression pressure</p>	<ul style="list-style-type: none"> ● PCBs ● Ceramic devices ● FPDs ● Semiconductor ● Photovoltaics ● Fuel cell ● Smartphones ● Electronics ● Aerospace ● Conveyor belt 	<ul style="list-style-type: none"> ● Bonding pressure of laminated print substrates ● Bonding pressure for laminated ceramic devices ● Bonding pressure for LCD panels ● ACF bonding pressure ● Press pressure of vacuum laminator ● Bonding pressure of fuel cell stacks ● Bonding pressure of smartphones ● Composite layup pressure ● Wafer bonding pressure ● Bonding pressure of vulcanizers 		
 <p>Contact conditions</p>	<ul style="list-style-type: none"> ● Machinery ● Automobile ● Packaging ● Li-ion battery ● Semiconductor ● Injection molding ● Printing 	<ul style="list-style-type: none"> ● Contact condition of press dies ● Balance checking of press machines ● Contact condition of heat seal bars ● Contact condition of press machines for adhesion ● Contact condition of CMP polishing head ● Contact condition of suction jig for die bonding ● Contact condition of molds ● Blanket cylinder pressure of printing machines 		
 <p>Support pressure</p>	<ul style="list-style-type: none"> ● Automobile 	<ul style="list-style-type: none"> ● Support pressure for tires and caterpillar tracks ● Support pressure for machines, bridge beams, and tanks 		
 <p>Winding pressure</p>	<ul style="list-style-type: none"> ● Pulp & Paper ● Chemical 	<ul style="list-style-type: none"> ● Winding pressure for high-performance films and paper ● Winding pressure of coils 		
 <p>Squeegee pressure</p>	<ul style="list-style-type: none"> ● PCBs ● Ceramic devices ● Electronics ● Printing ● Photovoltaics 	<ul style="list-style-type: none"> ● Squeegee pressure for screen-printing e.g., print substrates, green sheets for ceramic devices 		
 <p>Medical pressure</p>	<ul style="list-style-type: none"> ● Medical 	<ul style="list-style-type: none"> ● Pressure on soles of human feet and on soles of shoes ● Cavitation pressure ● Orthopedics ● Bone plate pressure, bone joint pressure, tooth alignment and pressure, mastication analysis, biomedical, and ergonomics 		
 <p>Impact pressure</p>	<ul style="list-style-type: none"> ● Others 	<ul style="list-style-type: none"> ● Functional testing of equipment for baseball, golf, etc. ● Package drop testing ● Impact pressure of water jets ● Pressure on freight during transportation ● Impact pressure on bumpers and airbags 		

* Refer to details of Prescale types on the back for measurable pressure range

Fuji Digital Analysis System for Prescale

FPD-8010E



Colorized Prescale is digitized using a scanner and converted into numerical data by software. Various pressure analyses can be conducted.

The FPD-8010E converts Prescale pressure values into numerical data and is a pressure mapping analysis system that allows various methods of analysis. In order to make Prescale data even more useful, we will meet your requirements for converting to numerical data, saving data and performing data analysis.



Functions

Overall Measurement

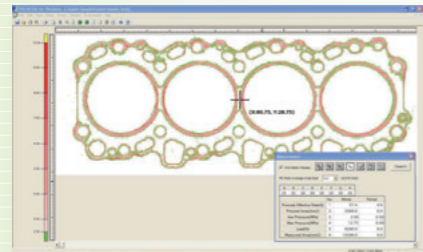

Various data such as average pressure and maximum pressure are displayed.

Partial Enlargement

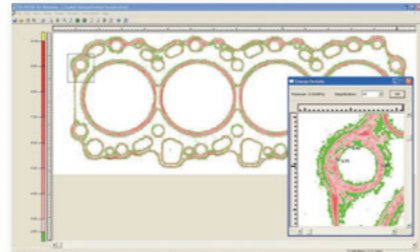

The specified field is enlarged. (x4,x8,x16) Pin point pressure values can be displayed on the image.

Changing the pressure Bar Setting

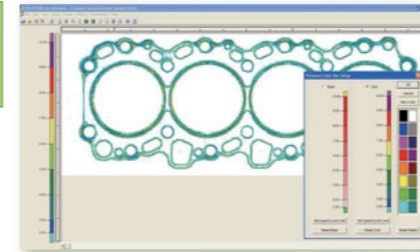

The colored pressure bar and the pressure bar boundary can be changed.

Text Data Output

Pressure data is exported to a text file.

Pressure Cross Section

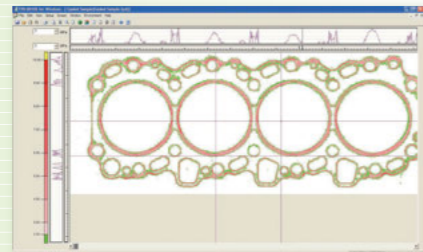

Pressure distribution on a line passing through a specified point is shown on a line graph.

Wire Frame

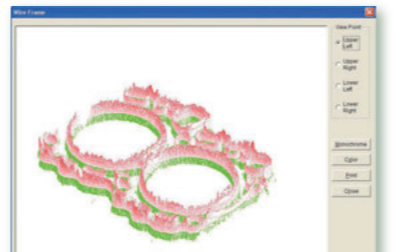

Pressure is displayed in 3-D format.

Pressure Distribution Animation

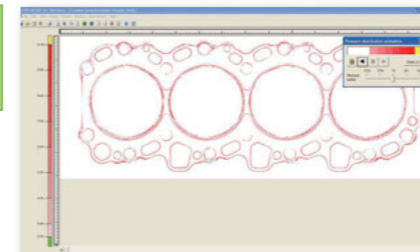

Step-by-step pressure values are displayed in an animated format.

Total Weight Distribution

The upper and left segments of the total pressure are displayed on a bar graph.

Histogram Analysis

Pressure on the circumference is displayed as a histogram.

Printing and Saving

The displayed screen and data can be printed. After stored data is re-loaded and displayed, you can store it.

Specifications

Product Name	FUJIFILM PRESSURE DISTRIBUTION MAPPING SYSTEM for PRESCALE
Model	FPD-8010E
Main Functions	Pressure analysis Pressure data output function Partial Zoom function Excess length synthesis function
Scan Sizes	Single Read : 297mm x 210mm (11.7 in x 41.3 in) Maximum : 891mm x 1050mm (35.1 in x 41.3 in)
Resolution	0.125 (200dpi), 0.25 (100dpi), 0.5, 1, 2mm sq.
Scanner	Epson A4 Scanner. Perfection V37/V370, Perfection V600/V850

Recommended Software Environment

OS	Windows 8, 8.1, 10 (32 / 64bit)
CPU	more than 1GHz
Memory	more than 2GHz
HDD	available capacity must be more than 32GB
Display	1024x768 60,000 colors or more

Visual Evaluation (Reference Chart)

Using Prescale with the reference charts allows visual evaluation. Using the reference charts provided for each product type makes it possible to measure pressure values by viewing the Prescale color density.

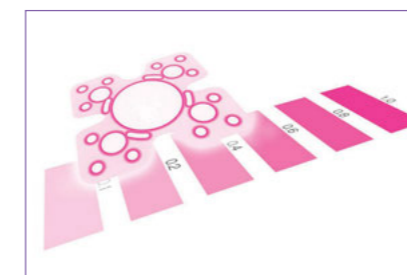

Visual evaluation of density from standard color samples.

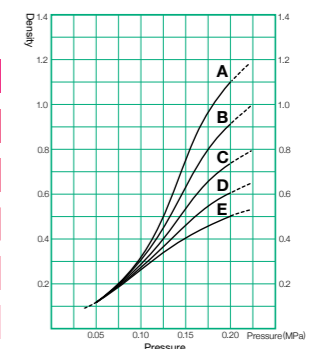
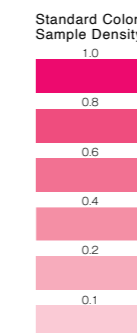

Visual Chart

Pressure Image Analysis App

FUJIFILM Prescale Mobile

The app that enables any user to quantify pressure and other analysis results with ease.

Prescale Mobile is a dedicated app that enables easy quantification of pressure by capturing the colored Prescale with mobile device. You can also register and inspection images against your own boundary sample.

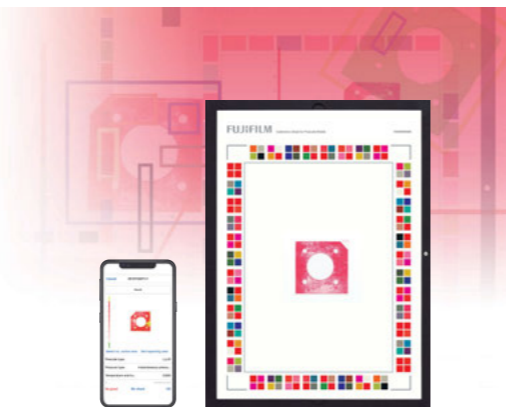

Functions

1 Pressure Measurement

Inspection areas of the desired size can be specified up to six positions, and inspection information inside these areas can be displayed.

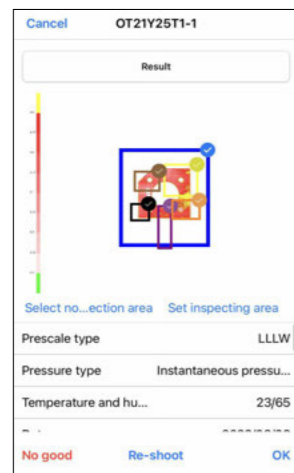

2 Comparison

Sample and inspection images can be displayed side-by-side.
* This function can only be used with Individual Inspections.

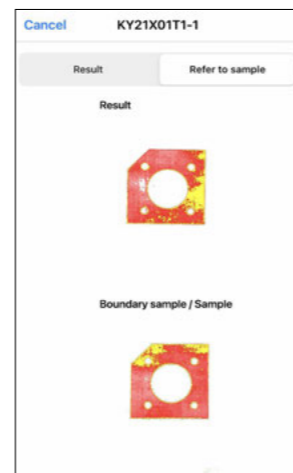

3 Superimposition

The boundary samples and inspection images can be layered over each other to show differences in pressure. The color bar on the left indicates the degree of conformity between the pressure in the boundary sample and inspection images.
* This function can only be used with Superimposition inspection.

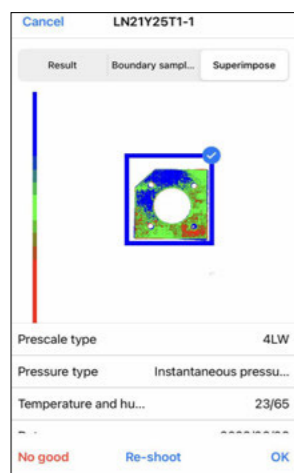

4 Auto Judgement

It is automatically judged based on the preset threshold value or threshold range.

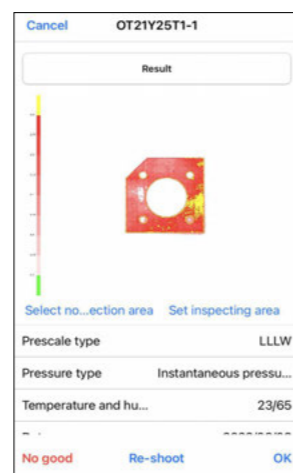

5 Data Storage

Data can be stored, and past record can be referenced at any time.

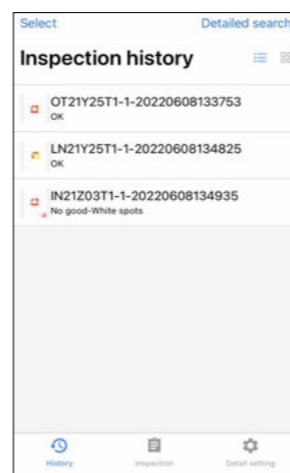

Inspection Workflow

Once the sample is registered, it can be easily inspected.

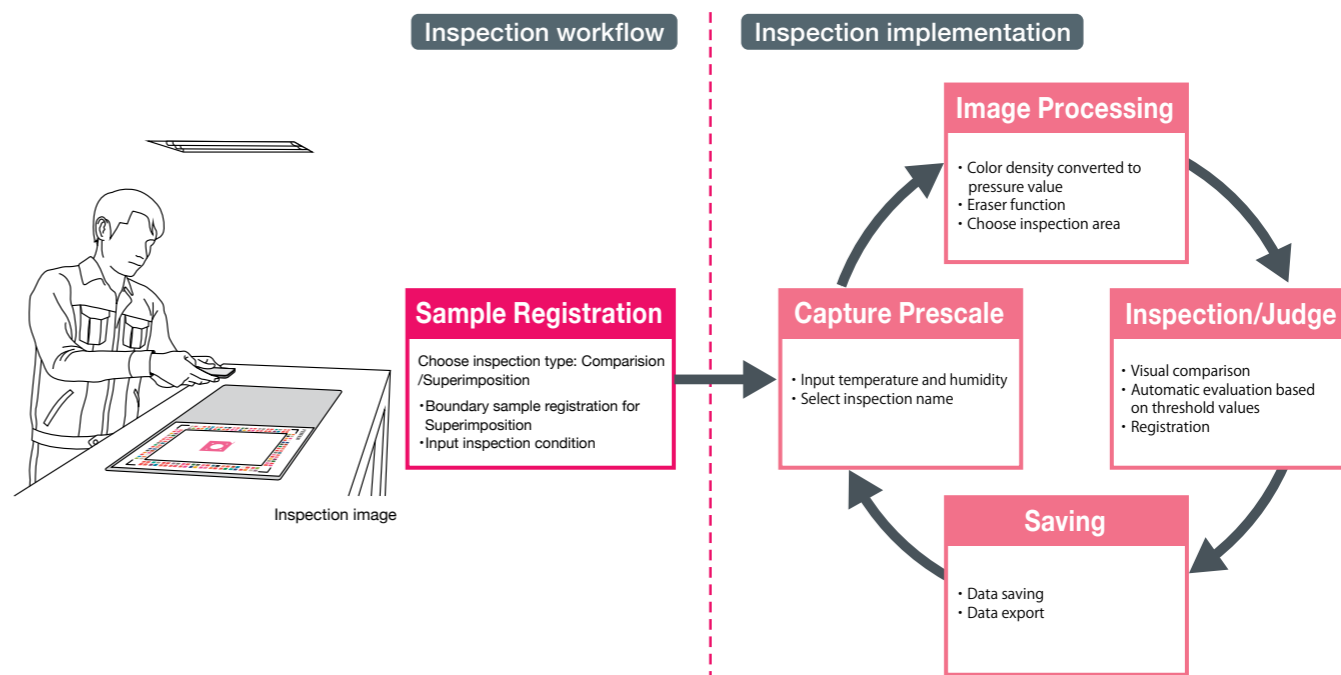

Supported Measurements

Item	Unit	Explanation
Effective Rate	%	The percentage of the colored area within the recommended pressure range for the applicable Prescale
Pressured area	mm ²	The colored area
Average pressure	MPa	The average pressure of colored area
Maximum pressure	MPa	The maximum pressure of colored area
Minimum pressure	MPa	The minimum pressure of colored area
Weight	N	The weight is colored area multiplied with average pressure
Measured surface area	mm ²	Specified inspection areas
Uniformity (pressure)	%	An index indicating the uniformity of pressure value on the colored area
Uniformity (density)	%	An index indicating the uniformity of color density

Main specifications

Specifications

Product name	FUJIFILM Prescale Mobile
Items included	2 calibration sheets, Folder (cardboard), License handbook, 10 protective sheets
Usable Prescale	LW, LLW, LLLW, 4LW, Prescale for High Temperature LLW
Functions	Pressure measurement, Comparison, Superimposition, Auto Judgement, Data Storage, etc.
Readable size	Up to A4

Supported devices

Supported devices	iPhoneSE 2th/3th generation
OS	15.1.2 or above
Memory	64GB or above

* Mobile devices are not included with the product and should be purchased separately by the customer.

* Please check the website for the latest information.

Please check the website for details.

FUJIFILM Prescale Mobile

Pressure Measurement Film

Prescale for High Temperature LLW

The new Prescale for High Temperature can be used during heat pressing and other heat-based processes.



Benefits of Prescale for High Temperature

Standard Prescale

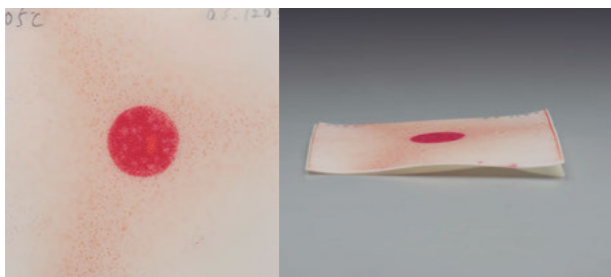

Prescale for High Temperature

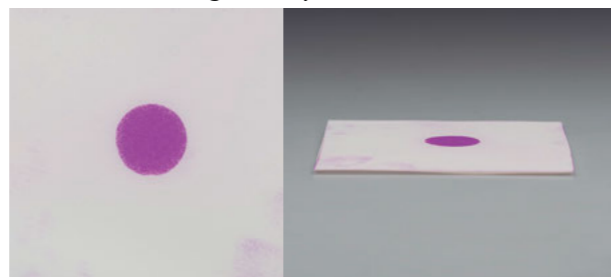

* This is an image

- Heat-induced color development and base deformation are significantly reduced compared to standard Prescale products.
- Enables accurate pressure distribution measurement under conditions closer to actual manufacturing conditions.
- Reduces required heating and cooling time for manufacturing equipment, contributing to improved productivity.

How It Works

This product consists of two film types: A-film is coated with a layer of micro-encapsulated color forming material. C-film with a layer of the color developing material. Use two films facing the coated sides each other. When pressure is applied, the microcapsules are broken and the color-forming material reacts with the color-developing material to make red color. The microcapsules are designed to break according to the pressure so the color density corresponds to the pressure.

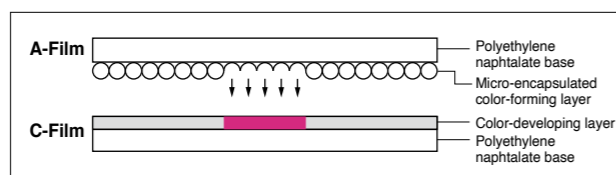

Please check the website for details.

[Prescale for High Temperature](#)

How to Use

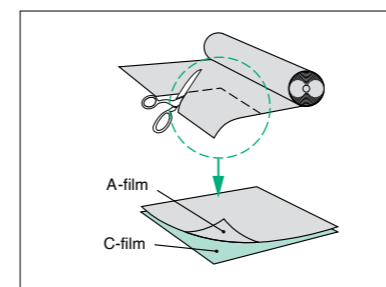

(1) Cut the Prescale to the shape to be measured

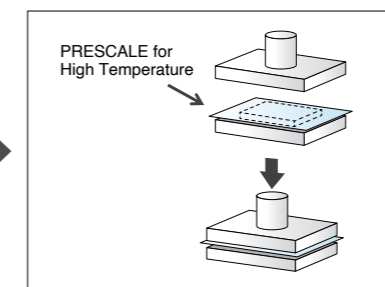

(2) Place the cut Prescale in the measurement location and apply pressure

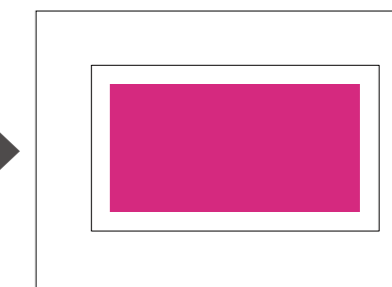

(3) Remove the film and visually inspect the pressure distribution

Specifications

Product size	270mm x 6m
Pressure range	0.5MPa~2.5MPa / 73~363psi
Recommended heating temperature	180°C~220°C / 356~428°F (double-sided heating)
Accuracy	±10% or less (measured by densitometer)

Pressure values under high-temperature conditions can be confirmed visually by checking the color chart included with the product.

Application Examples

Example of measurement types	Industries	Applications
<p>Heat press pressure</p>	<ul style="list-style-type: none"> - Automotive - Injection molding - Electronics etc. 	<ul style="list-style-type: none"> - Check the level and distribution of pressure applied by heat press.
<p>Heated nip pressure</p>	<ul style="list-style-type: none"> - Li-ion battery - PCB - Ceramic devices - Electronics etc. 	<ul style="list-style-type: none"> - Check the pressure applied by heated rollers and laminators.
<p>Heat sealing pressure</p>	<ul style="list-style-type: none"> - Food - Pharmaceutical - Other packaging etc. 	<ul style="list-style-type: none"> - Check heat-sealing devices for misalignments and distortions.
<p>Heated lamination pressure</p>	<ul style="list-style-type: none"> - PCV - Ceramic devices - Li-ion battery - Electronics etc. 	<ul style="list-style-type: none"> - Check the evenness and uniformity of contact of high-temperature laminator molds.
<p>Compression pressure</p>	<ul style="list-style-type: none"> - PCB - Li-ion battery - Electronics etc. 	<ul style="list-style-type: none"> - Check the level and distribution of pressure applied by high-temperature compression press. - Check the compression pressure during charging and discharging processes under high-temperature conditions.

Heat Distribution Measurement Film

THERMOSCALE

THERMOSCALE is a revolutionary new film that enables anyone to measure heat distribution easily by observing the variation in density and hue.



Structure

The base film is coated with a thermosensitive color-forming layer and a protective layer. This is the non-glossy surface that comes into direct contact with the heat source. The glossy side of the sheet is used to observe the color patterns that represent heat distribution.

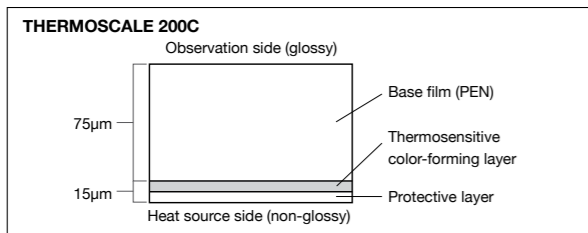

How It Works

Heat melts the developer and makes the microcapsule walls permeable, allowing developer to enter the microcapsules, where it reacts with the color-forming agent to produce color.

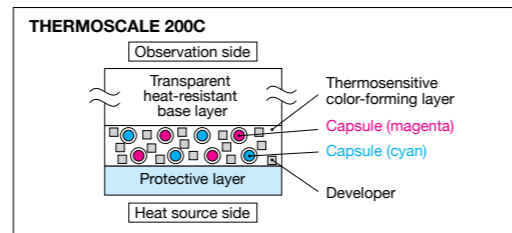

How to Use

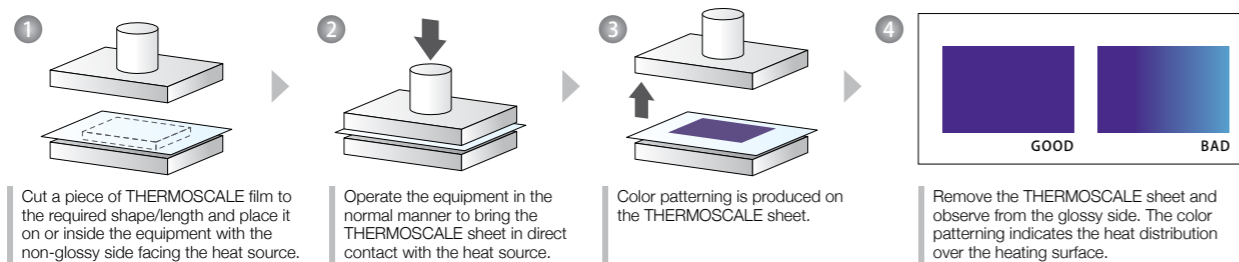

Features

THERMOSCALE 200C

The extent of color depends on the temperature of the heat source and the contact time. A shorter contact time produces paler colors with a blue tint. As the contact time increases (at the same temperature), the colors become deeper and take on a red tint. Note that the color change is also influenced by factors such as the type of material on the opposite side (i.e., the non heat source side), thermal characteristics, contact pressure and air flow (see below).

	150	160	170	180	190	200	210 °C
Contact for 1 second	[Light blue]	[Light cyan]	[Cyan]	[Dark cyan]	[Blue]	[Dark blue]	[Purple]
Contact for 10 seconds	[Cyan]	[Dark cyan]	[Blue]	[Dark blue]	[Purple]	[Dark purple]	[Magenta]
Contact for 60 seconds	[Dark cyan]	[Blue]	[Dark blue]	[Purple]	[Dark purple]	[Magenta]	[Dark magenta]

* Note: The above sample colors were produced by Fujifilm under test conditions. Calibration should be performed under actual usage conditions to ensure temperature correspondence.
Recommended temperature range: 15°C-30°C Recommended humidity: 35% RH-80% RH

THERMOSCALE 100

	80	85	95	105 °C
Contact for 1 second	[Light grey]	[Light grey]	[Light grey]	[Light grey]
Contact for 10 seconds	[Light grey]	[Light grey]	[Light grey]	[Light grey]
Contact for 60 seconds	[Light grey]	[Light grey]	[Light grey]	[Light grey]

* Note: The above sample colors were produced by Fujifilm under test conditions. Calibration should be performed under actual usage conditions to ensure temperature correspondence.
Recommended temperature range: 15°C-30°C Recommended humidity: 35% RH-80% RH

Color of THERMOSCALE sheet turns black when coming in contact with the heat source. A shorter contact time produces paler colors. As the contact time increases (at the same temperature), the colors become deeper. Note that the color change is also influenced by factors such as the type of material on the opposite side (i.e., the non-heat source side), thermal characteristics, contact pressure and air flow (see below).

Typical Applications

THERMOSCALE 200C

1 ACF compression bonding in LCD panels

In LCD panel production, ACF (anisotropic conductive film) is used to attach the driver IC by holding the part under pressure and applying heat via the bonding tool. If heat is unevenly distributed across the bonding surface (i.e., hotter in some places and cooler in others), the ACF may not bond properly. THERMOSCALE provides an easy-to-read visual map for evaluating the uniformity of heat distribution.

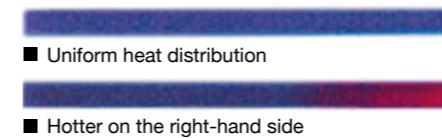
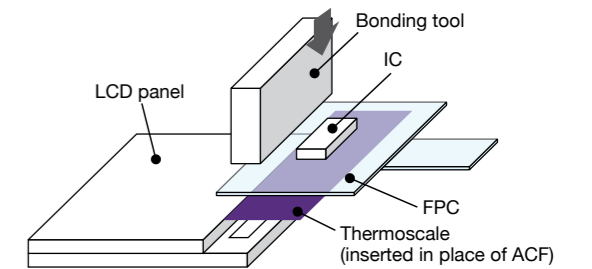

2 Heat-sealed packages

Heat sealers are commonly used to seal packages for foodstuffs, medical supplies and products such as Li-ion batteries. A heater block applies strong heat to the end of the package to seal the plastic. If heat is distributed unevenly across the heat seal surface or the heater block, or if the packaging is not heated sufficiently, the seal may not be formed properly. THERMOSCALE can be used to evaluate the quantity of heat applied to the package.

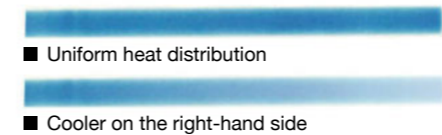
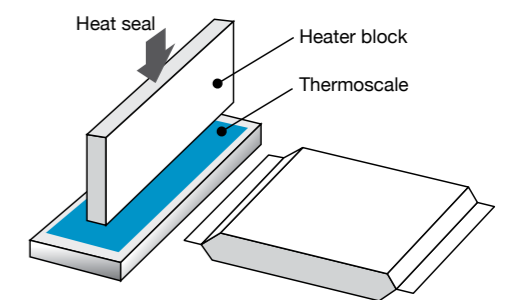

Copier: Heat fusion

In general laser copiers (multifunction printers) used in offices, fusion rollers—which are heated—use heat to melt toner and fuse it to paper to portray letters and pictures, etc. However, if heat is unevenly distributed or if there are scratches on the surface of the fusion roller, copying cannot be carried out properly. By using THERMOSCALE, you can determine if there are any heat irregularities or slight scratches on the surface of the fusion roller.

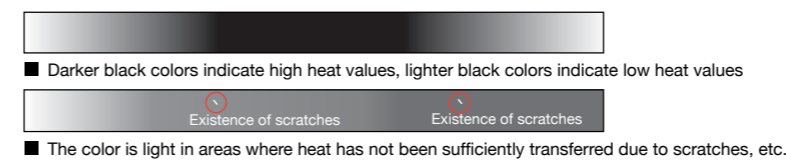
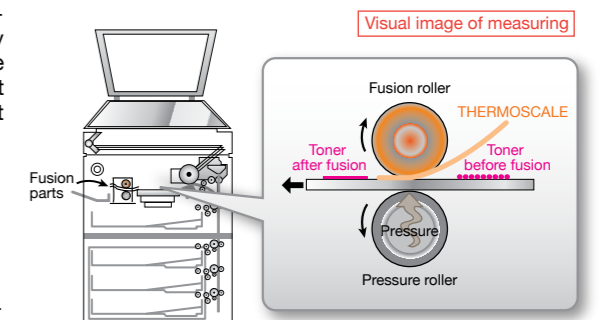

Uses

THERMOSCALE uses special technology that regulates color intensity and hue in accordance with heat value to generate a highly accurate depiction of heat values over a wide range. THERMOSCALE is ideal for applications involving analysis of heat distribution during press, roll, and laminate processes and within drying ovens.

Laminator

Printed substrates, solar panels, protective film laminating

Press

ACF compression bonding, heat seals, Li-ion batteries, solar panels

Roll

Nip roll, calendar roll, printing roll, printer roll

Ovens

Drying oven, baking oven, vacuum film production, measuring surface heat distribution on parts

Specifications

Product	Temperature range	Base layer	Thickness	Size	
				Roll Type (width × length)	Sheet Type (height × width)
THERMOSCALE 200C	150°C-210°C *1	PEN	0.09mm	270 mm × 5 m	270 mm × 200 mm (5 sheets)
THERMOSCALE 100	80°C-105°C *2	PET		297 mm × 10 m	—

* Actual temperature range depends on conditions of use including contact time, materials, pressure, and air flow. *1 Contact time = 5-20 sec *2 Contact time = 1-10 sec

Ultraviolet Light Amount Distribution Measurement Film



Visualizes UV light amount distribution by color density



How It Works

Structure

One side of the base film has a UV light sensitive layer, with the opposite side having a white-colored layer. The light sensitive layer changes color according to the amount of UV light it receives, so the amount of light distributed on the exposed surface is easily seen by observing a light sensitive layer and white-colored layer are attached to the base. Since the color density of the white-colored layer corresponds to the amount of UV light received, the light amount distribution on the light receiving surface can easily be investigated.

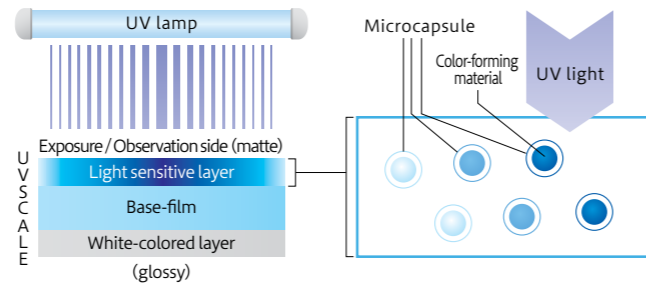

Principle

The color forming material in the microcapsules reacts to the UV light and changes color.

How to Use



- After cutting UVSCALE to the required shape (length), place it on the location that you want to measure.
- Operate the equipment or device, and expose UVSCALE to UV light.
※The side of UVSCALE with matt surface should be exposed.
- UVSCALE changes color in accordance with the amount of light.
- Remove UVSCALE, and determine the distribution of light by observing the color distribution.
※Use the matte side for observing.

Check Method 1: Visual check with standard color charts

Standard Color Chart

[High-pressure mercury lamp]

The figure on the right represents color characteristics generated by a high-pressure mercury lamp. However, please note that these color characteristics are values generated by using FUJIFILM light source and devices, so there may be differences in color density for a given amount of light due to difference and variations in individual lamps or environment.

Advantages of visual checks

- Referring to standard color charts makes it possible to visually judge accumulated light amount values in an easy way.
- Providing color samples can significantly reduce the time necessary for checking UV light amount when starting work and switching objects to be exposed.

※1: Each density is the value measured by FUJIFILM. It is not a warranty of density level.
 ※2: The amounts of UV-light are values using a 365 nm UV illuminometer.
 ※3: The solid lines on the graph show the recommended measurement range. The broken lines represent values that are not as precise as the solid lines and should be used as a reference only.
 ※4: Standard Color Samples show the density range for visual evaluation.

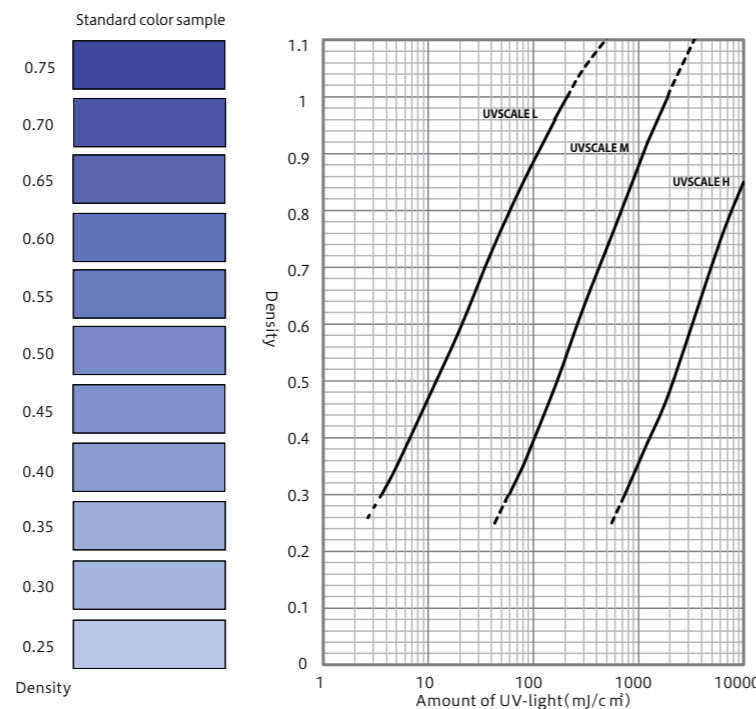

Specifications

UVSCALE specifications

We are offering three types of UVSCALE based on accumulated light amount.

Type	Product size		Light Level	Light reduction film	Thickness
	Roll type	Sheet type			
UVSCALE LM	270mm × 5m	270mm × 200mm (5 sheets)	Low (UVSCALE L)	Non-use	0.1mm
			Medium (UVSCALE M)	use	0.1mm×2
UVSCALE H			High (UVSCALE H)	use	0.1mm×2

Light amount measurement range

Measurable lamp	Type	Light Level	Effective light amount measurement range ^{※1} (mj/cm ²)
High-pressure mercury lamp	UVSCALE LM	Low (UVSCALE L)	4-200
	UVSCALE H	High (UVSCALE H)	800-40000
Metal halide lamp	UVSCALE LM	Low (UVSCALE L)	6-200
	UVSCALE H	High (UVSCALE H)	700-20000
Low-pressure mercury lamp	UVSCALE LM	Low (UVSCALE L)	20-3000
UV-LED lamp (365 nm)	UVSCALE LM	Low (UVSCALE L)	200-6000
	UVSCALE H	High (UVSCALE H)	5000-100000

※1: The measurement ranges mentioned above is when FUD-7010E is used.
 The light amount range that can be visually checked is the density on standard color samples (0.30 to 0.75).
 ※Applies to wavelengths in the 200 to 420 nm range ※This does not guarantee the absolute values of UV light amount values.

FUD-7010E specifications

Product name	FUJIFILM UV LIGHT DISTRIBUTION MAPPING SYSTEM for UVSCALE
Model	FUD-7010E
Items included	Exclusive software (CD-ROM), Dedicated cover, Calibration sheet
Usable UVSCALE	UVSCALE L, UVSCALE M, UVSCALE H
Measurable UV lamp	High-pressure mercury lamp, metal halide lamp, low-pressure mercury lamp, UV-LED (365 nm)
Main functions	Analyzing UVSCALE images (measuring accumulated light amount, displaying light amount distribution, saving data, data export)
Scan size	Depending on the scanner used
Resolution	0.125mm (200dpi) 0.03125mm (800dpi)

System requirements (software)

OS	Windows 8, 8.1, 10 (32 / 64bit)
CPU	more than 1GHz
Memory	more than 2GHz
HDD	Disk space: more than 32GB
Display	1024 x 768 60,000 colors or more

Scanner used for FUD-7010E

Scanner	please ask your dealer or fujifilm for the information of recommended scanner type
---------	--

※Scanners are sold separately and customers are to purchase them on their own.

※Please note that the specifications and performance stated in this catalog may change without prior notice as a result of improvements. The diagrams used are schematic, and differ from those for actual measurements.
 ※Microsoft Office Excel is a registered trademark of Microsoft US.

Check Method 2: Management by converting colors into numeric values with analysis systems
[Analysis system FUD-7010E]

In this system, exclusive analysis software is used along with a usable scanner.※ The system makes it possible to scan color of UV scales, convert it into UV light amount values, analyze UV light amount distribution, and save them.

※Scanners are sold separately and customers are to purchase them on their own.

Advantages of management with numerical values

- Analysis** The separation accuracy of density can be improved, so sections that cannot be visually judged can be analyzed.
- Standardization** Internal inspection standards can be set.
- Sharing** Analysis results can be shared.
- Data saving** Digitizing data makes it possible to compare it to past data.

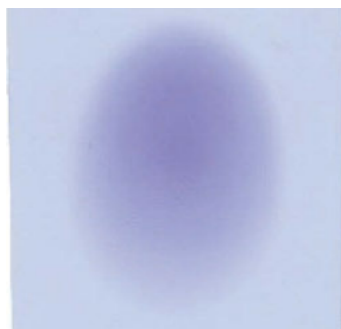
[How to use an analysis system]

①Irradiate light to a UVSCALE.



②Set UVSCALE on the scanner (recommended model) and scan the color sample.

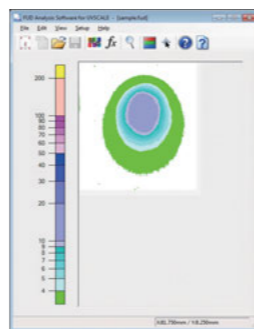

③Analyze it on a PC in which the exclusive software has been installed.

Calibration

Use a calibration sheet to correct variations caused by differences in scanners and conditions as much as possible and to stabilize measurement results.

Setting measurement conditions

Select UVSCALE type used, light source lamp, and sample name to be saved on the new creation screen.

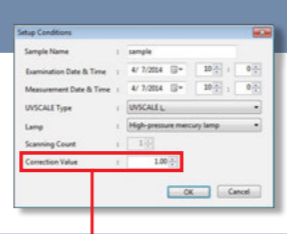
Correction Value Setting

Entering a correction value can correct differences in light amount values caused by differences in illuminometers, temperature, and other measurement conditions to obtain an appropriate value.

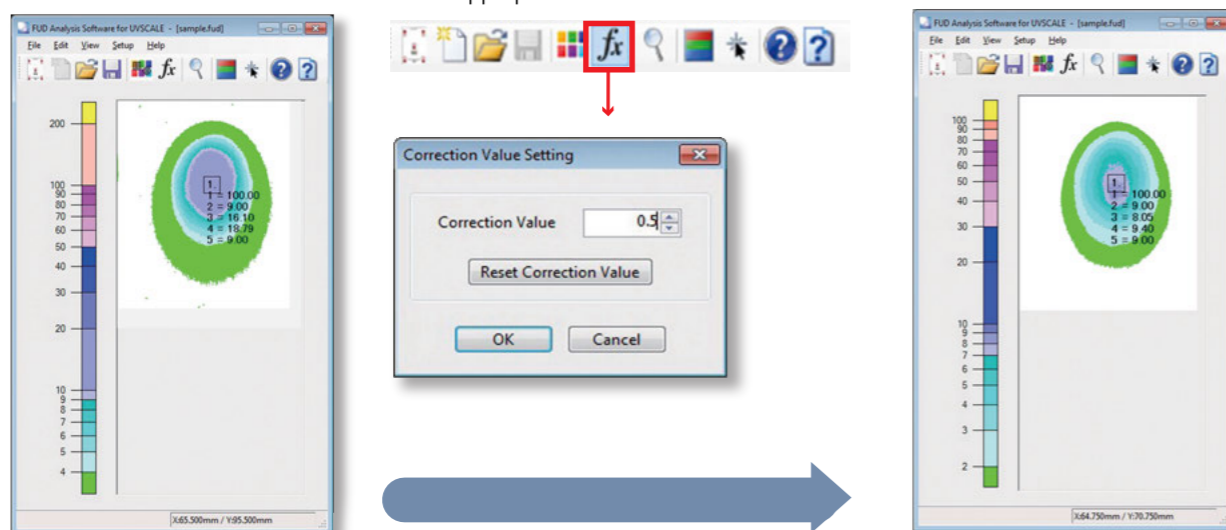

[Analysis system measurement features]
Division Color Bar Setup

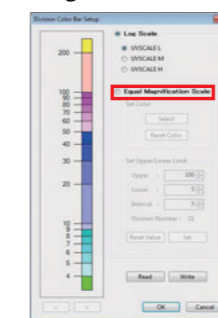
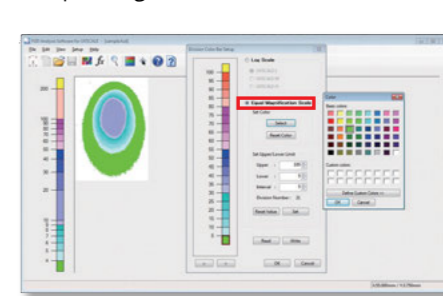
Light amounts measured are illustrated in a graph by colors. Various settings, such as scale type (log scale, equal magnification scale), upper and lower limits of scale bars, intervals, and color, can be freely set based on measurement conditions.

[Log scale]

[Equal Magnification scale]

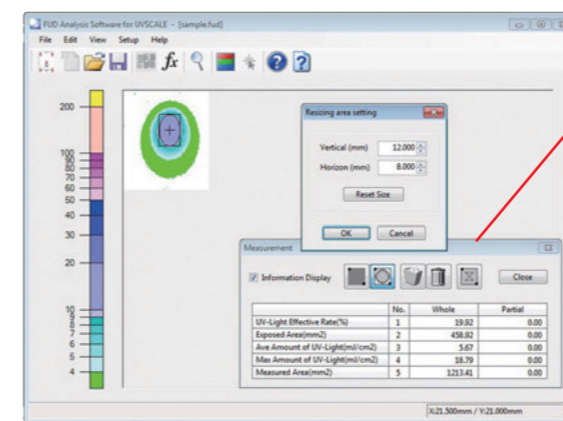
Measuring light amount

Data imported is converted into numerical values. Measurement data of the entire section and section specified with a rectangle or circle is displayed.

UV-Light Effective Rate (%)	Percentage of the area that is between the displayed lower-limit division color bar and the upper-limit division color bar inclusive
Exposed Area(mm ²)	Area where color came out
Ave Amount of UV-light(mj/cm ²)	Average light amount in the measurement range
Max Amount of UV-light (mj/cm ²)	Maximum light amount in the measurement range
Measured Area (mm ²)	Area of the measurement range

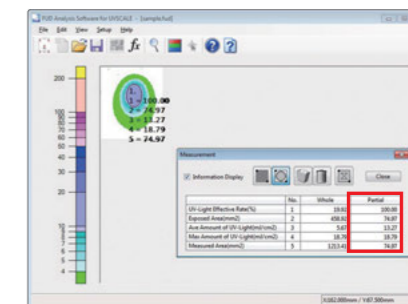

Measurement data of the specified section is displayed.

Rectangular Area Data Export Function

Results of partial measurement (rectangle) can be output in text data. Using Excel to graph the results—as shown on the right—makes it possible to see the light amount distribution in a way that is easy to understand.

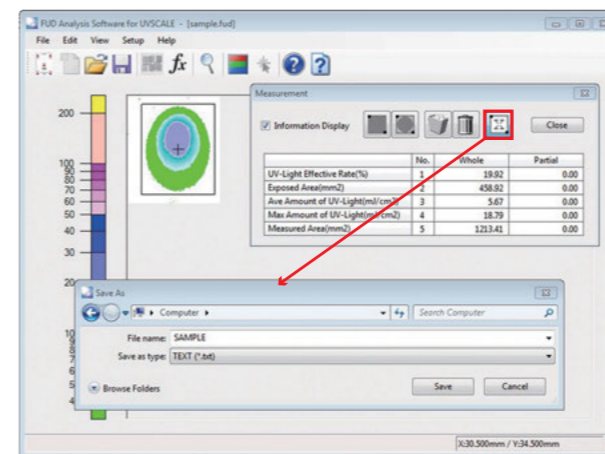

Graph on Excel generated from the data

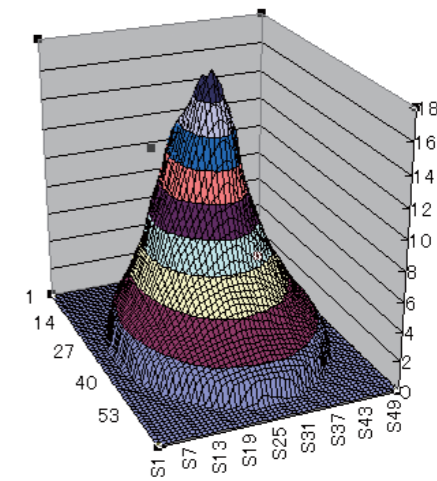

Typical Applications

1 UV sterilization

Measuring the amount of UV light when milk cartons are sterilized.

Cartons are assembled → Irradiated with UV light

Results

- Insufficient amount of light
- Insufficient amount of light

Benefits

- UVSCALE allows the amount of UV light on the side faces and in the bottom corners of food packages, where illuminometers cannot be used because of the reductions in light that may occur.
- Exposed UVSCALE can be stored and used to trace product quality.

2 UV painting

Checking the distribution of UV light automotive parts are exposed to

Results

- Some sections are exposed to low amounts of UV light.
- The light amount is not appropriate due to deterioration of the lamp.

Benefits

- Capable of measuring light and checking light amount distribution on three-dimensional objects for which illuminometers cannot be used to measure light, sections into which illuminometers cannot fit, and sections that are moving while light is being irradiated.
- Useful for adjusting how to place products and how to irradiate light because sections that become shadows of three-dimensional objects can be checked with density.

3 UV coating

Measuring UV light distribution in the width direction of the coating for roll conveyor systems

Results

- UV light is distributed in the width direction. The light amount is small, so it is not appropriate.

Benefits

- Capable of measuring light amount during roll conveyance in which illuminometers cannot be used to measure light amount.
- Capable of measuring and checking distribution in the width direction immediately (on an entire surface), thus allowing measurement to be completed in one test and the time needed for making adjustments and assessments to be reduced.

4 UV bonding

Checking UV light distribution on a conveyor belt during the OCR attachment process of touch panels

Results

- Was able to check unevenness of UV exposure in sections where the light from multiple point sources overlap.

Benefits

- Unevenness of UV exposure and decreases in the amount of light can be checked by observing the intensity of the color.
- Allows the height and position of UV lamps to be adjusted when equipment is installed.
- Allows checking of the time for replacing lamps.

5 UV printing

Results

- Some sections are exposed to low amounts of UV light.
- The light amount is not appropriate due to deteriorated lamp.

Benefits

- Reduction in the accumulated light amount due to degradation of UV lamps and dirt on reflective plates can be easily checked with density, which makes it possible to confirm that the lamps and reflective plates should be replaced and identify causes of problems if they occur.
- Attaching UVSCALE to the roll width direction of sheets and irradiating UV light while feeding the sheets makes it possible to check actual UV light amount distribution in the width direction.

Application Examples

Examples of application for specific purposes and industries are available for download at the website below.



Examples of Use for Specific Purposes

Examples of Use in Specific Industries